

WASTEWATER MASTER PLAN



2020





August 17, 2020

To Our Valued Customers:

Re: 2020 Wastewater Master Plan

On behalf of the Great Lakes Water Authority (GLWA), we are pleased to announce the release of the final Wastewater Master Plan (WWMP). The WWMP was created with incredible energy, insight, and direction from a broad cross section of our member partners working collaboratively with our team members and consultants and other regional stakeholders. The focus, approach and outcomes of the plan demonstrate the true spirit of the One Water Partnership that GLWA and our member partners are committed to for the benefit of southeast Michigan.

GLWA embarked on this planning effort in late 2015 during the formative period of GLWA's organizational stand-up. At that time, we reached out to our member partners, listened to their interests, needs, and concerns about the regional wastewater system. In keeping with our strong commitment to building collaborative partnerships with our member partners, an initial committee convened in 2015 to work with GLWA to develop the Request for Proposals (RFP) for a consultant to lead us through the development of the plan. That RFP was completed in June 2016, and in March 2017, CDM Smith was approved by the GLWA Board of Directors.

A Steering Committee was convened in April 2017 to move the effort forward, and in October 2018 a Regional Collaboration Group was established. In total, over 100 stakeholder representatives were engaged in this multi-year planning process. From 2017 to 2019, GLWA's Member Outreach Team facilitated over 100 meetings to identify, analyze, and review the wide variety of planning issues with our member partners and other key stakeholders, including SEMCOG, watershed groups, MDOT and EGLE. A draft plan was released in January 2020, and with more than 200 comments received and incorporated, we are pleased to be publishing the final plan.

Recognizing that 86 systems under separate jurisdictions are connected in this large regional system, while also acknowledging that the pipes of these systems do not recognize boundaries, for the first time, we have a comprehensive plan that provides a regionally integrated and adaptive planning approach to produce five outcomes for the region:

- Protect public health and safety
- Preserve natural resources and a healthy environment
- Maintain reliable, high quality service
- Assure value for investment
- Contribute to economic prosperity

The 2020 WWMP builds on the history of environmental progress in the region, achieved by GLWA, DWSD and our other members. The 40-year Plan proposes new investment in existing infrastructure assets, as well as a step-by-step approach for optimization of the system as a whole. These optimization efforts and asset improvements will continue to advance water quality in the region.

The WWMP was developed on the fundamental principal that new capital and operating investments should proceed incrementally and adaptively, using a phased implementation framework. With implementation flexibility built into the Master Plan, we have the tools to adaptively proceed as planned, confirming the benefits of our efforts, as we work through challenging financial circumstances.

With continued collaboration essential to achieving the WWMP's five outcomes, Member Outreach Work Groups will guide the implementation efforts. These Work Groups include:

- Regional Collaboration Group;
- Wastewater Analytics Task Force;
- Wastewater Best Practices;
- Regional Watershed Hub

Working in concert with GLWA, these work groups will maintain progress and communication among parties on a month-to-month basis. Early initiatives for the regional water quality monitoring program, regional operating plan, several "Quick Win" projects, collaboration with MDOT, the Long-Term CSO Control Plan, and improvements at the Water Resource Recovery Facility are already underway. Results of all efforts will be assessed at five-year intervals, with the WWMP going forward updated and adapted according to progress achieved.

Thank you to our many member partners, team members, and stakeholders who engaged with us in this effort. Your voices were incredibly valuable in shaping this plan. The WWMP holds tremendous opportunity for our region to leverage the infrastructure we have invested in to-date, as well as those identified future investments to achieve our desired outcomes.

We look forward to continuing to work with you through implementation of the WWMP.

Best Regards,

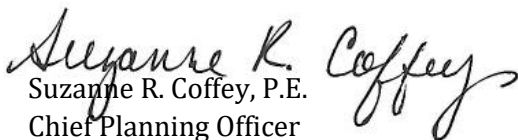
Suzanne R. Coffey, P.E.
Chief Planning Officer

Sue F. McCormick
Chief Executive Officer

Great Lakes Water Authority Wastewater Master Plan



In Association with:

Applied Science, Inc.
Alfred Benesch & Company
Clarifier Performance Evaluations
FK Engineering Associates
Fishbeck, Thompson, Carr & Huber, Inc.
HESCO
Alex McCorquodale, PhD
Onyx Enterprise, Inc.
Public Sector Consultants, Inc.
TetraTech of Michigan, PC

Cover Photographs

Upper Left: Pipe Penetrating Radar for Sewer Condition Assessment
Lower Left: Water Resource Recovery Facility Pump Station 1
Center: Water Resource Recovery Facility Secondary Clarifiers
Second from Right: Water Resource Recovery Facility Biosolids Dryers
Right: Oakwood Retention Treatment Basin Mechanical Screens



June 2020

Table of Contents

Section 1 Executive Summary	1-1
Historical Perspective	1-1
Challenges Ahead	1-1
Plan for the Future.....	1-3
Shared Desired Outcomes	1-3
Regional Collaboration Leads to Adaptive Integrated Plan	1-5
Major Recommendations of the Wastewater Master Plan	1-7
Collection System and Storm Sewer Best Practices	1-8
Why Is This Important?	1-8
What Will Be Done?.....	1-8
How Will It Be Implemented?.....	1-9
Regional Water Quality Monitoring Program	1-10
Why Is This Important?	1-10
What Will Be Done?.....	1-10
How Will It Be Implemented?	1-12
Regional Operating Plan.....	1-13
Why Is This Important?	1-13
What Will Be Done?.....	1-13
How Will It Be Implemented?.....	1-14
Water Resource Recovery Facility	1-15
Why Is This Important?	1-15
What Will Be Done?.....	1-16
How Will It Be Implemented?	1-16
Regional Collection System Rehabilitation and Asset Management	1-17
Why Is This Important?	1-17
What Will Be Done?.....	1-17
How Will It Be Implemented?	1-17
Green Stormwater Infrastructure and Sewer Separation.....	1-19
Why Is This Important?	1-19
What Will Be Done?	1-19
Clinton River and Lake St. Clair Water Quality.....	1-21
Why Is This Important?	1-21
What Will Be Done?.....	1-22
Rouge River CSO Control	1-23
Why Is This Important?	1-23
What Will Be Done?.....	1-23
How Will It Be Implemented?.....	1-24
Detroit River CSO Control.....	1-25
Why Is This Important?	1-25
What Will Be Done?.....	1-25
How Will It Be Implemented?	1-26
Implementation Summary	1-27
How Does the Adaptive Integrated Plan Manage Affordability?	1-27

Section 2 Planning Process and Report Introduction	2-1
2.1 Background	2-1
2.2 Mission Statement.....	2-1
2.3 Underlying Assumptions.....	2-1
2.4 Guiding Principles	2-2
2.5 Planning Process.....	2-3
2.6 Desired Outcomes	2-3
2.6.1 Protect Public Health and Safety.....	2-3
2.6.1.1 Measures.....	2-3
2.6.1.2 Data Collection and Analyses	2-3
2.6.2 Preserve (and Restore) Natural Resources and a Healthy Environment.....	2-4
2.6.2.1 Measures.....	2-4
2.6.2.2 Data Collection and Analyses	2-4
2.6.3 Maintain Reliable, High-Quality Service	2-4
2.6.3.1 Measures.....	2-4
2.6.3.2 Data Collection and Analyses	2-5
2.6.4 Assure Value of Investment	2-5
2.6.4.1 Measures.....	2-5
2.6.4.2 Data Collection and Analyses	2-5
2.6.5 Contribute to Economic Prosperity.....	2-6
2.6.5.1 Measures.....	2-6
2.6.5.2 Data Collection and Analyses	2-6
2.7 Report Introduction.....	2-6
Section 3 Regional System	3-1
3.1 General.....	3-1
3.2 History and Governance Structure	3-1
3.2.1 History.....	3-1
3.2.2 Governance Structure.....	3-3
3.3 Wastewater Service Districts	3-5
3.3.1 Rouge River Sewer District.....	3-10
3.3.2 Southfield Sewer District	3-11
3.3.3 Hubbell Sewer District.....	3-12
3.3.4 Oakwood Sewer District.....	3-13
3.3.5 Baby Creek Sewer District.....	3-14
3.3.6 Conner Creek Sewer District	3-16
3.3.7 Central Sewer District.....	3-17
3.3.8 Fox Creek Sewer District.....	3-19
3.3.9 East Jefferson Sewer District.....	3-20
3.3.10 City of Highland Park.....	3-21
3.3.11 City of Hamtramck.....	3-22
3.3.12 Rouge Valley Sewage Disposal District.....	3-23
3.3.13 Former Northeast Sewage Disposal System.....	3-24
3.3.14 City of Dearborn.....	3-26
3.3.15 City of Allen Park Sewer System	3-27
3.3.16 City of Melvindale.....	3-28

3.3.17	City of Grosse Pointe.....	3-29
3.3.18	City of Grosse Pointe Farms.....	3-30
3.3.19	City of Grosse Pointe Park.....	3-31
3.3.20	Other Small Wayne County Districts	3-32
3.3.21	Evergreen-Farmington Sewage Disposal District	3-33
3.3.22	Southeast Oakland County Sewage Disposal District.....	3-35
3.3.23	Clinton-Oakland Sewage Disposal System	3-36
3.3.24	City of Farmington Sewer District.....	3-37
3.3.25	City of Centerline Sewer District	3-38
3.3.26	Southeast Macomb Sanitary District.....	3-39
3.3.27	Macomb County Wastewater Disposal District.....	3-41
3.3.28	Michigan Department of Transportation.....	3-42
3.4	Summary of Combined Sewer Service Area	3-43
3.5	Water Resource Recovery Facility.....	3-54
3.5.1	Liquid Stream Treatment Processes.....	3-56
3.5.1.1	Raw Wastewater Pumping Stations Nos. 1 and 2 (Including Grit and Screenings)	3-56
3.5.1.2	Primary Treatment.....	3-57
3.5.1.3	Secondary Treatment.....	3-57
3.5.1.4	Disinfection.....	3-58
3.5.2	Solids Stream Treatment Processes.....	3-58
3.5.2.1	Gravity Thickening	3-59
3.5.2.2	Sludge Dewatering.....	3-59
3.5.2.3	Incineration	3-59
3.5.2.4	Biosolids Drying Facility	3-60
3.5.2.5	Central Offload Facility	3-60
Section 4 Regulatory Requirements		4-1
4.1	Overview.....	4-1
4.2	History of Regulations and Compliance	4-2
4.2.1	Great Lakes Water Quality Agreement	4-2
4.2.2	Clean Water Act.....	4-4
4.2.3	Michigan Drain Code.....	4-6
4.2.4	Consent Decree and Federal Oversight.....	4-8
4.2.5	Rouge River National Wet Weather Demonstration Project.....	4-9
4.2.6	Combined Sewer Overflows	4-10
4.3	Current Regulations and Compliance.....	4-12
4.3.1	Formation of the Great Lakes Water Authority	4-12
4.3.2	NPDES Permits.....	4-12
4.3.3	Administrative Consent Orders in the Region.....	4-16
4.3.4	Long-term CSO Control Plan.....	4-16
4.3.5	Industrial Wastewater Management	4-22
4.3.6	Water Resource Recovery Facility.....	4-23
4.3.6.1	Residuals Management Program.....	4-25
4.3.6.2	Air Permit	4-25
4.3.7	Green Stormwater Infrastructure	4-26

4.3.8	Municipal Separate Storm Sewer Systems (MS4)	4-26
4.3.9	Total Maximum Daily Loads (TMDLs)	4-27
4.4	Future Regulatory Compliance Landscape	4-27
4.4.1	Regional Approach to Achieving Clean Water Goals	4-28
4.4.2	Consolidation of Point Source Discharge Permits (Single Regional NPDES Permit)	4-28
4.4.3	Coordination of Nonpoint Source (Stormwater) Water Pollution Control Programs	4-29
4.4.4	U.S. EPA Integrated Planning Framework	4-31
4.4.5	Great Lakes CSO Notification Policy	4-33
4.4.6	Potential Future WWRF Regulations	4-33
4.4.6.1	Nutrients	4-34
4.4.6.2	Disinfection	4-34
4.4.6.3	Emerging Contaminants	4-34
4.4.6.4	Blending Policy	4-35
4.4.6.5	Residuals Management Program	4-35
Section 5 Planning Criteria		5-1
5.1	Overview	5-1
5.2	Regional Service Area	5-1
5.2.1	Datum	5-1
5.3	Planning Period and Related Time Periods	5-1
5.4	Population Projections	5-4
5.4.1	Regional Forecast Models for Population	5-4
5.4.1.1	Woods and Poole Economics, Inc. 2018 Regional Projection	5-4
5.4.1.2	Southeast Michigan Council of Governments	5-4
5.4.2	Regional Population Forecast Comparison	5-5
5.4.3	Population Extrapolations: 2045 through 2060	5-5
5.4.3.1	Information from First and Second Round GLWA Member Surveys	5-5
5.5	Wastewater Flows and Loads	5-13
5.6	Hydrologic Criteria	5-13
5.6.1	Continuous Simulations	5-14
5.6.2	Design Event Simulations	5-14
5.7	Development Driven Green Stormwater Infrastructure	5-16
5.8	Climate Resiliency	5-18
5.8.1	Detroit River Level	5-18
5.8.2	Climate Change Impacts in the Midwest and Great Lakes Region	5-20
5.8.3	Climate Change Implications for the GLWA's Wastewater Infrastructure	5-20
5.8.4	Analysis of Climate Models and Potential Changes to Rainfall Frequency, Duration and Intensity	5-21
Section 6 Collection System		6-1
6.1	Overview	6-1
6.2	Identification of Alternatives for Wet Weather Water Quality Protection	6-1
6.3	Root Cause Analysis	6-17
6.4	Screening of Candidate Solutions	6-22
6.5	Modeling of Regional Alternatives	6-23

6.6	Collection System Alternatives Scoring Methodology.....	6-26
6.6.1	Attainment Measures	6-26
6.6.2	Percent of Time Achieving Partial Body Contact Use	6-26
6.6.3	Percent of Time Achieving Full Body Contact Use	6-26
6.6.4	Percent of Time Achieving Aquatic Life Use	6-27
6.6.5	Percent of Rouge River Outfalls with First Flush Capture.....	6-28
6.6.6	Percent of Time Achieving Critical Hydraulic Grade Line	6-28
6.6.7	Percent Capture of Wet Weather Flow	6-28
6.6.8	Percent of Existing CSO Facilities Activated During Wet Weather Events.....	6-28
6.6.9	Asset Management Score.....	6-29
6.6.10	Contribution to Economic Prosperity	6-30
6.6.11	Weighting Factors for Attainment Measures	6-31
6.7	Scoring Results.....	6-31
6.8	Phasing of Proposed Projects.....	6-36
6.9	Collection System Capacity Assessment.....	6-37
6.9.1	Level of Service Goal	6-37
6.9.2	Potential Impacts of Climate Change	6-38
6.9.3	Critical Hydraulic Grade Line Elevations	6-38
6.9.4	Analysis of Trunk Sewer, Interceptor and Pump Station Capacity.....	6-42
6.10	Collection System Condition Assessment.....	6-44
6.11	Collection System Redundancy Assessment.....	6-45
Section 7 Water Resource Recovery Facility		7-1
7.1	Overview.....	7-1
7.2	Basic Planning Criteria.....	7-1
7.2.1	Flows and Loads	7-1
7.2.2	Permit Limits.....	7-8
7.2.3	System Models.....	7-10
7.3	Desired Outcomes and Performance Measures for WRRF.....	7-11
7.4	Influent Pumping and Preliminary Treatment.....	7-13
7.4.1	Introduction.....	7-13
7.4.2	Existing Conditions.....	7-14
7.4.2.1	Pump Station No. 1 and Associated Headworks	7-14
7.4.2.2	Pump Station No. 2 and Associated Headworks	7-18
7.4.3	Recent and Planned CIP Projects.....	7-20
7.4.4	Evaluation of Near-Term and Long-Term Upgrades to Pumping and Preliminary Treatment.....	7-21
7.4.4.1	Screen Technology Evaluation	7-21
7.4.4.2	Grit Technology Evaluation	7-22
7.4.5	Summary of Preliminary Treatment Alternatives	7-26
7.4.5.1	PS2 and Associated Preliminary Treatment Improvements	7-26
7.4.5.2	PS1 Preliminary Treatment Improvements	7-30
7.5	Primary Treatment.....	7-31
7.5.1	Introduction.....	7-31
7.5.2	Existing Conditions.....	7-32
7.5.3	Recent and Planned CIP Projects.....	7-33

7.5.4	Evaluation of Near-Term and Long-Term Upgrades to Primary Treatment	7-33
7.5.4.1	Ferric Chloride Addition Optimization.....	7-34
7.5.4.2	High Rate Clarification	7-35
7.5.4.3	Ongoing Asset Management	7-37
7.6	Secondary Treatment	7-37
7.6.1	Introduction.....	7-37
7.6.2	Existing Conditions.....	7-38
7.6.3	Recent and Planned CIP Projects.....	7-40
7.6.4	Evaluation of Near-Term and Long-Term Upgrades to Secondary Treatment	7-40
7.6.4.1	Optimization of Oxygen Activated Sludge System.....	7-40
7.6.4.2	Alternatives to Oxygen Activated Sludge	7-41
7.6.4.3	Conversion to BioACTIFLO® system.....	7-41
7.6.4.4	Screened Final Effluent	7-41
7.6.5	Summary of Secondary Treatment Alternatives.....	7-42
7.6.5.1	Modifications to Aeration Decks 1 & 2.....	7-42
7.6.5.2	Modifications to Aeration Decks 3 & 4.....	7-45
7.6.5.3	Screened Final Effluent (SFE) Treatment and Storage.....	7-45
7.6.5.4	Ongoing Asset Management	7-46
7.7	Disinfection	7-47
7.7.1	Introduction.....	7-47
7.7.2	Existing Conditions.....	7-48
7.7.3	Recent and Planned CIP Projects.....	7-48
7.7.4	Evaluation of Near-Term and Long-Term Upgrades to Disinfection	7-49
7.7.5	Summary of Disinfection Alternatives.....	7-49
7.7.5.1	Sodium Hypochlorite for Full Flow (Elimination of Gaseous Chlorine)	7-49
7.7.5.2	Alternative Disinfectants.....	7-51
7.8	Biosolids Processes.....	7-53
7.8.1	Introduction.....	7-53
7.8.2	Existing Conditions	7-53
7.8.2.1	Thickening.....	7-53
7.8.2.2	Sludge Storage	7-54
7.8.2.3	Dewatering.....	7-55
7.8.2.4	Incineration.....	7-56
7.8.2.5	Drying.....	7-56
7.8.2.6	Lime Addition/Stabilization	7-57
7.8.2.7	System Capacity and Operation	7-58
7.8.3	Historical Solids Production	7-59
7.8.4	Future Solids Production	7-60
7.8.5	Technology Identification and Screening.....	7-61
7.8.5.1	Project Drivers.....	7-61
7.8.5.2	Screening of Alternatives	7-62
7.8.6	Detailed Evaluation of Alternatives.....	7-64
7.8.6.1	Description of Alternatives	7-64
7.8.6.2	Cost Analysis.....	7-68
7.8.6.3	Quadruple Bottom Line Evaluation Criteria	7-68
7.8.7	Next Steps/Implementation Considerations	7-69

7.8.7.1	Advance Key Research & Innovation Projects.....	7-70
7.8.7.2	Future Study of Next Generation Biosolids Improvements.....	7-73
7.9	Summary of Planned Improvements and Budgetary Estimates.....	7-74
Section 8 Proposed Plan		8-1
8.1	Overview.....	8-1
8.2	GLWA CSO Controls.....	8-1
8.3	Major Phase 1 GLWA CSO Control Projects	8-12
8.3.1	In-System Storage Concept for Rouge River Outfalls	8-12
8.3.2	GLWA Member CSO Control Projects in Phase 1	8-15
8.3.3	Evaluation of GLWA CSO Operations Staffing.....	8-17
8.4	Major Phase 2 and 3 GLWA CSO Control Projects.....	8-17
8.4.1	General.....	8-17
8.4.2	Rouge River CSO Control Conduit.....	8-18
8.4.3	Phase 3 CSO Netting and In-Line Disinfection.....	8-24
8.5	Hub Utility Programs.....	8-24
8.5.1	Regional Operating Plan.....	8-24
8.5.2	Regional Wastewater Collection System Model.....	8-24
8.5.3	Regional Water Quality Monitoring	8-25
8.5.4	Collection System and MS4 Best Practices	8-28
8.5.5	Stream Debris and Obstruction Removal	8-31
8.5.5.1	Large Woody Debris Management in River Corridors.....	8-32
8.5.5.2	Potential Funding.....	8-34
8.5.6	Use of Metering and Modeling for Estimating CSO Volumes.....	8-35
8.5.6.1	Introduction.....	8-35
8.5.6.2	Case Studies	8-36
8.5.6.3	Digital Twin Technology for GLWA.....	8-39
8.6	Regional Collection System Improvements	8-40
Section 9 Implementation.....		9-1
9.1	Overview.....	9-1
9.2	Phased and Adaptive Implementation Strategy	9-2
9.3	Regionally Coordinated Regulatory Compliance Sequence.....	9-4
9.3.1	Implementation Pathways and GLWA Hub Utility Leadership	9-7
9.3.2	Coordination of Wayne County Rouge Valley Corrective Actions with CSO Control Programs for Redford Township, Dearborn Heights, and Inkster	9-7
9.4	Collection System and MS4 Best Practices Program.....	9-8
9.4.1	Pilot Study for Dry Weather Water Quality Improvement.....	9-9
9.5	Regional Operating Plan.....	9-10
9.6	Regional Water Quality Monitoring Program	9-10
9.7	Collaboration with Regional Transportation Plan and MDOT Highway Improvements	9-10
9.7.1	Regional Transportation Plan.....	9-10
9.7.2	Coordination with MDOT Projects in the Region	9-11
9.8	Using GSI as an Adaptive Management Strategy	9-14
9.8.1	Measurement of Effectiveness.....	9-14
9.8.2	Target Areas for GSI Implementation.....	9-15

9.8.3	Strategies for Vacant Lots.....	9-15
9.9	Five-Year Adaptive Management Assessments of Water Quality, System Performance and Resiliency	9-16
9.10	Annual Capital Improvement Planning.....	9-17
9.10.1	FY2021 Capital Improvement Program.....	9-17
9.10.2	DWSD Annual CIP.....	9-18
9.10.3	Wayne County Rouge Valley System Pipelines.....	9-18
9.10.4	Quick Wins.....	9-19
9.11	External Funding	9-20
9.12	Framework for Addressing Affordability.....	9-21
9.13	Communication Plan.....	9-22
9.14	Advanced Planning.....	9-23
9.14.1	Long Term CSO Control Plan	9-23
9.14.2	2021 SRF Project Plan	9-23
9.14.3	2028 Biosolids Plan.....	9-23
Section 10 Glossary, Acronyms and Definitions		10-1
Section 11 References		11-1

List of Tables

Table 2-1. Work Products of the Wastewater Master Plan.....	2-7
Table 3-1. Design Criteria of CSO Control Facilities.....	3-45
Table 3-2. Summary of Construction Expenditures for Control of Combined Sewer Overflow Control in the GLWA Regional Service Areas from 1990 to 2017.....	3-47
Table 3-3. History of Major Improvements at the WRRF.....	3-54
Table 4-1. Significant Events in Michigan.....	4-2
Table 4-2. NPDES GLWA Regional System - NPDES and CSO Summary.....	4-13
Table 4-3. Administrative Consent Order Summary.....	4-17
Table 4-4. GLWA LTCSO Plan of Record for Near East Side Detroit River.....	4-19
Table 4-5. GLWA LTCSO Plan of Record for Rouge River.....	4-19
Table 4-6. GLWA LTCSO Plan of Record for Upper Main Rouge River Outfalls.....	4-21
Table 4-7. Annual Wastewater Flows from Significant Industrial Users.....	4-23
Table 4-8. Current NPDES Permit Limits for WRRF Effluent.....	4-24
Table 5-1. Population Projections By First and Second Tier Member in 5-Year Intervals to Year 2060.....	5-7
Table 5-2. Projected Influent Flow at the GLWA Water Resource Recovery Facility.....	5-13
Table 5-3. Outfall Capacity based on River Elevation.....	5-19
Table 6-1. Categories of Technology for Combined Sewer Overflow Control.....	6-2
Table 6-2. Preliminary Identification of Alternatives for the Clinton River and Lake St Clair*.....	6-3
Table 6-3. Preliminary Identification of Alternatives for the Detroit River*.....	6-3
Table 6-4. Preliminary Identification of Alternatives for the Rouge River*.....	6-8
Table 6-5. Preliminary Identification of Alternatives for Multiple Water Bodies*.....	6-15
Table 6-6. GLWA/DWSD Outfall Root Cause Analysis.....	6-18
Table 6-7. Screening Criteria to Select Candidate Solutions for Modeling within Regional Alternatives.....	6-22
Table 6-8. Assignment of Candidate Solutions for Modeling in Regional Alternatives.....	6-23
Table 6-9. Attainment Measures.....	6-27
Table 6-10. Design Capacities Used for Calculating Percent of Capacity Utilized.....	6-29
Table 6-11. Decision Support Framework Scoring of Regional Alternatives.....	6-32
Table 6-12. Phasing of Proposed Projects.....	6-35
Table 6-13. Critical Elevations.....	6-38
Table 6-14. Analysis of Pumping Station Capacity for 10-year 1-hour and 10-year 24 hour Design Storms.....	6-44
Table 6-15. Interceptor Redundancy Requirements.....	6-45
Table 7-1. History of Major Improvements at the WRRF.....	7-4
Table 7-2. Projected Influent Flow.....	7-8
Table 7-3. Average Existing and Projected Raw1 Influent Load.....	7-8
Table 7-4. Summary of NPDES Permit Limits.....	7-9
Table 7-5. Desired Outcome and Performance Measures for WRRF.....	7-12
Table 7-6. Summary of Alternatives with the respective advantages and disadvantages.....	7-25
Table 7-7. Primary Clarifier Overflow Rate.....	7-32
Table 7-8. Ferric Chloride Dose and Volumes Required for Alternative Dosing Approaches.....	7-34
Table 7-9. Gravity Thickener Equipment Capacity Summary.....	7-54
Table 7-10. Sludge Storage Tank Details.....	7-54

Table 7-11. Dewatering Equipment and Capacity Summary.....	7-55
Table 7-12. Solids Disposal Unit Cost Summary	7-59
Table 7-13. Biosolids Production and End Use (2008 to 2018).....	7-59
Table 7-14. Comparison of Existing Versus Future Estimated Sludge Production	7-61
Table 7-15. Technologies that Passed Screening.....	7-62
Table 7-16. Proposed Process Train Configurations.....	7-64
Table 7-17. Summary of Estimated Capital Costs.....	7-68
Table 7-18. Current Energy, Research and Innovation Projects Related to Biosolids/Resource Recovery.....	7-71
Table 7-19. Summary of Liquid Treatment Train Improvements.....	7-74
Table 7-20. Estimated Expenditures thru 2013 for Active and Future Planned Projects WRRF Liquid Treatment Train.....	7-77
Table 7-21. Schedule of Active and Future Planned CIP Projects WRRF Liquid Treatment Train.....	7-79
Table 8-1. Proposed Plan for CSO Controls for the Rouge River.....	8-3
Table 8-2. Proposed Plan for CSO Controls for the Detroit River.....	8-6
Table 8-3. Estimated In-System Storage at New ISD Locations.....	8-14
Table 8-4. Proposed Overflow Structure Summary.....	8-21
Table 8-5. Preliminary Annual Self-Reporting Form: Inventory of Existing Collection System and Storm Sewers.....	8-29
Table 8-6. Preliminary Annual Self-Reporting Form: Practices for Capacity Management Operation and Maintenance.....	8-30
Table 8-7. Preliminary Annual Self-Reporting Form: New Facilities for Capacity Management peration and Maintenance.....	8-31
Table 8-8. Proposed Plan for Collection System Improvements.....	8-42
Table 9-1. Implementation Phases.....	9-3
Table 9-2. Regional Compliance Schedule by Phase.....	9-5
Table 9-3. Master Plan Coordination Activities with MDOT Projects.....	9-12
Table 9-4. Wayne County Wastewater Conduits Proposed for Transfer to GLWA.....	9-19
Table 9-5. Key Audiences, Messages and Tools for the Communication Plan.....	9-22

List of Figures

Figure 1-1. GLWA Adaptive Integrated Plan.....	1-29
Figure 3-1. GLWA Wastewater Service Area and Watershed Boundaries.....	3-4
Figure 3-2. GLWA Member Organization	3-5
Figure 3-3. Sewer Districts in the City of Detroit.....	3-7
Figure 3-4. GLWA First Tier Member Sewer Service Districts.....	3-8
Figure 3-5. GLWA Leased Sewers.....	3-9
Figure 3-6. MDOT Service Areas and Pump Stations	3-44
Figure 3-7. GLWA Wastewater Service Area Separated and Combined Systems.....	3-52
Figure 3-8. GLWA and Member CSO Control Facilities and Approximate Drainage Areas.....	3-53
Figure 3-9. GLWA Water Resource Recovery Facility, Existing Liquid Train PFD	3-62
Figure 3-10. GLWA Water Resource Recovery Facility, Existing Solids Train PFD	3-63
Figure 4-1. Four Monitoring Points for Final Effluent at the WRRF.....	4-24
Figure 5-1. GLWA First Tier Member Service Areas and Other Wastewater Service Providers.....	5-3

Figure 5-2. 1-Year 24-Hour Design Storm.....	5-14
Figure 5-3. 10-Year 24-Hour Design Storm.....	5-15
Figure 5-4. 25-Year 24-Hour Design Storm.....	5-16
Figure 5-5. Lake St Clair Water Surface Elevation Cycles (1900 through 2019).....	5-19
Figure 5-6. Comparison of the 10-year 1-hour Design Storm to Potential Mid-Century Average Change and Least Change Predictions.....	5-22
Figure 5-7. Comparison of the 10-year 24-hour Design Storm to Potential Mid-Century Average Change and Least Change Predictions.....	5-23
Figure 6-1. Cost and Benefit Curve for Regional Collection System Alternatives that Meet Michigan Water Quality Standards.....	6-34
Figure 6-2. Cost and Benefit Curve for Progressive Steps along the Integrated Adaptive Management Alternative to Meet Michigan Water Quality Standards.....	6-35
Figure 6-3. Water Level within 6 feet of Ground (10-year 1-hour Design Storm).....	6-43
Figure 6-4. GLWA Trunk Sewer and Interceptor PACP Ratings.....	6-45
Figure 6-5. Conceptual Alignments for Dry Weather Flow Redundancy.....	6-47
Figure 7-1. Historic Build-out of Existing WRRF.....	7-3
Figure 7-2. Existing Liquid Train Process Flow Diagram.....	7-6
Figure 7-3. Existing Solids Train Process Flow Diagram.....	7-7
Figure 7-4. Four Monitoring Points for Final Effluent at the WRRF.....	7-10
Figure 7-5. Flow Schematic of PS1 and Its Associated Headworks.....	7-16
Figure 7-6. Influent Sewers and Major Inter-process Conveyance.....	7-17
Figure 7-7. Schematic of PS2 and Its Associated Headworks.....	7-19
Figure 7-8. Preliminary Screening and Grit Treatment Layout PS2.....	7-29
Figure 7-9. Section View of Stacked Tray Grit Removal in Existing Grit Tanks.....	7-29
Figure 7-10. Recommended Improvements to Aeration Decks 1 and 2.....	7-43
Figure 7-11. Simple Schematic of Solids Handling.....	7-55
Figure 7-12. Capacity of Solids Handling System.....	7-58
Figure 7-13. Daily, 10-Day and 30-Day Moving Average of Thickened Sludge Production.....	7-60
Figure 8-1. Classification of CSO Frequency and Volume.....	8-2
Figure 8-2. Proposed New ISD Locations.....	8-13
Figure 8-3. Section Through Six Mile Relief CSO Outfall.....	8-14
Figure 8-4. Rouge River Suburbs.....	8-16
Figure 8-5. Rouge CSO Control Conduit -- North.....	8-19
Figure 8-6. Rouge CSO Control Conduit -- South.....	8-20
Figure 8-7. Typical Control Structure.....	8-22
Figure 8-8. Downstream Screen and Disinfection Facility.....	8-23
Figure 8-9. Typical Overflow Structure.....	8-23
Figure 8-10. Clinton River Water Quality Sampling Sites.....	8-26
Figure 8-11. Detroit River Water Quality Sampling Sites.....	8-27
Figure 8-12. Rouge River Water Quality Sampling Sites.....	8-28
Figure 8-14. GLWA Wastewater Master Plan Recommended Projects and Programs.....	8-44
Figure 9-1. Steps Along the Phased and Adaptive Implementation Pathway.....	9-2
Figure 9-2. The Adaptive Integrated Plan Leverages GLWA Hub Utility Leadership and Regional Partnerships.....	9-7

Wastewater Master Plan Report Sections

Technical Memoranda

- TM-1 West Side Model Integration
- TM-2 Planning Information
- TM-3 WRRF Models and Field Investigations
- TM-4A Regional Wastewater Collection System Model
- TM-4B Receiving Water Quality Model Development
- TM-4C Regional Collection System Alternatives Modeling
- TM-4D Regional Collection System Model Documentation
- TM-5A Water Resource Recovery Facility Liquid Treatment Processes
- TM-5B Water Resource Recovery Facility Sludge and Biosolids Processes
- TM-6A Collection System Long Term Strategy
- TM-6B Lake St. Clair Source Assessment Study
- TM-7 Cost Estimates and Financial Analysis
- TM-8 Flow Metering Program
- TM-9 WRRF Building Space and Site Evaluation

Regional Operating Plan

Optimization of Regional Operations

Section 1

Executive Summary

Historical Perspective

Since the Rouge River caught fire in 1969, and the subsequent enactment of the Clean Water Act in 1972, progressive investments and regional advocacy have spurred continual improvement in water quality protection. These improvements have been advanced by monitoring and modeling tools, pollution control technologies, wastewater infrastructure, habitat restoration, and environmental policies. The wastewater collection and treatment system improvements implemented over the last 50 years have profoundly advanced GLWA Member level of service, infrastructure sustainability, and regional water quality. Today the rivers and lakes of the region support increasing aquatic species diversity and expanding water recreation opportunities; important contributors to the growing Blue Economy in southeastern Michigan. Today, over 99 percent of the flow entering the GLWA system achieves NPDES permitted treatment standards each year.

Challenges Ahead

Although impressive improvements have been realized, there are significant challenges ahead.

Existing infrastructure requires continuous maintenance and asset management programs to ensure reliable performance and long-term sustainability. Persistent wet and dry weather pollution sources still contribute to water quality standard impairments. GLWA Member collection systems include 77 untreated CSOs, several SSOs, and an estimated 3,000 MS4 separate stormwater outfalls that contribute to water quality impairments during wet weather.

The region's waterways are influenced by development trends experienced over the past 50 years that changed the landscape and extent of the service area. Since 1970, when Detroit's population peaked, the GLWA service area quadrupled in size to 944 square miles as the population moved from urban to suburban areas. The total population of southeast Michigan stayed approximately the same, but suburban development exploded. Rural and agricultural land uses were transformed into residential, commercial, and industrial uses, resulting in vastly expanded wastewater collection systems to serve population shifts and increased stormwater runoff from impervious areas. For example, constructed and reconstructed roadways now contribute one-third of the stormwater runoff in the combined sewer service area. More recently green stormwater infrastructure

The Detroit River and its Connected Waterways Spawned and Sustain Economic Vitality

The Detroit River prompted early development of the City of Detroit because it provided a sustainable drinking water supply and a vast shipping and commerce route connecting ports along lakes Superior, Michigan and Huron to Lake Erie. As the City and suburbs developed, the river increasingly supported new recreational and aquatic life uses, including Belle Isle Park, the International Fish and Wildlife Refuge, the River Walk, marinas and yacht clubs, cruise ships and most recently plans for the Ralph C. Wilson, Jr. Centennial Park. Proximity to clean and abundant water resources bolsters the region's economic prosperity.

management practices have trended upwards to counter the explosive growth of impervious area as contemporary development ordinances are applied. This expansion of the service area added to the challenge and cost of managing capacity, maintaining infrastructure, and investing in the new infrastructure needed to achieve water quality protection goals.

The changes experienced in metropolitan Detroit and southeast Michigan over the past 50 years generally mirror those experienced in other major urban areas across the country. Many metropolitan sewer and drainage districts face the same challenges with combined and sanitary sewer overflow control, flooding, storm water management, wastewater treatment, and biosolids disposal. Oftentimes these challenges are compounded by broad income disparities across a region, which poses affordability concerns as competing demands vie for limited financial resources. In southeastern Michigan current wastewater service charges already impose a high financial burden on some residents. The major challenge of this Master Plan is to identify a plan that is affordable to all, while addressing the region's wastewater service and source water protection needs for the next 40 years. This Master Plan applies tested national strategies for each area of practice, including regionally integrated planning principles which focus on ensuring that dollars are expended wisely over time by prioritizing projects that produce the most environmental benefits for the least cost using an adaptive framework that produces progressive improvements while managing affordability.

Lake St. Clair is a Cherished Recreational Resource

The lake provides residents and visitors with diverse recreational opportunities including swimming, boating, fishing, picnicking, and other aesthetic interests.

At the same time, it is the most environmentally sensitive receiving water in the GLWA service area. It's a relatively shallow lake for its size, which makes it more vulnerable to pollutant loadings that cause beach closures and diminish summertime recreational experiences.

The Clinton River Watershed Enhances Quality of Life

The Clinton River is a major tributary to Lake St. Clair and provides its own recreational interests to the 1.4 million people living within the watershed. The river supports community and recreational interests such as fishing, canoeing, picnicking, and hiking/biking trails. While Clinton River water quality is generally better than the Rouge River, dry and wet weather sources still impair attainment of water quality goals for the river and lake.

Plan for the Future

While many geographies around the world lack the freshwater resources needed to promote and sustain economic growth and quality of life goals, southeastern Michigan enjoys an abundance of freshwater, unmatched across the globe. Source water protection investments are critical to the future well-being and economic vitality of the region, as local waterways provide for the region's drinking water supply and support diverse recreational and commercial interests that enhance quality of life and economic prosperity. This Master Plan appreciates that the region's waters are *Ours to Protect*, builds on the achievements of the last 50 years, and identifies a path forward that manages affordability by leveraging regional optimization and partnership opportunities.

Shared Desired Outcomes

In acknowledging the size and complexity of the GLWA service area, which is served by multiple Member Partners and Tier 2 customers, and the complexity of the technological, operational, and financial challenges ahead, this master plan takes a holistic and regionally integrated planning approach to CSO, SSO, wastewater treatment, stormwater, capacity management, and receiving water quality with the goal of leveraging the power of regional collaboration. To this end, this GLWA Wastewater Master Plan was developed through intensive regional collaboration with GLWA Member Partners, EGLE, and many other stakeholders.

The Plan for the Future Will Tap the Rouge River's Potential

The Rouge River greatly influenced the development history of metropolitan Detroit. Urbanization of the river's natural floodplain has led to pollution from various sources, flooding, high streamflow variability and habitat degradation. The Rouge River is one of 43 Areas of Concern within the Great Lakes watershed.

Starting in 1992, Wayne County led the Rouge River restoration initiative through the support of the USEPA Rouge River National Wet Weather Demonstration Project funding. This effort, along with collaborative work by the Detroit Water and Sewerage Department provides a firm foundation for the next generation of water quality protection for the Rouge River. Planned improvements will tap the Rouge River's potential to support recreation and contribute to the economic prosperity of the watershed.

The Plan for the Future Includes Protections for Lake Erie

Although Lake Erie is not a direct receiving water for the GLWA service area, this downstream Great Lake ultimately receives some pollutant loadings from GLWA and Member Partner wastewater and drainage district discharges. This Master Plan appreciates that waterways are not constrained by jurisdictional boundaries and that downstream waterbodies should be considered in developing sustainable long-term strategies for the region.

The Plan is guided by 5 desired outcomes, as shown on the right, that reflect the environmental values of GLWA, its Member Partners, and State of Michigan 21st Century Infrastructure Report. These shared outcomes are grounded in a firm regional commitment to maintain reliable high-quality wastewater services, which requires intensive focus on asset management programs that monitor and prioritize investments in existing infrastructure. Cost optimized regional investment in existing and new infrastructure will drive achievement of the five shared outcomes as summarized in the Table below.



Desired Outcomes of the Wastewater Master Plan

Outcome	How the Plan Will Achieve the Outcome
Protect Public Health and Safety	<ul style="list-style-type: none"> ✓ Establishes regional critical HGL and control strategies to reduce the risk of basement flooding and sanitary sewer overflows ✓ Protects property from flooding ✓ Provide adequate disinfection of discharges ✓ Reduce air emissions
Preserve Natural Resources and a Healthy Environment	<ul style="list-style-type: none"> ✓ First flush capture to meet dissolved oxygen standards on the Rouge River ✓ Separating stormwater; coordinate sewer and transportation ✓ Promote Green Infrastructure ✓ Reduce chemical and power use ✓ Reduce phosphorus load to receiving waters
Maintain Reliable, High Quality Service	<ul style="list-style-type: none"> ✓ Continued investment in the asset management program ✓ Regional real time control; dashboards ✓ Demonstrated ROI of capital expenditures
Assure Value of Investment	<ul style="list-style-type: none"> ✓ Making the most of existing infrastructure ✓ Collaboration with MDOT in highway and sewer system planning ✓ Regional Operations Plan and agreements
Contribute to Economic Prosperity	<ul style="list-style-type: none"> ✓ High quality service sustains rate base that can reinvest ✓ Capacity for economic expansion; public education ✓ Clean water and abundant recreation create economic vibrancy ✓ Improved collaboration with industry in service area ✓ Keep water and sewer rates competitive to entice new industry and maintain existing industry

Regional Collaboration Leads to Adaptive Integrated Plan

Since there are many optional pathways to achieving water quality standards and other shared outcomes, a series of local and regional alternatives were evaluated to determine the most cost-effective recommendations for this master plan. On a regional basis, the alternatives include:

1. The 2008 Long Term CSO Control Plan and its 2010 Supplement, known as the Plan of Record
2. Complete Sewer Separation
3. Optimize the treatment capacity of the Water Resource Recovery Facility (WRRF)
4. Maximize the use of green stormwater infrastructure
5. An integrated planning approach that is adapted over time based on measuring the water quality progress of a series of progressive implementation steps

The evaluation of these alternatives showed that an integrated planning approach that is adapted over time is the most cost-effective way to meet the 5 desired outcomes. The proposed plan, known as the Adaptive Integrated Plan, will be implemented in a series of steps as illustrated in the figure below.

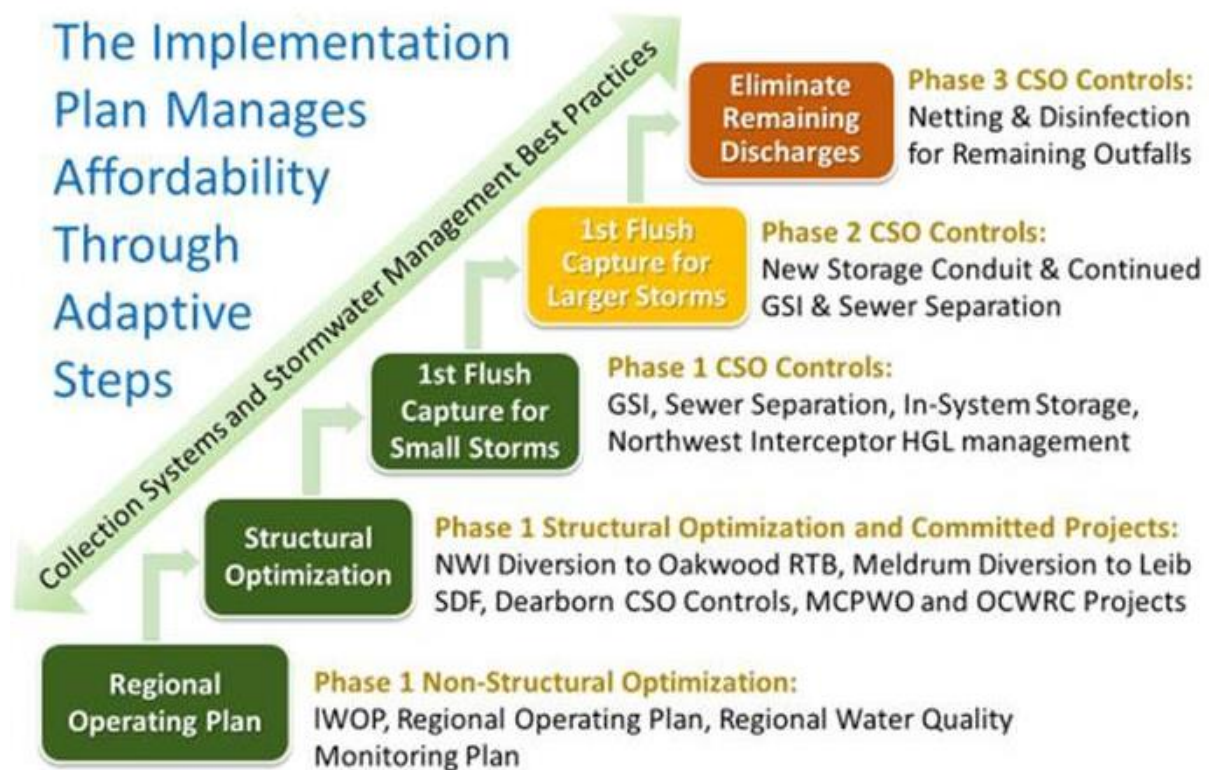

The long-term solution includes progressive improvements to the WRRF and the regional collection system with priority focused on maximizing the use of existing infrastructure first. Significant emphasis is placed on improvements and optimization of existing assets, so that optimal performance is achieved with existing infrastructure before building new facilities. This adaptive approach includes optimizing the operation of the regional collection system via a Regional Operating Plan (ROP) developed by GLWA and its Members. The ROP will use the findings of a new

computer model of the regional collection system to implement a new set of operating protocols for the GLWA service area.

Also, a new Regional Water Quality Monitoring Program is proposed to collect continuous real time data on water quality in the Rouge, Clinton and Detroit Rivers and Lake St Clair. The data collected from the Regional Water Quality Monitoring Program will be used to guide efforts by GLWA and its Members in ongoing inspections, maintenance, capacity management and rehabilitation of combined sewers, separated sanitary sewers, and separate storm drainage systems.

Regional collaboration and alignment is critical to the success of the Adaptive Integrated Plan, as the cost efficiencies identified in the plan rely on synergistic partnerships; including GLWA, Member Partners, EGLE, MDOT, City Planning, watershed groups, developers, and others across the region. GLWA is committed to serve as a hub utility for the region, providing the leadership and integration necessary to realize the power of multiple regional partnerships.

Regional Collaboration is Critical to the Success of the Adaptive Integrated Plan

Implementation of the proposed Adaptive Integrated Plan will require coordinated and aligned actions by GLWA, its Member Partners, county health departments, Michigan DOT, Michigan EGLE, developers, and environmental, recreational, and green infrastructure advocacy groups.

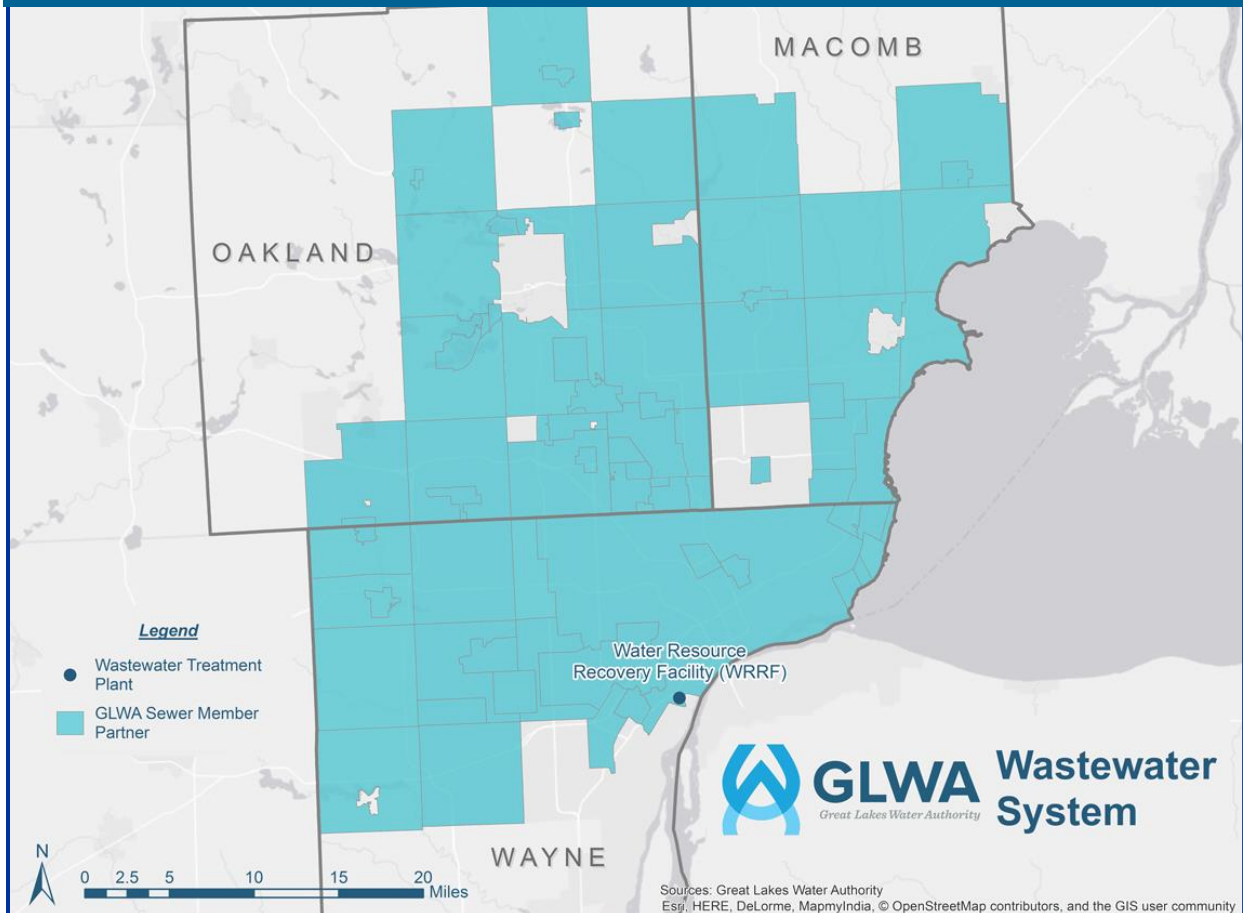

The plan establishes three major phases of improvements using a cost optimized sequencing of integrated planning activities and projects as shown at right. Each phase is designed to build upon one another and produce incremental water quality and level of service benefits using adaptive management principles that inform future phases, manage cost impacts, and converge on achieving all desired outcomes.

Major Recommendations of the Wastewater Master Plan

The major recommendations of the Wastewater Master Plan are described below for the following implementation areas:

- Collection System and Storm Sewer Best Practices
- Regional Water Quality Monitoring Program
- Regional Operating Plan
- Water Resource Recovery Facility
- Regional Collection System Rehabilitation and Asset Management
- Green Infrastructure and Sewer Separation
- Clinton River and Lake St Clair Water Quality
- Rouge River Water Quality
- Detroit River Water Quality
- Implementation Summary

The Adaptive Integrated Plan Will Progressively Produce Enhanced Benefits Through Three Phases

Phase 1 – OPTIMIZE Use of Existing Facilities and Integrated Planning

- *Reduce public health risks with additional in-system storage for small storms and optimized conveyance capacity.*
- *Achieve the Michigan Water Quality Standards for partial body contact and aquatic species protection (dissolved oxygen) in dry weather.*

Phase 2 – ADAPT and Expand Facilities Based on Phase 1 Progress

- *Expand public health protections with additional in-system storage, sewer separation, and conveyance optimization.*
- *Achieve the Michigan Water Quality Standards for full body contact in dry weather and dissolved oxygen in wet weather.*

Phase 3 – SUSTAIN System Performance to Achieve All Desired Outcomes

- *Continue advancing system optimization and infrastructure maintenance programs as technologies improve*
- *Implement any remaining controls necessary to achieve full compliance with Michigan Water Quality Standards*

Collection System and Storm Sewer Best Practices

Why Is This Important?

Receiving water quality is impacted by the performance of the regional pipeline network and the treatment facilities. Three quarters of the GLWA regional collection system and tributary Member Partner systems consists of separate sanitary sewers and storm drains. There are an estimated 3,000 separate stormwater outfalls, 77 untreated CSOs, and 30 treated CSO discharges. All outfalls reach the waterways of the service area and impact water quality. The estimated length of public and private pipelines connected to the WRRF exceeds 24,000 miles, enough to circle the globe. Given the size and complexity of the regional pipeline network, and its impact on water quality and capacity optimization, programs are proposed for capacity management in the sewer system and water quality control from separate storm drainage outfalls.

CMOM/MS4 and 5 OUTCOMES	
Outcome	How Will CMOM/MS4 Help?
Protect Public Health and Safety	<ul style="list-style-type: none"> • Manage available capacity to minimize risk of system back-ups and overflows
Preserve Natural Resources and a Healthy Environment	<ul style="list-style-type: none"> • Reduce untreated sewer overflows
Maintain Reliable, High Quality Service	<ul style="list-style-type: none"> • Allocate appropriate level of inspection, repair and operation • Reduce risk of system failures
Assure Value of Investment	<ul style="list-style-type: none"> • Extend service life and optimize value to adapting conditions
Contribute to Economic Prosperity	<ul style="list-style-type: none"> • Enhance property values through improved operations and water quality

What Will Be Done?

First, GLWA will lead a voluntary program for its Members to document their efforts in maintaining and managing their collection systems. The information collected in this effort will be useful for each Member in demonstrating system performance for regulatory purpose and for responding to basement back up claims. This program will apply to both separate sanitary sewer systems and combined sewer systems.

Second, GLWA will improve its processes to manage the capacity and flows within its system. Capacity limits for Members have been established based on a variety of criteria since 1940 when the regional system began operation. Today, the regional collection system runs full, pipes will overflow, and wet weather facilities will start to operate when there is moderate rainfall across the service area. Therefore, when Members seek additional capacity, there is a cost to the regional system to accommodate the new flow.

Third, separated storm sewer systems that drain directly to rivers and lakes and are not within the jurisdictional authority of GLWA. However, the quality of the stormwater from these systems impacts rivers and lakes. In order to achieve water quality standards, the quality of storm water must be managed concurrently with the construction of new CSO control facilities. Today, three quarters of the regional service area is served by separate storm sewers. More separation is recommended in this plan in conjunction with major highway improvements and where combined sewers can be cost-effectively separated. Stormwater quality will be managed with the implementation of best management practices established in Municipal Separate Storm Sewer Systems (MS4) permits.

How Will It Be Implemented?

1. A process for voluntary annual reporting is being developed for GLWA Members to report on their Capacity Management, Operation and Maintenance (CMOM) activities and MS4 activities. A preliminary form has been developed with input from the Steering Team, and the form is consistent with potential future requirements from the Michigan Department of Environment, Great Lakes, and Energy (EGLE). The first reporting period is anticipated to be July 1, 2020 to June 30, 2021.
2. Results of the annual surveys will be compared with annual reports from the Regional Operating Plan and the Regional Water Quality Monitoring Program when necessary to investigate the source of water quality impacts.
3. A pilot program will be developed to establish a series of measures to improve the attainment of MS4 program objectives. It is believed that an increase in funding is needed to manage stormwater quality. The pilot program will identify the most cost-effective means to phase-in the implementation of new storm water management practices.
4. The GLWA Outreach program offers work group and informational meeting venues for GLWA to collaboratively partner with its Members to develop solutions to utility issues and challenges. The Collection System Best Practices and Separated Storm Sewer System program is largely implemented by GLWA Members. Therefore, this program should be guided by an Outreach work group to assure effective Member knowledge and input is provided.

Regional Water Quality Monitoring Program

Why Is This Important?

Current and accurate data on water quality in the Rouge River, Clinton River, Lake St Clair and Detroit River is the principle way to monitor the suitability of these waters for their designated uses of recreation and aquatic life protection. Water quality monitoring identifies areas of impairment to focus corrective action and measures progress from actions. Receiving water quality in the service area has been monitored by a number of agencies in the past. These monitoring efforts include long term data collected by USGS, special studies by watershed groups, sampling for MS4 programs, studies by EGLE, seasonal reporting on public swimming areas, and in the 1990's and early 2000's by the US EPA and Wayne County Rouge River Program. Currently, there are 6 continuous monitoring sites operated by USGS and periodic efforts by others, but there is no regular comprehensive review and assessment of the data and analysis of water quality trends.

What Will Be Done?

The proposed Regional Water Quality Monitoring Program (RWQM) provides continuous monitoring of water quality parameters essential to protection of public health and aquatic life from pollutants associated with untreated sanitary sewage and separated storm water. The RWQM Program has been developed with 22 continuous monitoring stations around GLWA's regional wastewater service area. The monitoring stations will collect data on temperature, pH, flow, dissolved oxygen, total suspended solids, biochemical oxygen demand, *E. coli*, nitrogen, and

REGIONAL WATER QUALITY MONITORING PROGRAM and 5 OUTCOMES	
Outcome	How will the RWQM Program Help?
Protect Public Health and Safety	<ul style="list-style-type: none"> Enhanced reporting on suitability of waters for recreational activities; Improved implementation of corrective actions through 'first responder' notifications of areas with high bacteria counts
Preserve Natural Resources and a Healthy Environment	<ul style="list-style-type: none"> Improved implementation of corrective actions through 'first responder' notifications of areas with low dissolved oxygen; Enhanced documentation of progress and trends
Maintain Reliable, High Quality Service	<ul style="list-style-type: none"> Relates level of service to receiving water quality conditions and tangible benefits
Assure Value of Investment	<ul style="list-style-type: none"> Reporting of water quality conditions connects visible benefits to investments
Contribute to Economic Prosperity	<ul style="list-style-type: none"> Improved water quality enhances quality of life, property values, and tourism revenues

phosphorus. Data from beach sampling and other short-term programs by watershed groups will also be obtained.

GLWA will collect all data and provide multiple levels of action. Persistently high levels of bacteria or low dissolved oxygen will require an initial action by GLWA's Field Services Group to identify specific sections waterway or pipelines that require inspection. GLWA will engage assistance from the Member whose system appears to be contributing to the problem. RWQM data will also be used for quarterly and annual reporting, and 5-year assessments of progress and next priorities. The annual reports and 5-year assessments will provide a comprehensive view of the combined benefits of CMOM, MS4, and CSO control in each waterway. As technology improves with instantaneous measurements, real time data reporting to an on-line subscribe network would be feasible.

How Will It Be Implemented?

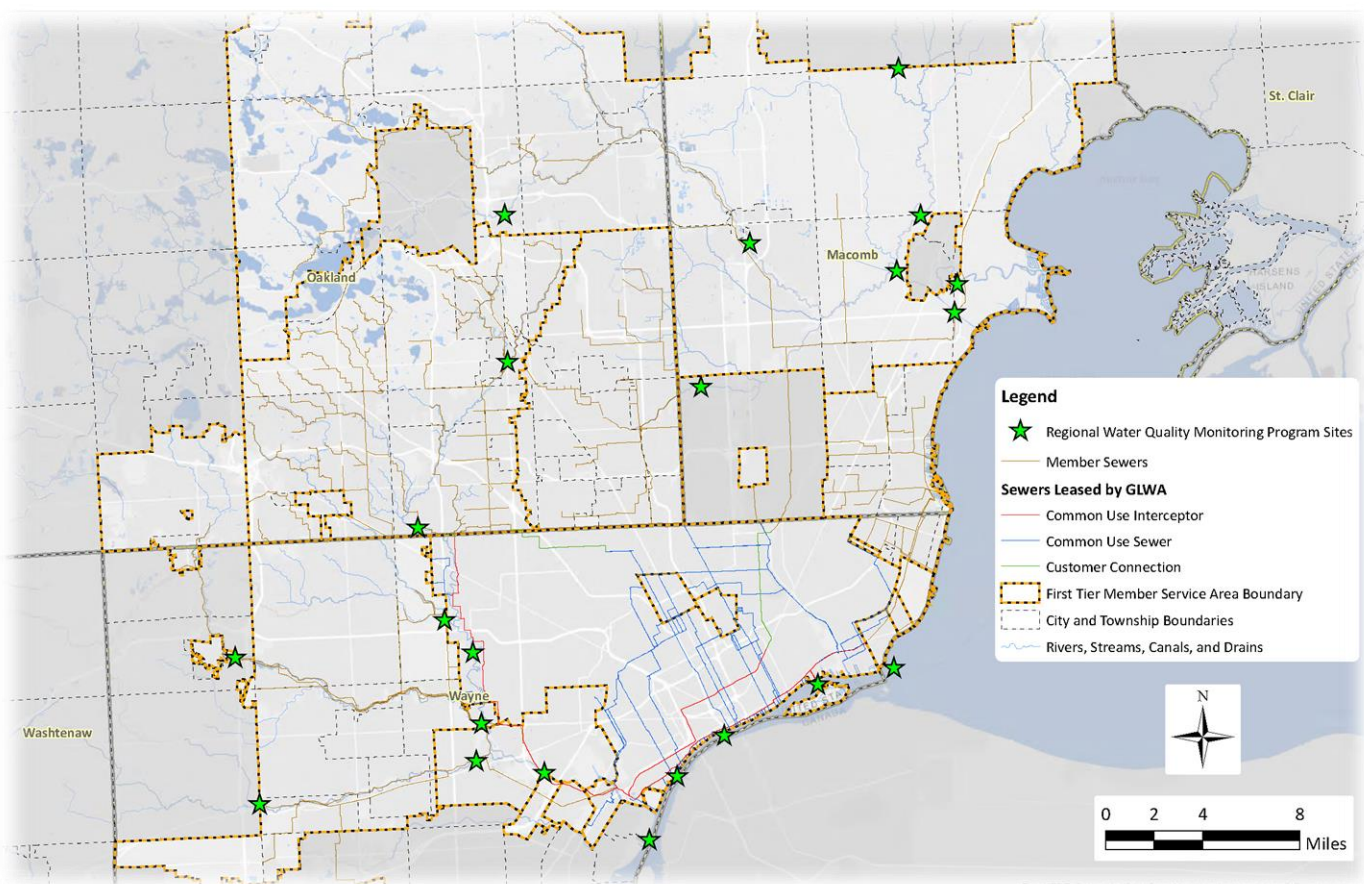

Water Quality Monitoring and Modeling Will Provide Measures for Success

A network of water quality monitoring stations will be established along water ways of the GLWA wastewater service area. These stations will include existing USGS monitoring sites, reactivated historic monitoring sites and new sites. In addition, data from beach sampling collected by county agencies will be regularly updated. A regional data management and reporting system is planned.

1. The RWQM will be implemented in 2 or more stages. The first stage is proposed to include approximately 12 continuous sampling locations around the region, including the existing sites.
2. Partnering with USGS to operate and maintain the sampling stations is an option that will be evaluated for implementation.
3. Stage 1 will include the development of the data management system to collect data from each continuous site and from seasonal and short-term sampling programs conducted by other agencies and watershed groups. Stage 1 will also include the development of standard reports and annual assessment procedures.
4. Stage 2 and 3 will expand the network to the proposed 22 continuous sampling locations. It is anticipated that the full water quality monitoring network will be implemented within Phase 1 of the planning period.

Regional Operating Plan

Why Is This Important?

GLWA has a newly approved 2019 Interim Wet Weather Operating Plan (IWOP) that optimizes the use of 183 miles of regional pipelines, the WRRF, remote pumping and CSO treatment facilities located in Detroit. The Regional Operating Plan (ROP) builds on the IWOP and extends it to operation of other Member collection systems. The ROP provides a means for Members to collaboratively act with GLWA – before, during and after a storm event -- to optimize wet weather performance of the regional system.

What Will Be Done?

The ROP facilitates collaboration between Member and GLWA operators to maximize flow to the WRRF and correspondingly minimize system overflows and back-ups during storm events. An important new tool is the ‘Real Time Control Dashboard’, which is a computer screen that shows Member operators the flows and water surface elevations in the regional system downstream of the Member’s connection. The ‘Real Time Control Dashboard’ tells the Member operators when flow can be released within the contract limit, and when there is capacity for a higher flow from the Member. These dashboards will be implemented and tested over the first three years of the planning period.

Another feature of the ROP is a protocol for dewatering retention treatment basins (RTBs) following a storm event. A storm event of 2-inches or more across the service area will fill all RTBs and in-system storage totaling over 500 million gallons. This stored volume is equal to a full day of dry weather flow at the WRRF. The protocol for dewatering uses the ‘Real Time Control Dashboard’ and other rules to dewater stored volume as quickly as feasible, while maximizing flows receiving secondary treatment at the WRRF and minimizing overflows.

A third feature of the ROP is the establishment of a series of critical hydraulic grade elevations within the regional collection system. These critical hydraulic grade elevations were established in consultation with GLWA Members based on maximum water surfaces to avoid the risk of system back-ups and sanitary sewer overflows. The ROP includes the installation of additional level sensors for monitoring the critical hydraulic grade elevations at each Member’s metered connection and at several areas in the DWSD system that have historically been at risk of flooding.

REGIONAL OPERATING PLAN and 5 OUTCOMES	
Outcome	How will the ROP Help?
Protect Public Health and Safety	<ul style="list-style-type: none"> • Manage available capacity to minimize risk of system back-ups and overflows
Preserve Natural Resources and a Healthy Environment	<ul style="list-style-type: none"> • Minimize untreated overflows and manages dewatering to maximize secondary treatment
Maintain Reliable, High Quality Service	<ul style="list-style-type: none"> • Collaboration in operation, continued learning by event reviews
Assure Value of Investment	<ul style="list-style-type: none"> • Real time control maximizes the value of existing assets by optimizing performance during changing conditions
Contribute to Economic Prosperity	<ul style="list-style-type: none"> • Maximizes water quality protection for each event

How Will It Be Implemented?

1. The ROP will be performed through the Wastewater Best Practices Work Group (BPWG). The BPWG currently has responsibilities for reporting and management of total chlorine residual as prescribed in the GLWA NPDES permit. Responsibilities of the BPWG will be broadened to include pre-event planning, post-event analysis, and annual reporting.
2. Goals for the ROP will be developed for 3-year periods. The goals for the first 3-years include organization, training and development of standard reports. Standard reports from the ROP will provide tracking of GLWA and Member efforts to reduce untreated CSO discharges, maximize wet weather flow to the WRRF and maximize secondary treatment capacity during storm events.
3. The ROP will be an extension of GLWA's IWOP. In the first 5-years of the ROP, the IWOP recommended regulator modifications along the DRI will be implemented and piloting of proposed pump operations at PS1 and PS2 will be performed.

KEY FEATURES OF THE REGIONAL OPERATING PLAN

- *Critical hydraulic grade lines elevations established at Member connection points and other control locations*
- *Member dashboards provide real time information on regional operations*
- *Regional plan to manage RTB dewater flows following the end of storm events*
- *Coordinated pre-storm planning by GLWA and Members for forecasted events greater than 1.5 inches*
- *Post-storm performance reviews based on the use of the new regional SWMM Model as a "digital twin" of the SCADA system*

Water Resource Recovery Facility

Why Is This Important?

The GLWA Water Resource Recovery Facility (WRRF) is one of the largest wastewater treatment plants in the world with the capacity to treat up to 1,700 million gallons per day (mgd) through primary treatment and 930 mgd through secondary treatment. Major parts of the facility are 80 years old. Influent pumping, preliminary and primary treatment facilities went on-line in 1940, sludge incineration in 1950, and secondary treatment in 1970's at the advent of the Clean Water Act. The facility was expanded in the 1990s to treat flow from the Northern Interceptor–East Arm, with the construction of Pumping Station 2 and associated preliminary treatment, and optimized for wet weather flow in early 2000's. The new biosolids drying facility, which produces a beneficial product went on-line in 2016, allowing the decommissioning of the Complex I incinerators. Disinfection of primary effluent was implemented in 2019. Sufficient dry weather flow capacity exists with the current infrastructure for projected growth over the 40-year planning period. The facility does a good job meeting effluent standards, however, moving forward, investments are required to keep the aging facility in good working order, to provide more efficient and cost-effective treatment, and in some cases, transformative projects to move the facility to a “Utility of the Future”.

WATER RESOURCE RECOVERY FACILITY and 5 OUTCOMES	
Outcome	How does an Improved WRRF Help?
Protect Public Health and Safety	<ul style="list-style-type: none"> • Continue to meet NPDES effluent limits; • Transition from chlorine gas and sulfur dioxide for disinfection and dechlorination • Reduce air emissions.
Preserve Natural Resources and a Healthy Environment	<ul style="list-style-type: none"> • Maximize flow to secondary treatment • Optimize secondary treatment to reduce oxygen and chemical use through implementation of biological phosphorus removal • Reduce phosphorus loading to Lake Erie • Position for potentially lower effluent limits in the future • Encourage water reuse
Maintain Reliable, High Quality Service	<ul style="list-style-type: none"> • Pump reliability improvements • Robust asset management program
Assure Value of Investment	<ul style="list-style-type: none"> • Improved grit and screenings removal and extend life of down-stream equipment • Reduce unit cost to treat influent flows and loads
Contribute to Economic Prosperity	<ul style="list-style-type: none"> • Stabilize rates through energy efficiency and recovery, power generation, and water reuse • Public education and training for job opportunities • Cooperation with local industry.

What Will Be Done?

Goals for the WRRF over the next 40 years include: improve reliability of pumping, improve screenings and grit removal and handling, optimize secondary treatment system, and transition from chlorine gas for disinfection to safer chemicals or methods. In addition, an implementation plan for the next generation of biosolids management will be developed for the period following 2035 when Complex II incinerators will need renewal and the existing contract operations for BDF will end. Future biosolids will be studied further closer to the implementation date. Current analysis shows that the two most feasible long-term options are expansion of the biosolids drying facility, or implementation of anaerobic digestion with thermal hydrolysis for energy recovery. The anaerobic digestion alternative would significantly reduce the volume of biosolids for drying and improve the BDF product. Studies for the Wastewater Master Plan show that there are additional markets for Class A pelletized biosolids that can supplement current contracts for land application.

The Plan for the Future Includes Nutrient Loading Protection for Lake Erie

Controlling the nutrient load from the Detroit River to Lake Erie is an international water quality priority.

GLWA and other agencies in the United States and Canada have important roles in reducing phosphorus loads from the WRRF and combined sewer overflows.

How Will It Be Implemented?

Due to the age and size of the WRRF, there are typically over two dozen capital improvement projects underway at different locations at the facility. GLWA manages the sequence and timing of these projects carefully so that individual projects can be performed independently within clearly defined scopes of work without adversely impacting permitted capacity. The new capital improvement projects recommended through the Wastewater Master Plan have been planned to integrate with other projects that are being completed. A general sequence of projects has been recommended with the following priorities:

1. Asset management to replace and repair in-kind those components of the WRRF that are designated to remain and have reached their useful life.
2. High return on investment project that can be completed early in the planning period and then yield annual operating cost savings.
3. New function and transformative projects that advance GLWA's capabilities in wastewater treatment, resource recovery, and operational efficiency.

Regional Collection System Rehabilitation and Asset Management

Why Is This Important?

GLWA operates 183 miles of trunk sewers and interceptors that convey wastewater from Member's collection systems to the WRRF and wet weather flow treatment facilities. Over the past twenty years, GLWA and DWSD have worked with Members to reduce and right-size the regional system to place pipelines into the control and ownership of the Members who singularly use the pipes. The GLWA regional collection system receives flow from approximately 3,400 miles of sewer owned by DWSD and an additional 10,800 miles owned by other Members.

REGIONAL COLLECTION SYSTEM and 5 OUTCOMES	
Outcome	How will Improvements to the Regional Collection System Help?
Protect Public Health and Safety	<ul style="list-style-type: none"> • Maintain structural integrity and service life to support the ROP
Preserve Natural Resources and a Healthy Environment	<ul style="list-style-type: none"> • Prevent river inflows that contribute to combined sewer overflows.
Maintain Reliable, High Quality Service	<ul style="list-style-type: none"> • Create additional pipeline redundancy or emergency situations and scheduled inspection and rehabilitation
Assure Value of Investment	<ul style="list-style-type: none"> • Program for scheduled inspections, replacement and rehabilitation.
Contribute to Economic Prosperity	<ul style="list-style-type: none"> • Structural integrity and redundancy of assures that pipelines are lifelines to sustain the regional economy

What Will Be Done?

Long term planning for the regional collection system has goals for inspection, rehabilitation, river inflow monitoring and control, increased redundancy, and reduction in the number of pump stations. Another goal is to improve the accuracy and currency of data on the location, condition, and connections to Member systems.

GLWA leases and operates most of the trunk and interceptor sewers that convey Member wastewater flow to the WRRF. However, there are two locations where the regional conveyance system includes pipelines owned and maintained as Wayne County Drains. These locations include a 500-foot section of the Northwest Interceptor in Dearborn Heights near Ford Road and a 2,000-foot section of the Fox Creek Enclosure in the Grosse Pointes. These two pipelines are critical for conveyance of wastewater and control of combined sewer overflows. This Master Plan includes an update to legal agreements to assure that these pipelines continue to perform to the level of service requirements.

How Will It Be Implemented?

1. Completion of projects to rehabilitate portions of existing trunk sewers and interceptors (CON-149 and DB-226)

2. A second complete pipeline inspection prior to 2022
3. Review results of recent inspection efforts and develop protocols for visual, CCTV, sonar and laser inspection techniques.
4. Following completion of CON-149, develop a list of priorities for sewer rehabilitation based on the assessments performed in the Wastewater Master Plan. Priorities have tentatively been assigned based on probability of failure and consequence of failure.
5. Establish a contract size for pipeline and outfall rehabilitation projects that considers contractor bonding capacity, cost-effectiveness, and performance management. It is anticipated that 3-year programs for \$30 million to \$50 million covering multiple reaches of priority sewers for detailed inspection and rehabilitation work would be provide GLWA with competitive bids and performance management,
6. Proceed with current projects for rehabilitation of the Fairview, Conner and Freud Pumping Stations. These projects will extend the service life and reliability of these facilities to the year 2040.
7. In 2030, review results of pipeline and pump station rehabilitation costs and re-evaluate the concepts and timeline for dry weather flow interceptor redundancy recommended in this Master Plan.

***The Adaptive Integrated Plan
Can Evolve with Uncertainties
Like Climate Change***

The water level in the Detroit River rises and falls in cycles with the level of the Great Lakes. It is possible that these cycles will be influenced by climate change. In 2019, the Detroit River reached a new record level at approximately the 100-year flood stage during July 2019. The high river level can reduce the volume of combined sewer overflows, but it can also add river inflow to the collection system and consume valuable conveyance and treatment capacity.

Green Stormwater Infrastructure and Sewer Separation

Why Is This Important?

Green stormwater infrastructure (GSI) and sewer separation are examples of source reduction sewer overflow control solutions that prevent stormwater inflow from entering the combined sewer system. GSI solutions collect, infiltrate, evaporate, transpire, and store stormwater runoff for slow release back to the combined sewer system after a storm. Sewer separation routes stormwater inflow through separate storm drains for discharge to a waterway, including application of stormwater best management practices to protect water quality. GSI and sewer separation provide long term solutions to reduce CSO volume, improve water quality, manage streamflow variability, re-charge groundwater, restore natural hydrologic features, and create wildlife habitat. These combined benefits can improve quality of life, property values, and provide amenities to communities in the form of environmentally tailored streetscapes, stormwater management ponds, park land and wetlands.

What Will Be Done?

Implementation of GSI requires zoning rights or ownership rights to land. GLWA has jurisdictional responsibility for wastewater collection and treatment, and therefore controls relatively little land in its regional service area. Members and Member Partners of GLWA have municipal jurisdiction for most of land and public rights of way in the service area, MDOT and County highway departments control major rights of way, and residents, businesses and institutions own private properties. Therefore, GLWA's role in implementation of GSI and sewer separation

GREEN INFRASTRUCTURE AND SEWER SEPARATION	
Outcome	How will GSI and Sewer Separation Help?
Preserve Natural Resources and a Healthy Environment	Recharges groundwater, reduces stream flow variability, creates wildlife habitat, treats stormwater, reduces combined sewer overflows.
Assure Value of Investment	Removes wet weather flows from the combined sewer system to reduce the cost of conveyance and treatment
Contribute to Economic Prosperity	GSI streetscapes, stormwater management ponds can be used with neighborhood designs to improve property values in communities

GSI Brings Multiple Co-Benefits that Contribute to Economic Prosperity

GSI and sewer separation help optimize costs and improve water quality. By preventing rainfall from entering the sewer system and protecting water quality with best management practices, the cost of transporting stormwater for miles through regional pipes is reduced.

In addition, by removing stormwater flow with GSI and sewer separation, more capacity is created for transporting sanitary sewage in the infrastructure we have already built. GSI and sewer separation add to our quality life by improving property values and creating amenities in communities such as more pleasantly tailored streetscapes, ponds, parks and wetlands.

is one of collaboration, advocacy and facilitation. Specific actions include:

1. GLWA is co-permittee with DWSD for the NPDES permit, and the NPDES permit requires annual investments of \$2 million to \$3 million per year by DWSD between 2018 to 2023 on Detroit's West Side Sewer District.
2. The NPDES permit also mandates that new redevelopment be performed with sewer separation.
3. GLWA and DWSD are involved with MDOT in planning stormwater solutions for improvements to I-375 and the Gordie Howe International Bridge, both of which include major GSI features.
4. The Erb Family Foundation is examining the role of philanthropy in GSI implementation.
5. Oakland County Water Resources Commissioner has established guidelines for GSI implementation by GLWA Member Partner municipalities in the Twelve Towns drainage district.
6. Stormwater ordinances implemented in each County and in the City of Detroit will lead to construction of GSI as land is developed and re-developed.

Implementation Strategies for Green Stormwater Infrastructure

Private Property GSI: Stormwater ordinances in the City of Detroit and in Wayne, Oakland and Macomb counties have requirements for new development and redevelopment for stormwater runoff capture and peak flow limits which can be implemented through green stormwater infrastructure technology

Publicly Funded GSI: DWSD's GSI program on the West Side of Detroit, described earlier, is an example of a publicly funded effort to reduce combined sewer overflow by implementing a plan to control runoff from 600 acres with GSI.

Grassroots Organizations: There is an active network of grassroots organizations, such as Land and Water Works, Stormwater Hub, and the Detroit Greenway Coalition that promote and build GSI facilities.

Grants and Philanthropy: State and federal grants, and philanthropic organizations such as the Erb Family Foundation are instrumental in providing funding for GSI projects.

Sewer Separation: There are several locations where sewer separation has been found to be cost-effective as a control solution to eliminate CSO discharges. These projects will be implemented in accordance with NPDES schedules.

Highway Improvement: Highways and roadways contribute approximately 30 percent of all stormwater runoff in the GLWA combined sewer area. Highway improvement projects can include GSI swales, infiltration basins, underground storage and stormwater management ponds to reduce runoff.

Clinton River and Lake St. Clair Water Quality

Why Is This Important?

Lake St. Clair is a vital resource for southeast Michigan and southern Ontario, providing residents and visitors with diverse recreational opportunities including swimming, boating, fishing, picnicking, and other aesthetic interests. It is a large and relatively shallow lake impacted by nutrient, pathogen and organic material loadings, which have historically contributed to beach closures and diminished recreational experiences, particularly during the warm summer months when recreational interests peak. As the most environmentally sensitive receiving water in the GLWA service area, tributary communities proactively implemented combined sewer and most sanitary sewer overflow controls. These investments have drastically reduced the pollutant loadings to this cherished water body. However, remaining sources and resultant water quality impairments are still limiting the lake's potential contribution to the economic prosperity envisioned by a Blue Economy. Improvements will further expand recreational interest, which will in-turn increase property values and recreational/tourism revenue.

The Clinton River is a major tributary to Lake St. Clair and provides its own recreational interests to the 1.4 million people living within the watershed. The river supports community and recreational interests such as fishing, canoeing, picnicking, and hiking/biking trails. While Clinton River water quality is generally better than the Rouge River, dry and wet weather sources still impair attainment of water quality goals for the river and lake.

Clinton River and Lake St Clair	
Outcome	How will Improvements to the Clinton River and Lake St. Clair Help?
Protect Public Health and Safety	<ul style="list-style-type: none"> Elimination of remaining SSOs and waterfowl management at local beaches will reduce the risk of pathogen exposure
Preserve Natural Resources and a Healthy Environment	<ul style="list-style-type: none"> Improved aquatic life diversity and sport fishing Stormwater BMPs, like GSI, will provide wildlife habitat, recharge aquifers, and manage excessive streamflow variability
Assure Value of Investment	<ul style="list-style-type: none"> Maximize the value of regionally coordinated in-system storage and RTB dewatering optimization through the ROP Increased treatment of stormwater runoff and combined sewage through RTB treatment capacity expansion
Contribute to Economic Prosperity	<ul style="list-style-type: none"> Water quality improvements will enhance recreational interest, property values, and tourism revenue

What Will Be Done?

The current focus of continued water quality improvements is to complete remaining SSO control projects already underway, to manage waterfowl sources influencing beach closures, and to reduce the volume of treated combined sewage to the Clinton River and Lake St Clair, while Members also implement stormwater best management practices.

Clinton Township is working under an Administrative Consent Order (ACO) to eliminate 9 emergency bypass overflow pump stations and submit a Project Performance Certification (PPC) by February 1, 2021. Control plans include investing over \$30 million in I/I removal, sewer lining, manhole rehabilitation, and the construction of relief sewers. Most of this work has been completed, and four sanitary sewer overflows have been eliminated. The Township intends to keep the four emergency pump stations that would operate during rain events exceeding the 25-year, 24-hour design storm.

The GWK Retention Treatment Basin currently can store up to 124 million gallons of wet weather flow in its basin and in-system storage. A new project by MDOT will remove drainage from I-75 that is now directly connected to the GWK facility, and route that drainage to a new 25-million-gallon storage tunnel under the highway. The new storage tunnel will discharge to the GWK facility. The new effective storage capacity of the GWK facility will be 149 million gallons.

The Macomb County Chapaton Retention Treatment Basin currently can store up to 28 million gallons of wet weather flow in its basin. Two new projects are proposed by Macomb County to increase the size of the retention treatment basin by approximately 17 million gallons and create new in-system storage of 10 million gallons.

In addition, a number of investigations have been performed in the last several years to identify and characterize remaining pollutant sources that impact the Clinton River and Lake St. Clair. For example, a recent study led to the implementation of a program to control Canada Geese at Metropolitan Beach, significantly reducing the number of beach closures. Stormwater runoff has also been identified as a significant remaining source of pathogens and nutrients. Stormwater best management practices, including detention ponds, wetlands and GSI, have demonstrated success as suitable water quality treatment solutions when implemented across urbanized/suburbanized watersheds. Although implementation of such practices is not within GLWA's jurisdiction, GLWA recommends regional coordination via voluntary reporting of Member actions for advocacy, information exchange, and progress reporting. Continuing collaborative efforts are recommended for municipalities, Oakland and Macomb counties, GLWA and the Huron-Clinton Metropolitan Authority. Coordination with the proposed Regional Water Quality Monitoring Program (described previously) is an important element of these recommendations.

Rouge River CSO Control

Why Is This Important?

The Rouge River watershed's 127 stream miles naturally drain 466 square miles of Detroit's west side and its northwestern suburbs and has been greatly influenced by the development history of metropolitan Detroit. Development of the river's natural floodplain has led to typical watershed urbanization issues, including pollution from various sources, flooding, high streamflow variability and habitat degradation.

It is one of 43 Areas of Concern within the Great Lakes watershed.

The Great Lakes Water Quality Agreement (GLWQA) of 1978 between the United States and

Canada requires the development of

a Remedial Action Plan for each Area of Concern. Starting in 1992, Wayne County led the Rouge River restoration initiative through the support of the USEPA Rouge River National Wet Weather Demonstration Project funding. Numerous CSO control, stormwater management, stream restoration, and contaminated sediment projects were completed across Wayne, Oakland, and parts of Washtenaw Counties from 1992 to 2008, including eleven combined sewer Retention Treatment Basins, six Sanitary Retention Basins and one Screening and Disinfection Facility. These improvements reduced CSO discharge volume by 4 billion gallons per year and resulted in a 50% reduction in CSO impacted stream miles. These investments combined with subsequent projects by DWSD through 2013 have dramatically improved dissolved oxygen levels and restored native fish species and other aquatic life to the river. In addition, bacteria levels decreased significantly during wet weather.

However, not all sewer overflows were addressed, and the river is still subject to discharges from 17 yet uncontrolled CSOs, which contribute to exceedances of water quality standards for bacteria and dissolved oxygen.

What Will Be Done?

This Wastewater Master Plan has developed recommendations for CSO control to be implemented in accordance with the 3 phases of water quality goals cited earlier in this Executive Summary.

These recommendations will be evaluated in more detail in a subsequent Long Term CSO Control Plan that is required by the NPDES permit. The Long Term CSO Control Planning effort will identify sites for

ROUGE RIVER CSO CONTROL	
Outcome	How will Rouge River CSO Control Help?
Protect Public Health and Safety	<ul style="list-style-type: none"> Northwest Interceptor Diversion to the Oakwood Retention Treatment Basin will reduce the risk of SSO and basement flooding.
Preserve Natural Resources and a Healthy Environment	<ul style="list-style-type: none"> The proposed plan minimizes the frequency and volume of Rouge River CSOs through early action projects.
Assure Value of Investment	<ul style="list-style-type: none"> Program for scheduled inspections, replacement and rehabilitation.
Contribute to Economic Prosperity	<ul style="list-style-type: none"> Sewer separation is recommended in areas along the Rouge River where separation is cost-effective and can be performed in conjunction with improved streetscapes and neighborhood and commercial amenities.

new facilities, perform additional detailed surveys, and include the additional metering and modeling required for preliminary design of facilities.

How Will It Be Implemented?

The proposed CSO controls will be implemented in a series of three major phases. Phase 1: System Optimization phase will include a new project to divert flow from the Northwest Interceptor to the existing Oakwood RTB. The Oakwood RTB has available capacity to receive flow that currently overloads the Northwest Interceptor. Phase 1 will also include the completion of several committed CSO control projects by the City of Dearborn and the Macomb County Public Works Office, continued implementation of the green stormwater program by DWSD in Detroit, and expansion of this program to include sewer separation in the West Warren Siphon District of Detroit. Finally, Phase 1 includes a new project by GLWA to expand its in-system storage facilities to capture overflows to the Rouge River from small storms.

Small Storms Matter

Over 90 percent of annual rainfall occurs in storms with a rainfall depth of 1-inch or less. Storms with a depth 1-inch occur at a frequency storm of approximately once per month.

25 percent of annual wet weather pollutant loads enter our waterways during storms of 1-inch depth or less.

Significant water quality benefits can be realized by controlling small storms

Phases 2 and 3 include other projects by GLWA to expand in-system storage, projects by DWSD for sewer separation, and new CSO controls by the City of Inkster, Redford Township and Dearborn Heights. Phase 2 projects by DWSD include more sewer separation and more green stormwater infrastructure projects.

Sewer separation is proposed where the capacity and configuration of the local collection systems are the root cause of combined sewer overflows. In these situations, sewer separation is a cost-effective alternative. Sewer separation should proceed with initial sewer investigations to determine if siphon capacity increases or other improvements could reduce overflow frequency with low cost solutions in the near term. These initial improvements would be followed by sewer separation, generally with the construction of new separate storm drains. Sewer separation should be scheduled with other improvements for water main improvements, street resurfacing, DTE gas and electrical lines, and lead service lateral replacements. Multiple departments of the City should participate in this planning, including: Water and Sewerage, Buildings, Safety Engineering and Environment, Public Works, Neighborhoods, Fire, Police, Housing and Revitalization, Parks and Recreation, Planning and Development.

In Phase 3, netting and in-line disinfection would be added to any outfalls with significant frequency and volume. The determination of which outfalls require netting and disinfection would be made after continued receiving water quality monitoring and after optimization of the in-system storage facilities to minimize the number of active outfalls.

Detroit River CSO Control

Why Is This Important?

The Detroit River prompted early development of the City of Detroit because it provided a sustainable drinking water supply and a vast shipping and commerce route connecting ports along lakes Superior, Michigan and Huron to Lake Erie. As the City and suburbs developed, the river increasingly supported new recreational and aquatic life uses, including Belle Isle Park, the International Fish and Wildlife Refuge, the River Walk, marinas and yacht clubs, cruise ships and most recently plans for the Ralph C. Wilson, Jr. Centennial Park.

The 32-mile long river is the eighth largest river by discharge in the United States with an annual average flow of approximately 190,000 cubic feet per, and average velocity of 3 feet per second. Its high discharge volume and velocity together allow for a large assimilative capacity for pollutants, as a result existing water quality is good with water quality standards met most of the time. However, remaining CSOs cause periodic exceedances of bacteria standards and accumulation of sanitary trash along the Detroit shoreline during and after rainfall events.

The water level in the Detroit River rises and falls in cycles with the level of the Great Lakes. In 2019, the Detroit River reached a new record level at approximately the 100-year flood stage during July 2019. The high river level can reduce the volume of combined sewer overflows, but it can also add river inflow to the collection system and consume valuable conveyance and treatment capacity.

Controlling the nutrient load from the Detroit River to Lake Erie is an international water quality priority. GLWA and other agencies in the United States and Canada have important roles in reducing phosphorus loads from the WRRF and combined sewer overflows.

What Will Be Done?

Similar to the Rouge River, this Wastewater Master Plan has developed recommendations for CSO control on the Detroit River that will be evaluated in more detail in the upcoming Long Term CSO Control Plan.

DETROIT RIVER CSO CONTROL	
Outcome	How will Detroit River CSO Control Help?
Protect Public Health and Safety	<ul style="list-style-type: none"> CSO controls for the Detroit River have been planned with collaboration with the proposed Ralph C. Wilson Park and swimming beach near Rosa Parks Boulevard.
Preserve Natural Resources and a Healthy Environment	<ul style="list-style-type: none"> The proposed plan minimizes the frequency and volume of Detroit River CSO through early action projects.
Maintain Reliable, High Quality Service	<ul style="list-style-type: none"> Future interconnections between the Detroit River Interceptor and the North Interceptor East Arm are proposed to make future pipeline maintenance and rehabilitation more efficient.
Assure Value of Investment	<ul style="list-style-type: none"> Program for scheduled inspections, replacement and rehabilitation.
Contribute to Economic Prosperity	<ul style="list-style-type: none"> Sewer separation is recommended in areas along the Detroit River where separation is cost-effective and can be performed in conjunction with improved streetscapes and neighborhood and commercial amenities.

How Will It Be Implemented?

The proposed CSO controls for the Detroit River are recommended for implementation in a 3-phase program. In Phase 1, improvements to regulator settings and hydraulic grade line control will reduce the frequency and volume of combined sewer overflows along the Detroit River Interceptor (DRI). The System Optimization includes recommendations from the Interim Wet Weather Operating Plan to increase the size of regulator orifices from several trunk sewers to the DRI. The larger openings will allow the DRI to fill to capacity during storm events. The DRI will also benefit from the new project to divert flow from the Northwest Interceptor to the existing Oakwood RTB. The Northwest Interceptor Diversion will reduce the flow from the NWI to WRRF Pump Station 1 and Pump Station 2 so that more capacity can be dedicated to the DRI in large storm events. Another Phase 1 project includes the connection of the Meldrum Sewer to the existing Leib Screening and Disinfection Facility. This connection will be the first step to eliminate untreated discharges from outfall B-007.

Phases 1 and 2 for the Detroit River include collaborative sewer separation of approximately 5,500 acres within the City of Detroit. These collaborative projects will take place through highway improvements by MDOT for the Gordie Howe Bridge and improvements to I-375 and I-94.

Other improvements in Phase 1 will include:

1. Piloting of netting devices for active outfalls upstream of the proposed Ralph C. Wilson, Jr. Centennial Park to be constructed to the west of downtown Detroit.
2. Improvements to the Conner Creek RTB to create a shunt channel and isolate first flush capture.

Implementation Summary

This Master Plan proposes a diverse array of wastewater infrastructure investments for the WRRF, regional collection system, and CSO control facilities across the GLWA service area for a 40-year planning horizon. The Adaptive Integrated Plan developed by GLWA and its Member Partners leverages the power of regional optimization and the flexibility of adaptive management to cost effectively achieve the shared desired outcomes at a pace that manages affordability. This is accomplished through a phased implementation strategy spanning multiple regionally integrated parallel paths as described in prior sections and depicted in the graphical schedule below. The Plan includes three phases of progress based on an adaptive framework that uses progress assessments and plan refinements to maximize the value of future investments. Projects and programs that bring the most value at the least cost are recommended for early implementation, whereas projects with fewer benefits are scheduled for later in the implementation timeline. Several high value Phase 1 projects are already underway, including the Northwest Interceptor Diversion to the Oakwood RTB and several quick wins as described further in Section 9. Phase 2 and Phase 3 projects are identified as adaptive, in that they might be refined following assessment of the progress achieved and lessons learned realized through Phase 1.

This regionally integrated plan relies on robust partnerships with Member Partners, Tier 2 customers, EGLE, MDOT, and City Planning to capitalize on cost optimization opportunities.

GLWA is committed to serving as the hub utility to coordinate, integrate, and optimize the projects and progress of the region throughout the implementation of this Master Plan. GLWA has already begun developing these partnerships with demonstrated early successes and is adapting its partnership communications to facilitate the regional collaboration necessary to realize the vision of this Master Plan.

How Does the Adaptive Integrated Plan Manage Affordability?

GLWA and its Member Partners clearly understand that one of the most challenging elements of long-term planning is the allocation of scarce financial resources amongst competing needs and keeping improvements affordable to all ratepayers. GLWA utilized a cost optimization decision support system to evaluate alternative control strategies for achieving desired outcomes. This cost optimization process identified synergistic regional collaboration opportunities that can contain the cost of improvements; such as a GLWA and Member coordinated Regional Operating Plan and the coordination of sewer separation and green stormwater infrastructure projects with MDOT and City Planning.

The Plan Will Enhance Quality of Life Across the Region

The GLWA is committed to partnering with its Members, other wastewater service providers, universities, and state and regional agencies to continuously investing to improve the water quality of the Rouge River, the Clinton River, Lake St. Clair and the Detroit River. The dividend is an improved quality of life for the region and a safer Great Lakes in the future.

The GLWA Adaptive Integrated Plan, as shown in Figure 1-1, addresses affordability using a combination of strategies which together manage the financial burden on ratepayers. These include:

1. Plan for the necessary costs associated with WRRF and collection system rehabilitation and asset management programs that maintain reliable high-quality service and prioritize accordingly
2. Apply regional integrated planning principles using cost optimization decision support systems to identify and prioritize projects that maximize desired outcomes for the lowest regional cost
3. Build and leverage synergistic opportunistic partnerships that reduce cost through collaboration, economy of scale, and shared objectives
4. Select projects that produce additional community benefits that promote economic prosperity and elevate quality of life
5. Phase in full compliance consistent with the NPDES permit through development of the Long Term CSO Control Plan updates due to EGLE in 2022
 - Schedule lower cost CSO control projects and asset management investments for early in the planning period (2023-2027 per NPDES 15.f.2)
 - Schedule the highest cost projects for CSO control later in the planning period
 - Continue utilizing and advancing the decision support system to support design and construction of Phase 1 projects and thereafter to assess progress and refine adaptive phase 2 and 3 project technologies, configurations, sizing, and implementation timing
 - Conduct financial capability evaluations with each permit renewal cycle and work with EGLE to develop adaptive implementation commitments, if necessary

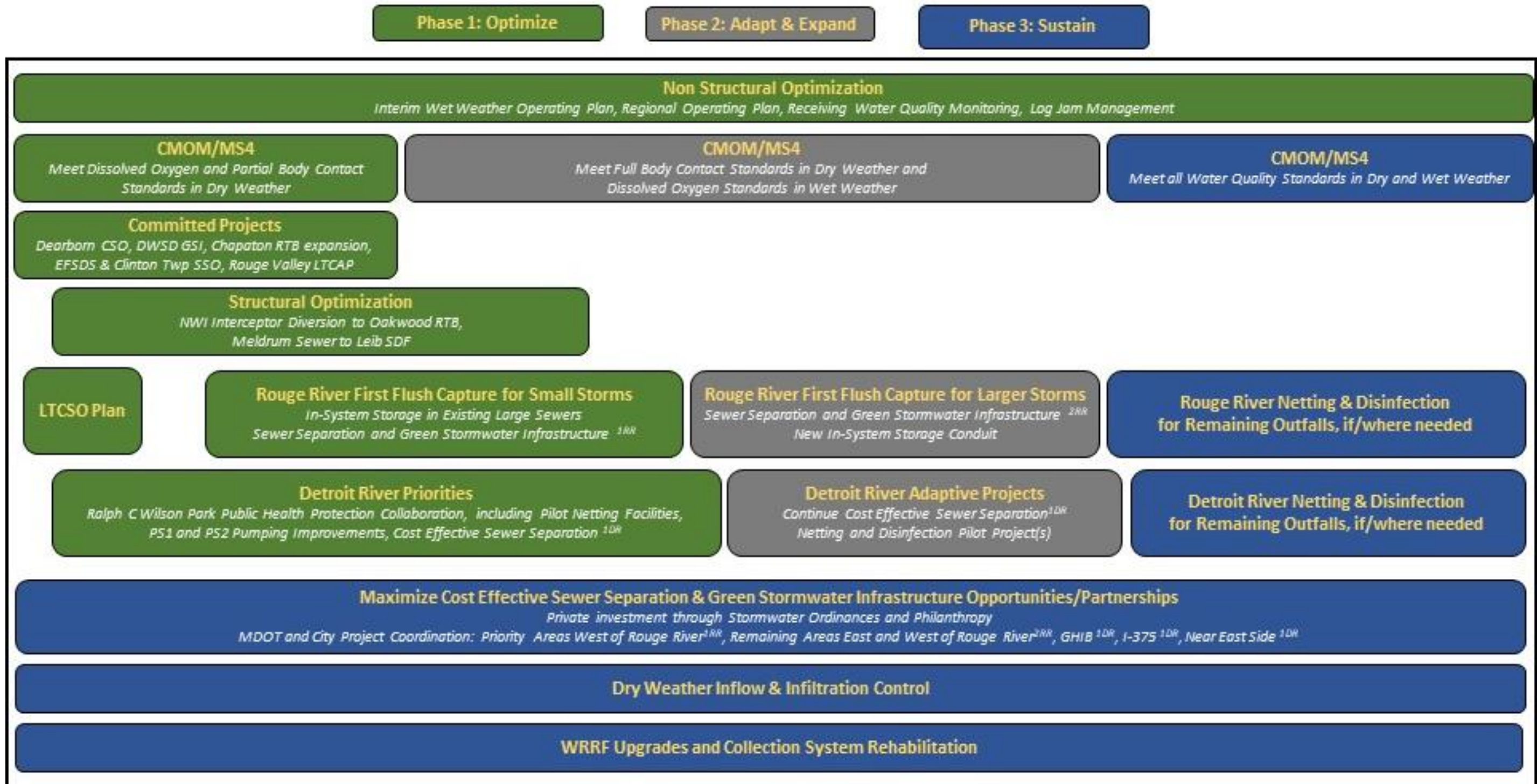

Figure 1-1. GLWA Adaptive Integrated Plan

Section 2

Planning Process and Report Introduction

2.1 Background

To help guide the development of its comprehensive regional forty-year Wastewater Master Plan, the Great Lakes Water Authority (GLWA) appointed a Steering Committee consisting of representatives of the customer communities and counties within its wastewater service area as well as representation from the Michigan Department of Environment, Great Lakes and Energy (EGLE) and the Michigan Department of Transportation (MDOT). Through a series of meetings, using a consensus building process, the Steering Committee developed the following mission statement, underlying assumptions and guiding principles to guide the planning process.

The Mission Statement briefly states what the GLWA Master Plan does, what the benefits are, and who benefits. The Underlying Assumptions identify constraints that are widely accepted and are largely outside the immediate control of those charged with overseeing the development or implementation of the GLWA Master Plan. The Guiding Principles state the intent of those developing the plan on how they intend to evaluate the appropriateness of the specific recommendations and actions developed as part of the plan.

The Planning Process is outcome based and is similar to the approach adopted by the Southeast Michigan Council of Governments (SEMCOG) for guiding regional planning and also that proposed in the Governor's 21st Century Infrastructure Commission Report.

2.2 Mission Statement

The GLWA Master Plan will identify actions needed to support specific management outcomes identified by the Steering Committee including financial strategies that are needed to provide a highly efficient and reliable regional wastewater collection and treatment system that protects public health, safety and property, is affordable and sustainable, and supports a healthy environment and viable economy for those residents and businesses in the communities served.

2.3 Underlying Assumptions

1. The GLWA is Michigan's largest regional wastewater collection and treatment system encompassing seventy-seven communities in southeast Michigan and serves approximately three million people, one third of the state's population. The discharges from the GLWA's wastewater transport and treatment system and its customer communities are subject to federal and state National Pollution Discharge Elimination System (NPDES) permitting and water quality standards (WQS) designed to protect public health, safety and property, as well as domestic, commercial, industrial and recreational water uses and aquatic organisms.
2. The GLWA and its customer communities will maintain compliance with their federal and state mandated requirements and will conform to the provisions of the 2014 Memorandum of Understanding between the City of Detroit, the counties of Macomb, Oakland and Wayne, and the State of Michigan.

3. Basement flooding from sanitary sewer backups, untreated CSOs, SSOs, and illicit sanitary connections to the stormwater systems create immediate threats to public health and safety that require priority, short term actions by the GLWA and its customer communities.

2.4 Guiding Principles

1. In order to take advantage of the concepts contained in the United States Environmental Protection Agency (USEPA) Integrated Planning Process that offers more flexible regulatory compliance options and encourages regional approaches to wastewater management, the GLWA will characterize stormwater loads and impacts within the scope of its forty-year plan. The GLWA will determine if investing in stormwater best management practices (BMPs) and/or in innovative regional solutions are cost effective in achieving the desired water quality outcomes. (Note: The MDEQ has agreed to provide information and data analyses on the relative impact on water quality of stormwater discharges versus those of CSOs and SSOs regardless of their respective loadings.)
2. The GLWA Master Plan will incorporate the recommendations of the State of Michigan's Water Strategic Plan and The Governor's 21st Century Infrastructure Commission Report to help foster coordination and essential cooperation between the state and the communities served by the GLWA wastewater collection system. The plan will also be adaptable to integration with existing or future watershed plan objectives developed by communities within the GLWA wastewater service area whenever feasible.
3. Economic prosperity enables investment in quality service. Recognizing this interdependence of economic prosperity, a well-functioning infrastructure, and the quality of life for residents and the environment is essential to the success of the GLWA Master Plan.
4. The GLWA Master Plan is designed to promote coordination, cooperation and communication among all public and private entities, and individuals within the GLWA service areas that depend upon a reliable/affordable wastewater transport and treatment system.
5. The underlying assumptions, desired outcomes and performance measures of this GLWA Master Plan need to be examined periodically and adjusted to make sure that new information, changing economic conditions or demographics and/or new technologies are considered and that appropriate modifications to planned operations and investments are initiated.
6. GLWA Master Plan recommendations and decisions related to new investments will be based on a consideration of the effectiveness of various options in achieving desired outcomes which includes affordability with respect to those ultimately responsible for financing.
7. The operating, maintenance and capital expenditures of the GLWA will be assessed fairly and transparently to customers based upon objective measures that best reflect individual contributions of wastewater to the GLWA system for transport and treatment. These measures will be informed by the data and analyses developed in the planning process but independently and formally adopted and periodically updated as Sewer SHARES by the GLWA Board.

2.5 Planning Process

In recognition of the complexity of the wastewater collection and treatment system and the overlapping impacts of so many actions of government, the GLWA and its Steering Committee have agreed that the GLWA Master Plan should be based on supporting five basic outcomes: (1) Protect Public Health and Safety; (2) Preserve Natural Resources and the Environment; (3) Maintain Reliable, Quality Service; (4) Assure Value of Investment; and, (5) Contribute to Economic Prosperity. These outcomes are purposely stated in a way that encompasses various functions at all levels of government to facilitate integrated public and private investment decisions-making.

The Measures, examples that follow each of the Desired Outcomes, are the result of initial efforts of the Steering Committee to identify performance indicators that will be used by managers to determine whether or not the desired outcomes are being achieved. The Measures will most likely be modified or expanded as new information is developed during the planning process. Similarly, the Data Collection and Analyses listed under each of the Desired Outcomes, is a preliminary list of basic information and insightful interpretations that are now seen as essential. It is recognized that detailed work plans may well demonstrate that additional or different data collection or analyses is needed. Management decisions in the future will be driven by what is measured and it is critical that the performance measures and supporting data and analyses be scientifically valid and truly indicative of the outcomes.

The following Desired Outcomes and related Measures, Data Collection and Analyses can serve as a template for the GLWA and its Steering Committee upon which individual work plans can be evaluated.

2.6 Desired Outcomes

2.6.1 Protect Public Health and Safety

A high-level priority will be to consider actions that minimize threats to public health and safety, and damage to property.

2.6.1.1 Measures

The water areas covered with public health warnings for partial body contact activities such as wading, fishing and boating (Public Health).

The frequency and number of basement flooding events (Public Health/Property Damage).

The incidences related to wastewater infrastructure failures (Public Safety/Property Damage).

Discharges of untreated CSOs, SSOs and illicit connections to ground and surface waters within the GLWA service area.

2.6.1.2 Data Collection and Analyses

Inventory of current untreated discharges of CSOs, SSOs and contaminated stormwater discharges to waterways and information on frequency and priority for control relative to cost, affordability and relative contribution to eliminating or reducing human exposure and property damage.

Inventory of current basement flooding locations, numbers and frequency as well as likely causes and the projected cost of remedies.

Probability of infrastructure failures based on age and/or issues related to design, construction or deferred maintenance issues.

2.6.2 Preserve (and Restore) Natural Resources and a Healthy Environment

Recognizing that quality of life for customers is partly defined by the environmental condition of their community including access to recreation; the analyses for evaluating the merits of various actions will include benefits to natural resources and the environment.

2.6.2.1 Measures

Number of locations where odors or visible signs of unsightly debris in waterways occur following SSOs, untreated CSOs or storm water discharges (Aesthetics/Quality of Life).

Percentage of time when critical water quality standards such as dissolved oxygen are being met, indicating improved conditions for beneficial aquatic organisms (Water Quality/Healthy Environment).

Acreage and water storage capacity of former impervious surfaces converted to new green Stormwater infrastructure (GSI).

Compliance with conditions or regulatory compliance orders contained in the GLWA/Detroit Water and Sewerage Department (DWSD) joint NPDES permit as well as contracted customer compliance with their NPDES permits/compliance orders.

Objectives achieved that are contained in watershed plans developed by communities within the wastewater service area of the GLWA.

2.6.2.2 Data Collection and Analyses

Determine cost for creation of various forms of GSI and priority locations for reducing impervious surfaces and projecting subsequent reductions in pollutant loadings.

Inventory of current CSOs, SSOs, illicit stormwater discharges to waterways and information on frequency, volume, contribution of pollutants and priority for control relative to cost, affordability and relative contribution to achieving WQS and NPDES permit requirements.

Current compliance status of joint GLWA/DWSD NPDES permits and those of the contracted customers.

2.6.3 Maintain Reliable, High-Quality Service

Long term fiscal sustainability relies upon a customer base willing to support the cost of service. Meeting customer expectations for reliable, high quality service hinges on recruiting and maintaining qualified employees to operate and manage the complex GLWA system.

2.6.3.1 Measures

Confidence levels by first and second-tier contract customers, communities, residents and businesses that wastewater services provided by GLWA are reliable and that system issues and problems are addressed promptly and efficiently.

Willingness of customers, communities, residents and businesses to support fees and assessments for operation and maintenance (O&M) and capital improvements to support GLWA wastewater services.

Stability of rate base to assure that sufficient funds are available to support wastewater services at affordable costs to customers.

Ability to fill key system operators, engineers, technicians, support staff and management positions with qualified individuals, trained and recruited from the GLWA service area.

2.6.3.2 Data Collection and Analyses

Survey to determine baseline satisfaction levels for the services provided by GLWA and perceptions of the relative cost and reliability.

Analyze range of costs and rates for comparable wastewater services in other similar metropolitan areas in the United States with those in the GLWA service area based on actual dollars per household and as a percent of household income.

Identify opportunities to support and expand current DWSD program designed to work with unions and schools to promote careers in wastewater to generate future professional, technical, and support employees that are needed to manage and operate local and regional wastewater transport and treatment systems in SE Michigan.

Identify successful approaches used elsewhere in the country to inform and educate the public on the value of clean water and cost of wastewater treatment. Assessment of the adaptability of those successful programs for use by the GLWA and their customer communities.

2.6.4 Assure Value of Investment

Maintaining public support for paying rates that reflect the full cost of service is accompanied by a fiscal obligation for managers of the system to assure that costs are optimized.

2.6.4.1 Measures

Capacity of current system to transport and treat flows after implementing real-time control facilities integrated with improved storm event forecasting/flow monitoring.

Changes in system flows versus rainfall volume.

Treatment capacity, resource recovery and energy use at the Water Resource Recovery Facility (WRRF).

Funds allocated to support O&M/replacement of existing infrastructure compared to funds allocated to strategic investments in new grey infrastructure.

2.6.4.2 Data Collection and Analyses

Develop and implement use of improved forecasting and related real-time operational controls to demonstrate cost and feasibility of increasing capacity of current system to transport and treat wastewater.

Examination of system capacity achieved through improvements in integrated regional planning and/or wastewater discharge reduction incentives.

Collect and analyze data at the WRRF, and model alternative operational scenarios to optimize resource recovery, increase treatment capacity and reduce energy and other operational costs.

Inventory existing infrastructure assets to determine O&M costs, identify operation or maintenance shortfalls, determine life expectancy and project funding needs to assure sustained, reliable operation of facilities and structures to meet agreed upon present and future needs.

Evaluate potential new grey infrastructure costs and benefits in terms of achieving outcomes compared to increased investments in existing infrastructure or new investments in non-structural alternatives.

Modeling flows, and monitoring quantity and quality of overflows in system to determine current capacity, opportunities for increasing capacity through operational changes and to evaluate other structural and non-structural options to better achieve desired outcomes.

2.6.5 Contribute to Economic Prosperity

Leveraging needed infrastructure investments to encourage maintenance or enhancement of residential property values and/or job producing private investments through public/private partnerships that support coordinated and integrated planning as well as contributions to new construction, and O & M costs.

2.6.5.1 Measures

Community changes over-time in: (1) value of residential, commercial and industrial property; especially those adjacent to water resources; (2) average household income levels corrected for inflation; (3) unemployment or underemployment rates; and (4) new investments in residential of commercial/industrial properties.

2.6.5.2 Data Collection and Analyses

Establish baseline for selected measures as well as method and frequency for recording any changes.

Collect information on infrastructure improvements that have resulted in measurable gains in economic prosperity elsewhere in Michigan or in other metropolitan areas in the country. Explore how such identified opportunities could be encouraged and supported in the GLWA service area.

Identify how current aspects of wastewater services limit or constrain business expansions or lead to constraints or closing of facilities (e.g. reliability, capacity, cost of service, etc.).

Examine alternative approaches to integrating sanitary infrastructure improvements to support various federal, state and regional efforts for new economic development initiatives.

2.7 Report Introduction

The following sections of this report present the planning approaches, analytical methods, findings, conclusions and recommendations of the wastewater master plan. The Wastewater Master Plan is presented in the series of reports listed in Table 2-1. Information within this report is based on data reviewed and analyzed through December 2019.

Table 2-1. Work Products of the Wastewater Master Plan

Work Products of the Wastewater Master Plan
▪ Wastewater Master Plan Report
▪ Executive Summary
▪ PowerPoint Summary Presentation for GLWA Member Audiences
▪ Optimization of Regional Operations Report
▪ Regional Operating Plan
▪ Technical Memorandum 1: West Side Model Integration
▪ Technical Memorandum 2: Planning Information
▪ Technical Memorandum 3: WRRF Models and Performance Evaluation
▪ Technical Memorandum 4A: Regional Wastewater Collection System Model Development
▪ Technical Memorandum 4B: Receiving Water Quality Models
▪ Technical Memorandum 4C: Regional Collection System Model Simulation of Alternatives
▪ Technical Memorandum 4D: Regional Collection System Model Documentation
▪ Technical Memorandum 5A: WRRF Liquid Processes
▪ Technical Memorandum 5B: Sludge and Biosolids Processes
▪ Technical Memorandum 6A: Collection System Long Term Planning
▪ Technical Memorandum 6B: Lake St. Clair Beach Closures Source Assessment Screening Study
▪ Technical Memorandum 7: Cost Estimates and Financial Analysis
▪ Technical Memorandum 8: Flow Metering Program
▪ Technical Memorandum 9: WRRF Site Analysis
▪ WRRF Plant Hydraulics Model
▪ WRRF Process Model
▪ Regional Wastewater Collection System Model
▪ Rouge River Water Quality Model
▪ Collection System Model Maintenance Procedures
▪ Project GIS Data Files

Section 3

Regional System

3.1 General

The GLWA regional wastewater collection system (RWCS) includes portions of Wayne, Oakland and Macomb counties. The regional collection system covers parts of the watersheds of the Rouge River, Clinton River, Lake St. Clair, and Detroit River as shown on Figure 3-1. Twelve other wastewater service providers operate within or at the boundary of GLWA's service area.

GLWA operates the regional collection system and Water Resource Recovery Facility through a lease from the City of Detroit. The lease began with GLWA's formation in 2016, and the lease extends for 40 years. The leased facilities include 183 miles of trunk sewer, interceptors, and outfalls; 6 pumping stations, 8 retention treatment basins and screening and disinfection facilities, the Water Resource Recovery Facility (WRRF) and associated metering and control facilities.

GLWA holds 32 wastewater service contracts with counties, drainage districts, and local units of government in the Detroit metropolitan area. Entities that contract with GLWA for wastewater service are called Members. The City of Detroit Water and Sewerage Department is a co-permittee with GLWA on the NPDES permit and is also a Member. The total service area in 2018 is approximately 944 square miles.

This section describes the leased facilities of the GLWA and the wastewater collection systems of the Members.

3.2 History and Governance Structure

3.2.1 History

This section provides a brief overview of the infrastructure history and the current governance structure of GLWA. Regulatory history is described in Chapter 4.

The earliest sewers in Detroit were constructed in the mid-1800s to convey flows to the Detroit River. These initial sewers were combined sewers built to convey both sanitary flows from properties and storm flows from the streets. By 1910, there were over 600 miles of sewers in Detroit discharging untreated sewage into the Detroit River.

These discharges contaminated the river, causing water quality and public health problems for Detroit as well as downriver communities on both sides of the river. In 1909, the Boundary Waters Treaty established the International Joint Commission largely to deal with this issue. The Fairview Sewer, built in 1912, diverted sanitary flows from the Grosse Pointes and the east side of Detroit to downstream of the intake for the Water Works Park drinking water treatment plant, thus partially solving a public health issue for Detroit.

As the auto industry grew and population increased, needs for wastewater collection and conveyance grew. In 1925, construction was started on a wastewater treatment plant near the confluence of the Rouge River and the Detroit River. Some of these facilities remain in service as part of the WRRF today. The Detroit River Interceptor (DRI), running from the Fairview Pump Station to the WRRF, was also constructed in the 1920s and 1930s.

In the 1930s, in response to continuing wastewater discharges from Conner Creek into the Detroit River upstream of Water Works Park, relief sewers were constructed.

As the Depression deepened, work on the wastewater treatment plant was halted. Federal public works programs reinvigorated the project, and the WRRF became operational in 1940 as a primary treatment plant with one raw wastewater influent pumping station. The Oakwood Interceptor from Baby Creek to the WRRF and the DRI became operational at that time. The DRI conveyed sanitary wastewater to the WRRF in dry weather and low flow rates in wet weather.

World War II ushered in another influx of workers as the “arsenal of democracy” geared up to fill the demand for military vehicles. In the 1950s the population of the City of Detroit peaked at about 2.5 million residents. In the 1950s, the exodus from the City of Detroit into suburban areas began, sparked by the creation of the interstate highway system and a change in Federal Housing Authority loan policies that encouraged the move to outlying areas. Continuing population growth and extension of the wastewater collection system increased wastewater flows, and in 1954 the influent pumping station capacity was increased.

In the late 1950s a major program to improve wastewater treatment and regionalize wastewater facilities in the service area began. At this time, many suburban areas were served by on-site wastewater disposal systems (septic tanks and leach fields) or combined sewers with local wastewater treatment facilities (trickling filters/primary tanks). These local facilities overflowed in wet weather and water quality and public health problems were a concern.

By the early 1960s, many suburban wastewater districts were formed and became customers of the City of Detroit. These customers included: Allen Park, Centerline, Dearborn, Farmington, Melvindale, the Evergreen-Farmington and Southeast-Oakland Districts in Oakland County; the Wayne County Rouge Valley District; and the Wayne County Northeast District serving southeast Macomb and northeast Wayne County. Interceptors were built and the suburban facilities were abandoned. Additional rectangular primary tanks were added at the WRRF.

In the late 1960s, the Macomb Sanitary District and the Clinton Oakland District in Oakland County were added as customers. Interceptors and the pumping stations were built to serve these customers. The NI-EA was built from the Northeast Sewage Pump Station to the WRRF but was activated to only Seven Mile Road.

In compliance with the Federal Water Pollution Control Act of 1972 (the Clean Water Act), treatment facilities were upgraded to provide additional primary circular tanks, secondary treatment facilities, including a cryogenic oxygen generation plant, aeration tanks, clarifiers and additional sludge handling capacity. Further upgrades in the 1970s were undertaken to increase removal of solids, minimize phosphorus discharge, and provide disinfection. Many of these projects were funded in part by State of Michigan and Federal water pollution control grants.

As continued suburban expansion occurred in the 1980s and 1990s, Pump Station No. 2 was constructed in the early 1990s and the North Interceptor-East Arm was activated to the WRRF. With Pump Station No. 2 in-service, the primary treatment capacity was increased to about 1540 MGD with the secondary capacity rated at 800 MGD.

Two additional primary circular tanks were built in the late 1990s and when on-line the primary treatment capacity increased to 1,800 MGD with a secondary capacity of 930 MGD. Also, improvements were made to the aeration decks, secondary tanks and the outfall system.

Macomb and Oakland Counties created the Oakland-Macomb Interceptor Drain (OMID) in 2008 and purchased the interceptors and the pumping stations in their communities from the City of Detroit.

The RRO disinfection project was completed and placed on-line in the spring of 2019. This project allows the discharge from the WRRF through the RRO to be disinfected with chlorine.

3.2.2 Governance Structure

Facilities to store and treat combined sewer overflows were constructed starting in the 1980s through the present. As of 2018, there are 26 retention treatment and screening and disinfection facilities, 8 equalization basins, and 18 in-system storage devices in the regional service area,

The Detroit Water and Sewerage Department (DWSD) and its predecessor agencies operated the regional system from the early 1900s to 2016. The Great Lakes Water Authority (GLWA) was established in 2014, and it became fully operational on January 1, 2016. The GLWA is a regional authority which leases regional components of the wastewater and water supply systems from the DWSD. GLWA is governed by a Board of Directors representing the City of Detroit, Wayne County, Oakland County, Macomb County, and the State of Michigan. There are two members representing the City of Detroit and one member from each of the counties and the state.

GLWA operates the regional wastewater collection system through Articles of Incorporation, the Sewer Master Bond Ordinance and the Regional Sewage Disposal System Lease. GLWA holds Wastewater Service Agreements with municipalities and sewer districts that it serves.

Figure 3-1 shows the GLWA wastewater service area and how they align with the watershed boundaries of the Rouge River and the Clinton River watersheds, as well as the areas immediately tributary to the Detroit River and to Lake St. Clair.

Figure 3-2 shows the current organization of GLWA Members.

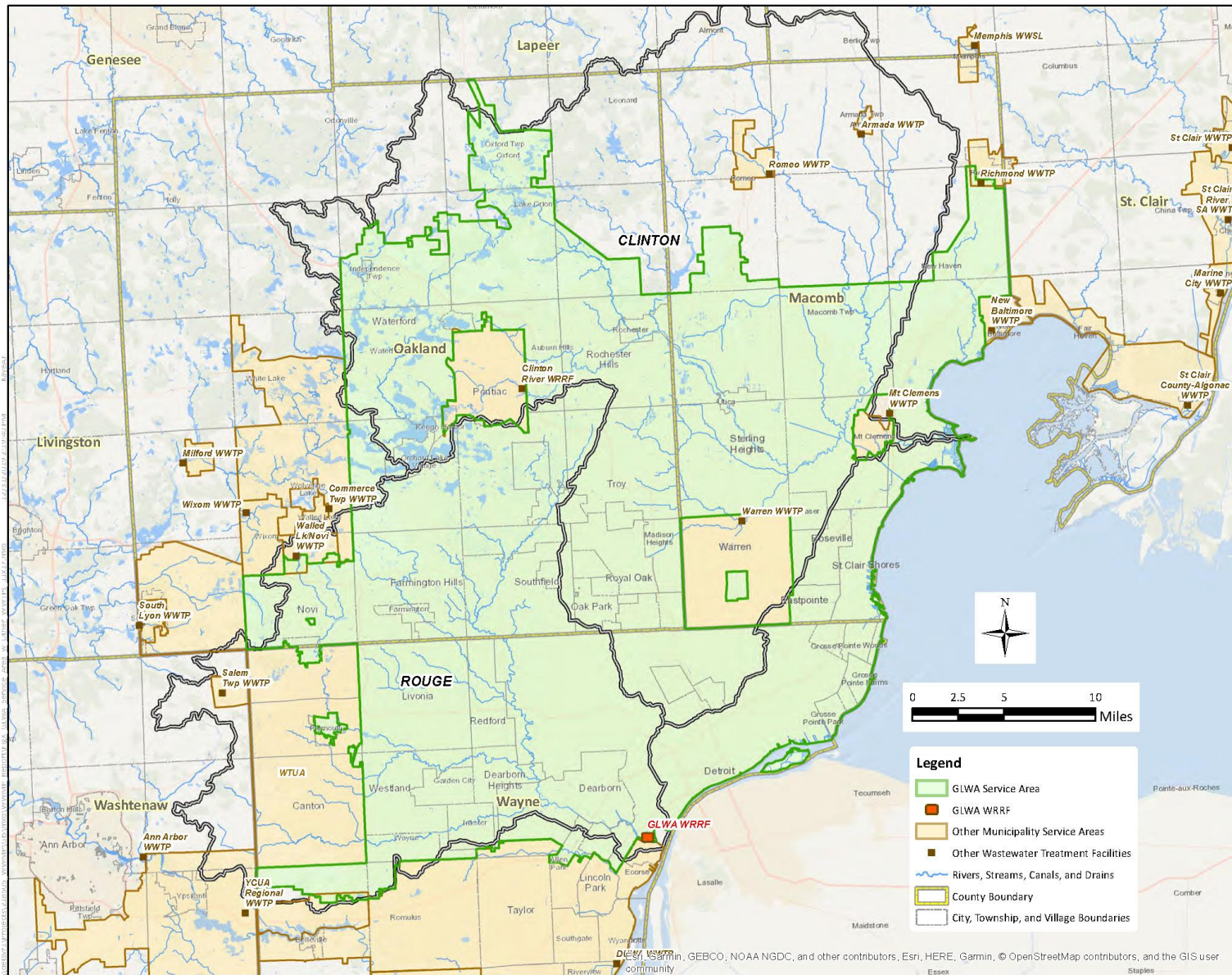
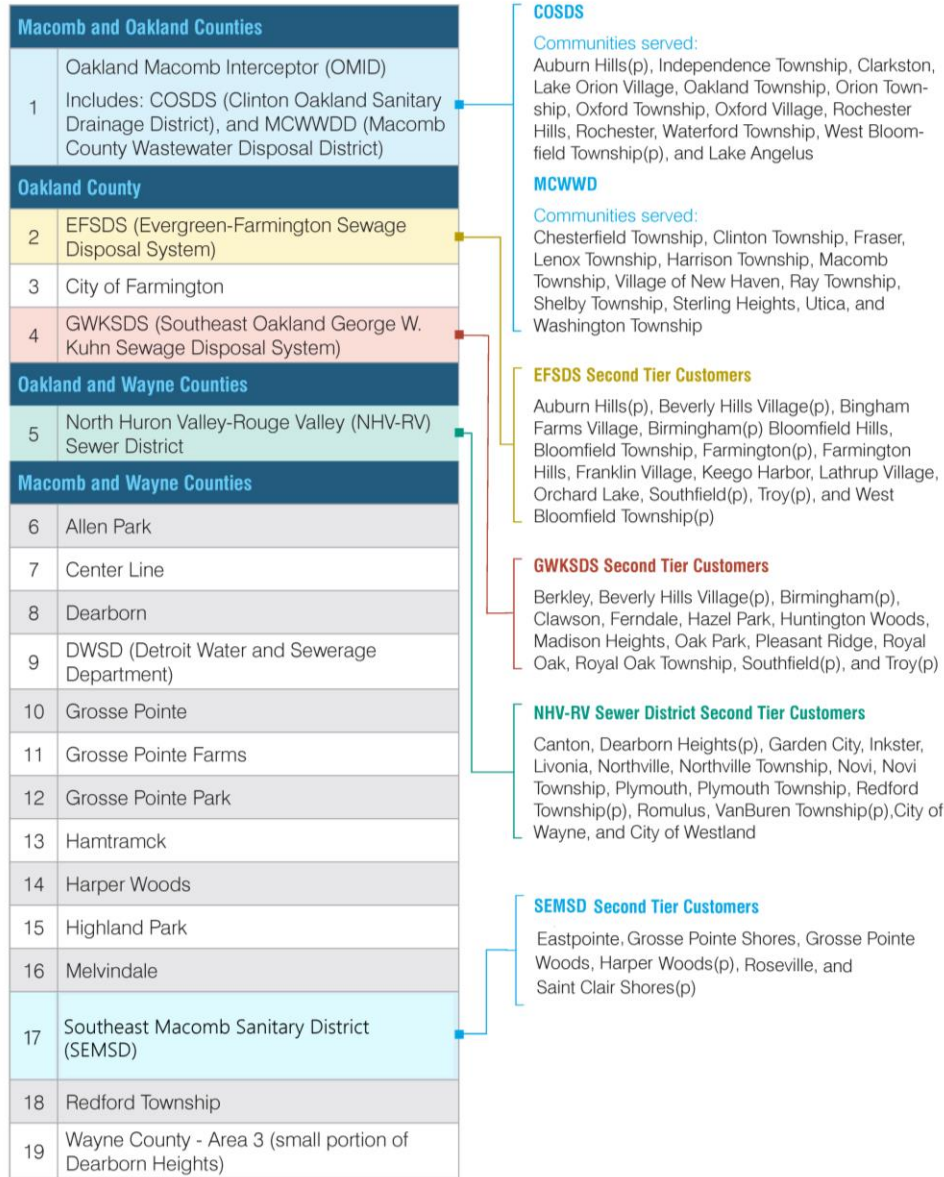

Figure 3-1. GLWA Wastewater Service Area and Watershed Boundaries

3.3 Wastewater Service Districts

The regional collection system is comprised of 19 sewer districts. These districts include areas within the City of Detroit and other municipalities that drain portions of the service area and generally have hydraulic and operational independence during dry weather conditions.

Great Lakes Water Authority (GLWA) Member Organization



NOTE: When a local municipality name is followed by (p), it indicates that the community is only partially served by the disposal district, disposal system or First Tier Customer named. Further, the other part(s) of the community may also be listed under another district, system or First Tier customer.

Figure 3-2. GLWA Member Organization

These sewer service districts are described below and shown on Figures 3-3 and 3-4. The GLWA leased trunk sewers and interceptors that serve these districts are shown on Figure 3-5.

Detroit - Nine sewer service districts: Rouge River, Hubbell, Southfield, Baby Creek, Conner Creek, Oakwood, Central, Fox Creek, and East Jefferson.

Wayne County - Two large sewer districts: North Huron Valley-Rouge Valley and Northeast Wayne County; eight municipality districts: Highland Park, Hamtramck, Dearborn, Allen Park, Melvindale, Grosse Pointe, Grosse Pointe Farms and Grosse Pointe Park; and three small contract areas: Redford Township (2 areas), Dearborn Heights (2 areas), and Harper Woods.

Oakland County - Four sewer districts: Evergreen-Farmington, Southeast Oakland, city of Farmington, and Clinton Oakland (part of the OMIDDD discussed below).

Macomb County - Three sewer districts: Southeast Macomb, city of Centerline, and the Macomb Drain Drainage District (MIDDD). The MIDDD is part of the Oakland-Macomber Interceptor Drainage District discussed below.

Oakland and Macomb – The Oakland Macomb Interceptor Drain Drainage District (OMIDDD) was formed in 2009, and it is jointly operated by Oakland County and Macomb County. It serves both the Clinton-Oakland District and the Macomb District, with their flows conveyed to GLWA via the Northeast Sewage Pumping Station (NESPS).

Section 3.4 provides a combined listing of all regional CSO control facilities, in-system storage devices and control gates, equalization basins, sewer separation projects, GLWA pumping stations, and WRRF capacity improvements along with their construction costs.

The following subsections describe the locations of the individual sewer districts listed above within the regional collection system, and also provide descriptions of the predominant geographical features, land uses, major sewers and CSO control facilities located within each wastewater service district.

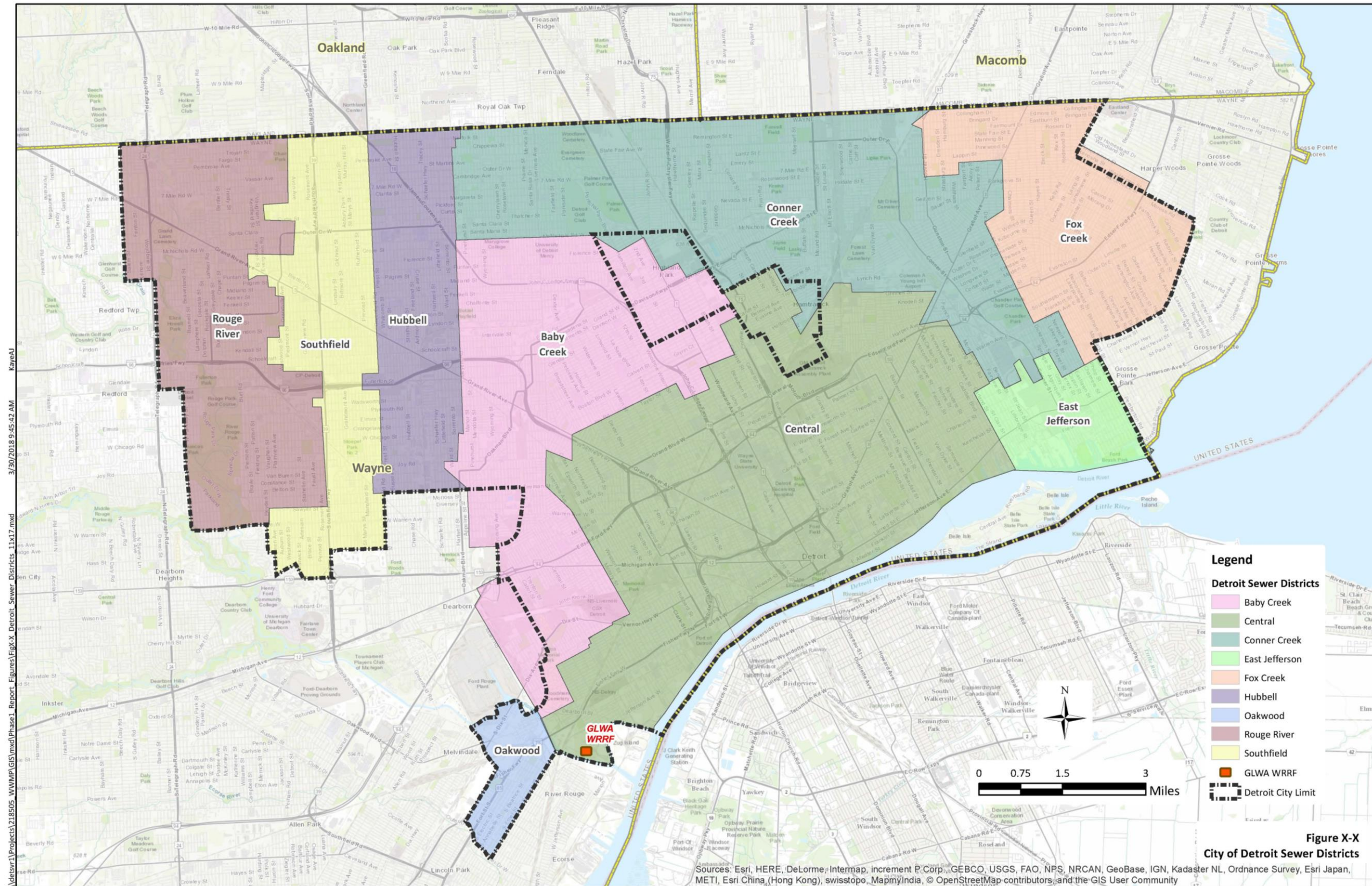

Figure 3-3. Sewer Districts in the City of Detroit

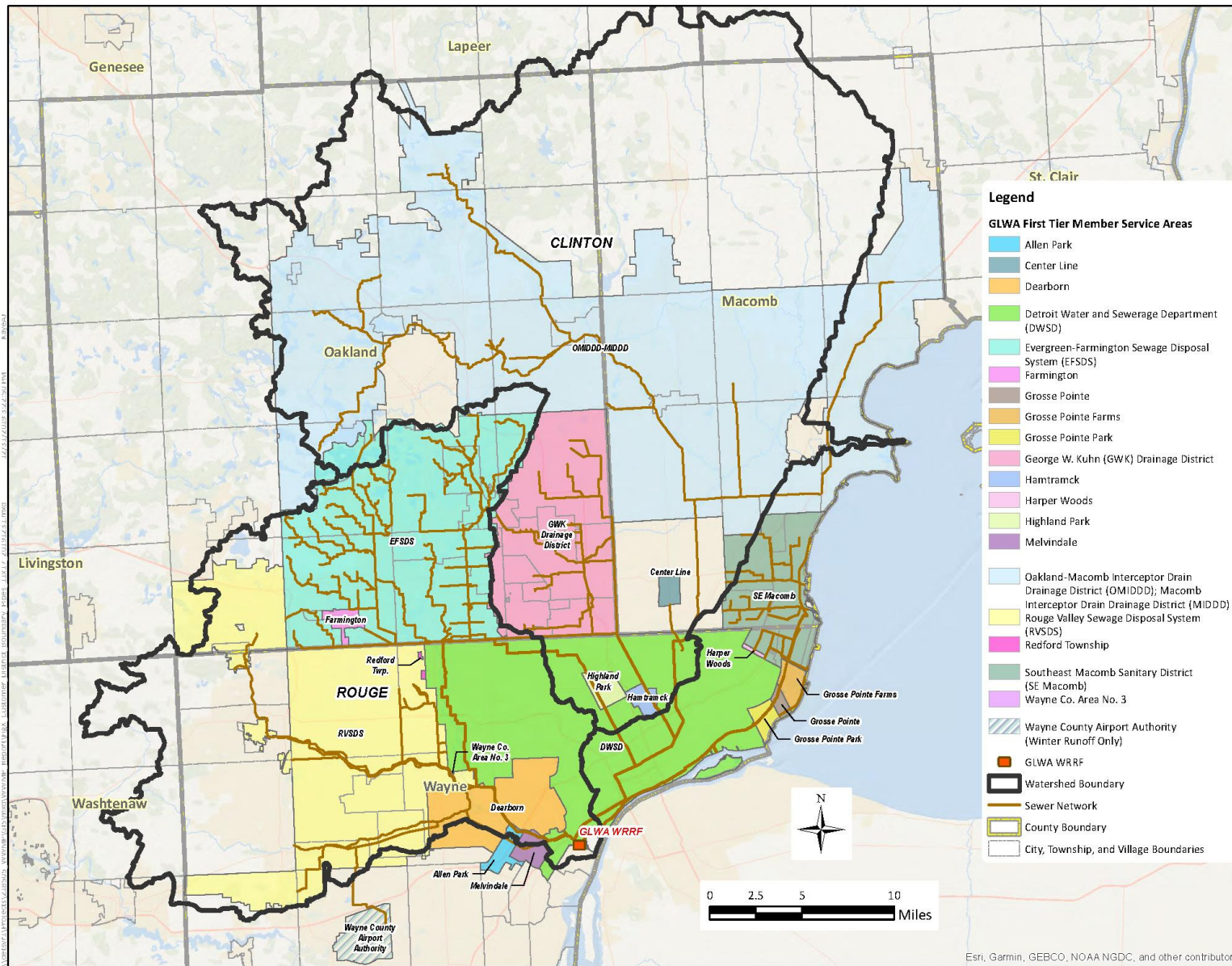

Figure 3-4. GLWA First Tier Member Sewer Service Districts

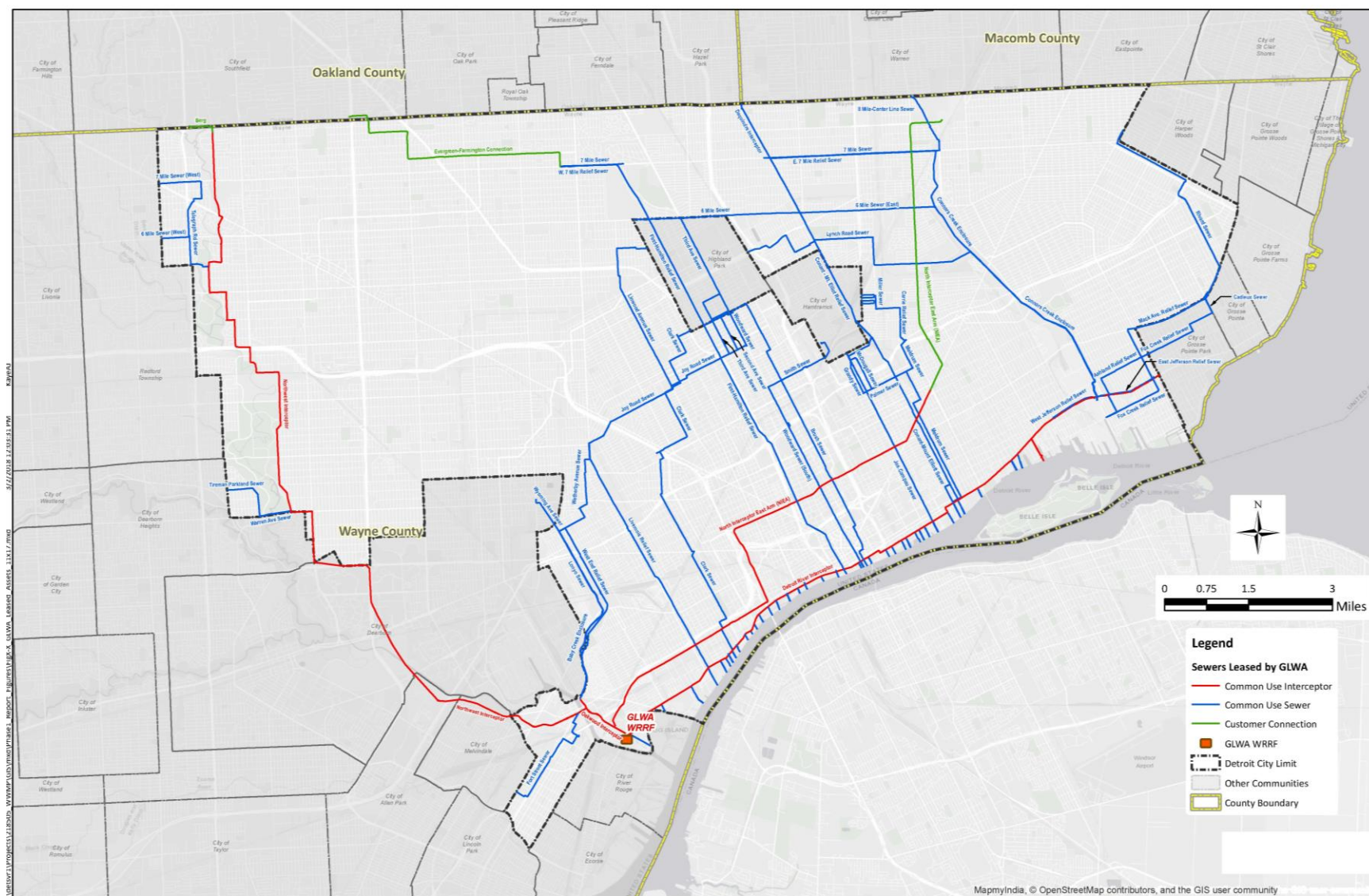

Figure 3-5. GLWA Leased Sewers

3.3.1 Rouge River Sewer District

The Rouge River Sewer District is in western Detroit. It was one of the areas incorporated into Detroit in the 1920s in the city's final expansion to its present limits. The trunk sewers were built in the 1920s and 1930s.

The Rouge River Sewer District lies in the valley of the main branch of the Rouge River. The valley runs from north to south almost at the district's western boundary.

The river valley is a floodplain that extends on both sides of the main river channel and is lined by shallow bluffs overlooking the valley. The surface contours of the area slope gently from the northeast to the southwest, falling approximately 55 feet in seven miles for an average slope of approximately 0.15 percent.

The land use in the district is mainly residential single-family housing and secondarily open space, mostly municipal parkland, public and private golf courses and a cemetery. There are some areas of commercial and industrial activity along the I-96 corridor as it passes through the district. The district area is 10,780 acres.

The Rouge River Sewer District tributary area consists primarily of Detroit, but it also accepts flows from a portion of the city of Farmington and small areas of Redford and Dearborn Heights. The district is served by the Northwest Interceptor (NWI), the only interceptor in the district. The interceptor is located close to the east side of the Rouge flood plain.

Other sewers in the district are trunk and lateral sewers that primarily convey flows within the district west towards the river, where they are intercepted by the NWI. Smaller portions of the district lie to the west of the river. There are four inverted siphons, consisting of small-diameter sewers, to convey dry weather flows under the Rouge River to the Northwest Interceptor from approximately the southern half of the district located on the west. Dry weather flows from the northern half are pumped to the NWI through two 1,100 gpm sanitary pumps at the Puritan-Fenkell Detention Basin.

The interceptor has one operational element in this district, the Warren-Pierson Gate (VR-9), located downstream of the last outfall. This gate is designed to regulate flow from the City of Detroit so that there is capacity for flow from the Wayne County Rouge Valley Sewerage District to enter the NWI in wet weather.

There are 21 outfalls from the district's sewers to the Rouge River divided nearly equally on the east and west sides of the river. The flows from these outfalls are generally considered combined sewer overflows. In addition, the district contains 25 backwater gates and 23 dams. CSO treatment facilities and in-system storage devices are installed to reduce CSO discharges. Seven in-system devices (double leaf in-system storage slide gates and associated equipment) were completed in 1998. Most of these have since been removed.

There are two CSO retention treatment basins in the district: Seven Mile and Puritan Fenkell.

Seven Mile Retention Treatment Basin: This basin is located on the east side of Shiawassee, north of Seven Mile, on the west side of the Rouge River. Completed in 1999, it is designed to capture and treat CSOs from part of 1,029 acres formerly draining to the Puritan Sanitary Pumping Station. Its

storage capacity is 2.2 mg, and it can provide treatment for up to 656 cfs of flow. The basin was designed for 1-year, 1-hour duration storm (1-inch) with 30-minutes detention. The facility contains two catenary-type bar screens and a sodium hypochlorite feed system. During dry weather, there is no flow routed to the Seven Mile Road Basin. During wet weather, the control gate at Seven Mile and Shiawassee regulates the flow to the Seven Mile Basin.

Puritan-Fenkell Retention Treatment Basin and Pumping Station: This facility is located within Eliza Howell Park east of Telegraph south of Fenkell and west of the Rouge River. Completed in 1999, the facility captures the remainder of the CSOs from the area draining to the Puritan Pump Station and provides storage for 2.8 mg of CSO and treatment for up to 845 cfs of flow. The Puritan Fenkell Basin was designed for 1-year, 1-hour duration storm (1-inch) with 20 minutes detention. The facility contains two sanitary pumps rated at 1,100 gpm each. There are three dewatering pumps each rated at 4,500 gpm.

3.3.2 Southfield Sewer District

Like the Rouge Sewer District, the Southfield Sewer District is one of the areas incorporated into Detroit between 1920 and 1926 in the city's final expansion to its present limits. The trunk sewers were built in the 1920s and 1930s. The surface contours of the area slope gently from the northeast to the southwest. The land falls approximately 60 feet in 11 miles (58,000 feet). This is an average slope of approximately 0.10 percent. The land use in the area is mostly residential, primarily single-family housing. The storm drainage for the road network is divided between the Detroit combined sewer system and a separate MDOT system for I-96, which discharges directly to the Rouge River. The district covers an area of 7,710 acres.

The construction of the sewer system in the Southfield Sewer District (when it was the eastern part of the Northwestern District) began in the 1920s. The major sewer in the area is the Southfield Sewer, located under the Southfield Freeway from Eight Mile Road to Ford Road where it joins the Hubbell Sewer just east of Mercury Drive. The Southfield Sewer is a concrete cylinder varying in diameter from 6'-9" to 12'-6". It has no remote control facilities located in the district, but it has 10 major sewers connections running in an east-west direction connecting from Hubbell to the east to Northwest Interceptor/Rouge River to the west. Several of these sewers can route excess combined flows to outfalls on the east side of the Rouge River. Major sewers for transporting excess flow west from the Southfield sewer are McNichols Relief (15'-0"); Glendale (13'-0"); Plymouth (8'-3" to 10'-6"); and Tireman (8'-3" to 10' -6").

Southfield Sewer transports flow south into the Hubbell-Southfield Combined Sewer at Ford Road. The Hubbell-Southfield Sewer extends from Ford Road south to the Rouge River. At the discharge of this sewer is located the Hubbell-Southfield Retention Treatment Basin. Upstream from this basin are remotely controlled inflatable dams (HUB1) that provide additional in-system storage and used to reduce use of the RTB for smaller events. Discharges from the district to the NWI are controlled through a regulator gate at Michigan Avenue. The upper portion of the Hubbell-Southfield Combined Sewer, from Ford Road to Michigan Avenue, is a 13'-4" x 14'-3" concrete double box. At Michigan Avenue the combined sewer changes to a 14'-6" x 12'-0" concrete double box.

The drainage from the Evergreen-Farmington Sewage Disposal District (EFSDD) in Oakland County originally went to the Southfield Sewer. Since the construction of the Evergreen-Farmington relief

sewer in 1984, this flow has been redirected to the First Hamilton sewer which flows through the northwest corner of the Conner Creek Sewer District and on into the Central Sewer District.

There are two relief sewers that serve the district. The Glendale (Schoolcraft Relief) Sewer and the Six Mile (McNichols) Relief Sewer both divert flow from the Hubbell and the Southfield Districts to the Rouge River. Other major sewers as discussed earlier can also provide relief, but generally only when higher (surcharge) conditions are achieved. There is one outfall directly from the district's sewers to the Rouge River (via the Hubbell-Southfield RTB, Outfall 101).

The Hubbell-Southfield Control Regulator (VR-8) controls the flow from the Hubbell Sewer and from the Hubbell-Southfield CSO Basin (when dewatering) into the Northwest Interceptor. The regulator, located at Michigan, has two remotely controlled 30"x 60" sluice gates. The 14'-6" x 12'-0" double box outfall contains two automatically controlled inflatable dams installed directly downstream of the regulator and upstream from the backwater gates. The outfall has a reverse slope, allowing dewatering of stored sewage through the regulator to the Oakwood-Northwest Interceptor. During dry weather, the flow is diverted to the NWI. During wet weather, the regulator is set to divert a maximum of 86 cfs to the NWI. Remaining flow is captured behind an inflatable dam up to a depth of 5 feet (elevation 98.75 feet (adaptive management operation plan for 2016)

The Hubbell-Southfield CSO Basin was completed in 1999 just upstream of the discharge point from the Hubbell Sewer to the Rouge River. This facility provides storage for 22 mg of CSOs and treatment for up to 3,200 cfs of flow. Flows enter the basin through the influent bar screens to the influent channel. There are six catenary-type bar screens in the facility. The discharges are disinfected. Currently there is outflow from the basin to the Rouge River only when the design capacity of the basin is exceeded. The basin dewateres to the Northwest Interceptor through four dewatering pumps each rated at 5,300 gpm.

3.3.3 Hubbell Sewer District

The Hubbell Sewer District is bounded on the north by Eight Mile Road, on the west by the Southfield Sewer District and on the south by Dearborn. To the east lie the Conner Creek and Baby Creek districts. The district covers an area of 6,490 acres.

This area was incorporated into the City of Detroit between 1920 and 1926 and its development was similar to the Rouge and Southfield districts. The trunk sewers were built in the 1920s and 1930s.

The Hubbell Sewer District has no dominant physical characteristic. Hubbell Avenue is the main north-south street. The Hubbell Sewer was constructed in the Hubbell Avenue right-of-way in 1927. The road is located on the western side of a shallow spur of slightly higher ground that extends out from the ridge that parallels the Detroit River and meets the river at Detroit's downtown area.

The surface contours of the area slope gently from the northeast to the southwest. The land falls approximately 55 feet in 6.5 miles (34,000 feet). This is an average slope of approximately 0.16 percent.

The land use in the area is mostly residential, primarily single-family housing. There are also some small areas of commercial and industrial activity along the I-96 corridor as it passes through the

district. Most of the freeway drainage systems discharge to the combined system. The exception is portions of the Jeffries Freeway (I-96) that extend through the Hubbell, Southfield and Rouge River districts, but the freeway drainage is separate storm water that is conveyed directly to the Rouge River

The district drains ultimately to the Northwest Interceptor. The major sewer in the district is the Hubbell Sewer, which is located in the Hubbell Avenue right-of-way from 8-Mile Road to Tireman Avenue where it turns west along Tireman and enters the Southfield Sewer District. The remaining sewers are trunk and lateral sewers, which generally run east to west along the major streets.

Hubbell Sewer is a concrete cylinder that extends south, from Eight Mile Road to Paul Road, varying in size from 8'-3" to 14'-3". At Paul Road, the Hubbell Sewer changes to a 12'-0" x 14'-3" double box that extends south to Ford Road, where it joins the Southfield Sewer and continues south as the Hubbell-Southfield Sewer. The Hubbell Sewer has no remotely controlled facilities, but it has high level relief conduits to transport excess flow in a westerly direction to the Southfield Sewer and Rouge River outfalls.

Various relief sewers were constructed in the district to relieve the Hubbell Sewer. These sewers include: the McNichols Relief Sewer (11'-3"), which runs from just east of Hubbell Avenue to the Rouge River at Six Mile Road; the Hubbell Relief Sewer, which runs along Hubbell Avenue from Curtis to McNichols and takes flow from the Curtis Sewer to the McNichols Relief Sewer; and the Glendale Relief Sewer (11'-3"), which takes flow from the Hubbell sewer to the Rouge River, and is connected to the Hubbell Sewer by high-level relief sewers directly south of Schoolcraft Road.

There are no outfalls from the district's sewers directly to the Rouge River. Any overflows to the rivers occur after flow has entered the Southfield District. There are no major regulators, CSO basins, or pump stations in the district. However, the flow from this district is discharged through the Hubbell-Southfield Interceptor, regulator, and RTB in the Southfield Sewer District.

3.3.4 Oakwood Sewer District

The Oakwood Sewer District lies on the west (southwest) side of the Rouge River. It was annexed to Detroit in 1922. It borders River Rouge, Ecorse and Melvindale and ends at West Outer Drive at the Detroit boundary with Lincoln Park.

The surface contours of the area slope very gently from the southwest to the northeast. The land falls approximately 15 feet in 2.5 miles (12,500 feet). This is an average slope of approximately 0.12 percent.

The major physical features dominating the Oakwood District are the Rouge River and the Fisher Freeway (I-75). The freeway cuts through the district along the long axis. Because of the relatively small size of district, the freeway constitutes a major portion of the district. However, while it makes a significant impact on storm flows due to its relatively large impervious area, it does not contribute to the dry weather flow. This sewer district is the smallest in Detroit, covering an area of 1,520 acres. The land use in the area is mostly residential, single-family housing, with a large industrial corridor between Oakwood Boulevard and I-75, and around the Rouge River.

The Oakwood District drains to the Northwest Interceptor, which runs along the north edge of the district before crossing under the river to join the Oakwood Interceptor on the east side of the Rouge River.

The Oakwood District is drained by two trunk sewers, the Liddesdale Sewer and the Sanders Sewer, which transport flow to Oakwood Pumping Station. The Liddesdale Sewer begins at Gleason Road as a 5'-6" diameter concrete cylinder and runs in a northeasterly direction, increasing to a 9'-0" diameter cylinder at Pleasant Street, where it turns right into a 13'-0" diameter cylinder and enters the Oakwood Pumping Station. The Liddesdale Sewer has no remotely controlled facilities. Sewers on Schaefer Highway drain to the Liddesdale Sewer.

The Sanders Sewer is a 6'-9" diameter sewer that runs in a southerly direction, increasing in size to a 10'-0" diameter cylinder at the Oakwood Pumping Station. Oakwood Pumping Station lifts flow into the Northwest Interceptor at Fort Street west of the Rouge River. Excess combined flows are discharged to the Rouge River after being treated in the RTB. There are a number of smaller sewers on Sanders Street, Mellon Street, and West Fort Street that drain the area north and west of the Fisher Freeway to the Oakwood Pumping Station.

Oakwood Pumping Station and RTB is located at 12082 Pleasant Avenue, about a mile and a half northwest of the Detroit Wastewater Treatment Plant. During dry weather, flow into the station is primarily domestic and industrial wastewater. The station has 4 sanitary pumps rated at 10 cfs. This wastewater is pumped by the sanitary pumps through a 36-inch force main to the Northwest Interceptor, which flows to the WWTP. One sanitary pump normally will maintain a low level in the wet well.

The station has 8 storm pumps, 2 rated at 150 cfs and 6 at 275 cfs. During heavy rains when the storage capacity is exceeded, the storm water pumps discharge combined sewage to the screening facility and then into two 4.5 MG CSO basins. When full, the basins overflow into the O'Brien Drain which transports these flows to the Rouge River. Due to the industrial character of the district, the potential exists for accumulation of waste oil in the wet well. An oil skimmer at the station helps with this problem. Removed skimmed oil is stored in an underground waste oil storage tank.

There are three outfalls in the district along the Rouge River, and four backwater gates.

3.3.5 Baby Creek Sewer District

Baby Creek Sewer District covers the north central part of the Detroit. Most of Highland Park is in this district as well as a small portion of southeast Dearborn. The surface contours of the area slope gently from the north to the south. The land falls approximately 80 feet in eight miles (40,000 feet). This is an average slope of approximately 0.20 percent. The trunk sewers were built in the 1920s and 1930s. The area of the district is 11,760 acres.

Baby Creek District drains primarily into the Baby Creek Enclosure which outfalls to the Rouge River at the city's border with Dearborn (B-57). A screening and disinfection facility (SDF) was constructed in 2005-2007 in George Patton Park approximately 5,400 feet mile upstream from the outfall. The downstream reach with a volume of approximately 30 MG is now used for contact time during wet weather events. After an event, the enclosure dewateres to the Oakwood Interceptor through a remotely controlled regulator (VR-7). Dry weather flow is diverted at the facility into a

Toward Treatment sewer, which discharges directly into the Oakwood Interceptor. The facility can control and treat discharges up to 1,500 cfs from the Baby Creek Enclosure.

The First-Hamilton Relief Sewer also lies partly within the district and carries part of the flow under high flow conditions to the North Interceptor-East Arm (NIEA) and to the DRI if the capacity of the connection to the NIEA is exceeded. There is a high level relief connection from the Edison Sewer, an 11'-6" diameter concrete cylinder, to the First-Hamilton Sewer at the intersection of Edison Street and First-Hamilton Avenue.

Some major sewers in the Baby Creek District are:

- Baby Creek Enclosure (14'-6" x 17'-6") extends approximately three miles from Kirkwood Road south/southwest to the Rouge River.
- Lonyo Sewer (14'-0" x 14'-6") begins at Kirkwood Road and connects into the Baby Creek Enclosure at Dix Road.
- Elmer Ternes Sewer (14'-0" x 14'-6") parallels the Lonyo Sewer.
- Wyoming Sewer a (5'3" diameter to 11'-6") cylinder runs from Puritan to Warren where it joins the Weatherby sewer.
- Wyoming Relief Sewer (7'-0" to 15'-0") is a concrete cylinder connecting into the Lonyo sewer, south of the Weatherby Sewer through relief port type connections.
- Weatherby Sewer (17'-9" x 13'-5") transports dry weather and some storm flows from the junction structure of the Livernois, Upper Livernois Relief and Joy sewers at Joy Road to the Lonyo Sewer at the intersection of Lonyo Road and Kirkwood Road.
- Joy and Edison Sewer (also called Weatherby Arm) 17'-9" x 13'-5" transports dry weather and some storm flows from the junction structure of the Livernois, Upper Livernois Relief and Joy sewers at Joy Road to the Lonyo Sewer at Lonyo Road and Kirkwood Road.
- Livernois Sewer (5'-0" to 9'-0") is a concrete cylinder running primarily north-south, transporting combined flows from Puritan Road to Joy Road.
- Upper Livernois Relief Sewer (6'-0" to 11'-6") is a concrete cylinder running parallel with the Livernois Sewer.
- Linwood Sewer (9'6") follows Linwood Street at a 0.12 percent slope.
- Livernois Relief Sewer (19'-6") extends from Joy Road to Jefferson Avenue.
- First-Hamilton Relief Sewer (4'-0" to 15'-6") transports flow from the Evergreen-Farmington District to the North-Interceptor-East Arm and the Detroit River Interceptor.

Woodmere Pumping Station is located in George Patton Park between Dix Avenue and Vernor, directly adjacent to the Baby Creek SDF. The station pumps mostly storm flows but also discharges

some sanitary flows to the Baby Creek facility. There are three storm pumps each rated at 256 cfs (165.5 mgd), and two sanitary pumps each rated at 8 cfs (5.2 mgd).

There are two backwater gates and one outfall in the district.

3.3.6 Conner Creek Sewer District

This sewer district is located on the north-central area of Detroit. Small portions of Highland Park and Hamtramck are in this district. The surface contours of the area slope gently from west to east across the northcentral part of Detroit before sloping to southeast, terminating at the East Jefferson District. The land falls approximately 55 feet in 12 miles (60,000 feet). This is an average slope of approximately 0.09 percent.

Major suburban flows enter the district from the north: The Evergreen-Farmington Sewage Disposal District flow and the Southeast Oakland Sewer District flow. Both are carried to the North Interceptor East Arm by relief sewers. The district covers an area of 17,360 acres, making it the city's second largest sewer district.

The major sewers in the district are:

- Conner Creek Sewer (Enclosure) varies from an 8'-0" diameter sewer to an 18'-6" x 21'-9" concrete triple box outfall. The district primarily drains into this sewer, which also transports flow from Centerline. It flows in a general north to south direction and discharges through the Conner Creek Control Regulator into the DRI or, during wet weather events, through the Conner Creek RTB where it is screened and disinfected before being discharged to the Detroit River. The Conner Creek RTB is further discussed as part of the East Jefferson district descriptions.
- Seven Mile Sewer (11'-6" diameter) follows Seven Mile from Conner Creek Sewer to the Rouge River, with a high point at Meyer Road defining the border of the district with the Hubbell District.
- Seven Mile Relief Sewer (13'-0" to 9'0") runs in an east-west direction between Conner Creek Sewer and Conant-Mt. Elliott Relief Sewer.
- McNichols (Six Mile) Sewer (5'-6" to 10'-6") combined sewer follows Six Mile from Rouge River to Conner Creek, also with a high point at Meyer Road defining the border of the district with the Hubbell District.
- Conant-Mt. Elliott Relief Sewer (9'-0" to 16'-3") receives metered suburban flows from the Dequindre Interceptor (SE Oakland District) which enters the sewer by gravity at Emery Road. The flows are then conveyed to the North Interceptor-East Arm. During wet weather, the excess wet weather flows are conveyed to the Leib SDF.
- First-Hamilton Relief Sewer (4' to 15'-6") transports flow from the Evergreen-Farmington District to North-Interceptor-East Arm, with excess flows continuing to the Detroit River Interceptor and potentially overflowing to the Detroit River.

- North Interceptor – East Arm (12'-0"-17'-6") is one of the three major GLWA Interceptors. It is an 86,800-foot reinforced concrete sewer has a capacity range of 341-454 cfs.
- Lynch Road Sewer (4'-0"- 11'-6") is a combined concrete cylinder sewer providing routing for wet weather flow from the Conant-Mt. Elliott Sewer and potentially a portion of Highland to the Conner Creek district.

The East Jefferson and Conner Creek districts contain two remotely controlled facilities, the Connor Creek Flushing Gates at Warren and the Conner Creek Control Regulator (control gates) south of East Jefferson. The flushing gates are located where the Conner Creek enclosure transitions from 2 barrels to 3 barrels. The gates originally consisted of three 10'-0" x 7'-0" roller gates, but these have been removed and stop-logs are now placed in 2 of the 3 barrels to increase dry weather flows and reduce issue of sedimentation. The control regulator has a 48-inch knife gate of sufficient capacity to allow normal dry weather flow into the Detroit River Interceptor and two additional 60" x 72" sluice gates for remotely controlled operation.

The Northeast Pump Station is physically located in the district, but operationally is part of the Oakland-Macomb Drain Drainage District; its operation is discussed there.

3.3.7 Central Sewer District

This sewer district lies at the center of Detroit and includes the area of the original city settlement. Its most important physical feature is the Detroit River. The construction of the sewer system in the district began in the mid-1800s. All of the major sewers in the district run to the Detroit River, where they originally discharged directly to the river.

The surface contours of the area slope gently from the northwest to the southeast. The land falls approximately 36 feet in 8.5 miles (43,000 feet). This is an average slope of approximately 0.08 percent, a very flat gradient. The area of the district is 22,490 acres, making it the largest in the city.

The Central Sewer District receives flows from all the other districts. The Detroit River Interceptor and the North Interceptor East Arm are the major interceptors in the district. Other major sewers transporting suburban flow through the district are the First-Hamilton Relief Sewer and the Conant-Mt. Elliot Sewer. Both are connected to the North Interceptor-East Arm and the Detroit River Interceptor, and both can overflow during wet weather events to the Detroit River. A large number of north-south trunk sewers discharge to the DRI with potential to discharge excess flows to the Detroit River in response to wet weather. Some important trunk sewers include the Central, Clark, Third Street, Brush and Joseph Campau sewers.

Thirteen of the 20 valve remote gates operated by GLWA are located in the Central Sewer District. Eight of these control flows into the DRI, four control flow transfers between 2 sewers in the system, and one is use for maintenance. These are briefly identified as follows:

The eight gates controlling flows into the DRI include the regulators located at Dearborn, Livernois, Conant-Mt. Elliot (Leib SDF), First Hamilton (First St.), St. Aubin, DuBois, Chene, and McClellan-Cadillac.

The four gates controlling flow transfers include the Joy Control Gate, which allows flows to move from Joy-Weatherby sewer (Baby Creek district) to the Livernois Relief (Central district), and 3 gates controlling flows into the NIEA from First Hamilton, Conant-Mt. Elliot and Meldrum.

The one gate for controlling flow for sewer maintenance is the Warren Control Gate (VR-11), located in the Livernois Relief sewer at Warren.

The Central Sewer District has a large proportion of the outfalls, backwater gates, regulators, and dams in the GLWA service area. There are 37 untreated and 3 treated outfalls from the district's sewers to the Detroit River, 4 untreated outfalls to the Rouge River, 24 backwater gates, 40 regulators, eight other regulators and 31 dams.

There are five major pump stations:

- The Detroit WRRF has two large pump stations at the plant. The older PS-1 is currently capable of pumping up to 2,234 cfs (1,444 million gallons per day). The newer PS-2 provides an additional 1,423 cfs (920 mgd) of capacity.
- Fairview Sanitary Pump Station, constructed in 1910, is a lift station for the Detroit River Interceptor located near East Jefferson. In 1974 its capacity was increased to 336 mgd. It contains three sanitary pumps each rated at 150 cfs (97 mgd), one sanitary pump rated at 75.8 cfs (49 mgd), and a dewatering pump rated at 1.5 cfs (1 mgd).
- Fischer Pumping Station is located in Erma Henderson Park and handles flows only from Detroit. It is being operated by GLWA, but not leased. It contains two sanitary pumps rated at 10.5 cfs (6.8 mgd) each. Wastewater is pumped from the Fischer Relief Sewer into the Detroit River Interceptor. During dry weather, it can handle all incoming flow from the relief sewer. During storm conditions, when the DRI flow level is too high and cannot accept additional flow, the pump is shut down, resulting in overflows to the Detroit River.
- Belle Isle Pump Station consists of seven packaged pumping stations and a main pumping station to handle flows generated on the island. The station is being operated by GLWA, but not leased as the flows are Detroit flows only. The main station had a 0.19 MG storage tank for excess flows, but the station was converted to a Retention Treatment Basin, which began operation in 2008. The packaged stations primarily pump sewage to the main station. At the main station two sanitary pumps rated at 3 cfs (2 mgd) each move wastewater across the Detroit River to the Detroit River Interceptor (DRI) through a 12-inch force main. When excessive storm flow is received at the main pumping station, three storm pumps rated at 17 cfs (11 mgd) each are used to pump the excess flow to the 0.3 MG basin, where it is held until flow decreases. If the basin is exceeded, the overflow goes directly to the Detroit River.

The district includes two screening and disinfection facilities (SDFs), Leib and St. Aubin. The Leib facility design flow is 1,550 cfs, but it can hydraulically pass up to 2,000 cfs in case of extreme conditions. The St. Aubin facility will screen and disinfect up to 250 cfs of wet weather flows before discharging to the DRI or the Detroit River. Both facilities began operation in 2002, with final completion reached in 2004 for St. Aubin and 2005 for Leib.

3.3.8 Fox Creek Sewer District

The Fox Creek Sewer District encompasses the eastern portion of Detroit, bounded by the Conner Creek district to the west, 8-Mile Road and Harper Woods to the north, the various Pointes to the east and south. The surface contours of the area generally slope from north/northwest to south/southeast. The land surface falls approximately 50 feet in seven miles (37,000 feet). This is an average slope of approximately 0.14 percent, a flat gradient. Land use is a mixture of residential and commercial. The area of the district is 8,420 acres.

The district sewer system is laid out at right angles to the Fox Creek Enclosure, the outlet the system originally drained to. Although most sewers in the district are combined, there is a 2.4 square-mile area of separated sewers. Sanitary flow is conveyed by gravity to the DRI, while the storm water flow from this area is drained through the deeper combined sewers to the Jefferson Avenue East Relief Sewer. Relief sewers were completed after these major sewers were constructed.

The Fox Creek district drains sanitary and storm flow into the East Jefferson District through the Mack Avenue Relief Sewer, Fox Creek Relief Sewer, Ashland Relief, and Fox Creek Enclosure.

Mack Avenue Relief Sewer (8'-6" to 16'-0" diameter) begins at the Bluehill Pumping Station, extends to Manistique and turns south following Manistique to the Jefferson Avenue East relief sewer.

Fox Creek Relief Sewer (10'-6" to 14'-6") located in Grosse Pointe Park, also begins at the Bluehill Pumping Station. Flow is transported down the 16'-0" Manistique Sewer to the Jefferson Avenue East Relief Sewer.

Ashland Relief (13'-9" to 16'-0") traverses the whole of the district, beginning north of Seven Mile as Puren Relief and terminating at the Freud pump station, with any dry weather flows diverted to Jefferson Avenue East Relief Sewer upstream of the pump station.

Fox Creek Enclosure (11'-7" x 15'-0" to 16'-0"), located in Grosse Pointe Park, begins at Grosse Pointe Farms pumping station at Kerby Road and directs flows into the Fox Creek backwater gate structure where it continues either into the Jefferson Avenue East Relief Sewer or to Fox Creek open channel.

Excess combined flows from these sewers are routed to the Conner Creek Pumping Station and/or to the Freud Pumping Station. Interconnections exists such that essentially either pump station can be used for smaller storm flows.

Combined sewers, such as Ashland, Bedford, Three Mile Road, Cadieux and Rivard sewers, transport flow from within the Fox Creek District to the major sewers listed above.

Fox Creek Backwater Gate structure transfers flow from the Fox Creek Enclosure into the Jefferson Avenue East Relief Sewer via three manually operated sluice gates. It is located in the East Jefferson District, but handles flows from the Fox Creek District. Excess combined flow may also be routed through this structure to the Fox Creek open channel. The structure contains a gate downstream of the backwater gates which can be opened to allow for flushing the Fox Creek open channel into the Jefferson Avenue East Relief Sewer.

Bluehill Pump Station is the only pump station in the district. It is not leased by GLWA as it only pumps Detroit flows, but it is being operated by GLWA. It is located at 17145 Mack, between Cadieux and Moross. There are two separate stations: a sanitary pumping station serving a 3.7 square-mile area north of the station for dry weather flows and a storm water pumping station for wet weather flows. The station contains two sanitary pumps rated at 10 cfs (6.5 mgd) each and four storm pumps, three rated at 390 cfs (252 mgd) and one rated at 177 cfs (114 mgd). The station receives combined wastewater flow into its sanitary and storm water pumping station wet wells through the 11'-9" diameter Rivard Sewer. During dry weather flow periods, flow is pumped to the 10'-6" diameter Fox Creek Relief Sewer. During storm weather, combined wastewater is pumped by the storm pumps through a control chamber into the Fox Creek Relief Sewer. Under high storm flow conditions, a control chamber diverts excess flow into the Mack Avenue Relief Sewer.

3.3.9 East Jefferson Sewer District

The East Jefferson Sewer District is located downstream of the Conner Creek and the Fox Creek sewer districts. The Detroit River lies at the south limit of the district and is the point of discharge for the CSOs from the district. The surface contours of the area slope gently from the northwest to the southeast. The land falls approximately 10 feet in one mile (5,000 feet) for an average slope of approximately 0.20 percent, a flat gradient. The East Jefferson Sewer District is the second-smallest district in Detroit at 2,810 acres.

Several major trunk sewers and relief sewers transport combined flows from the Fox Creek District and surrounding suburbs, primarily to the Jefferson Avenue East Relief Sewer. Dry weather and excess combined flows flow through the DRI west along Jefferson Avenue from the westerly city limits of Grosse Pointe Park.

The East Jefferson District also receives dry weather flow and combined flow from the Conner Creek District. Flow is transported from the Conner Creek Enclosure by gravity to the DRI through a 7'-0" diameter cylinder. Excess combined sewage overflows through the Conner Creek backwater gate structure to the Detroit River through the Conner Creek retention treatment basin (RTB).

The district includes a diked area on the east side of Detroit of several hundred acres where the ground level is lower than the water level in the Detroit River.

The district contains three pump stations:

Conner Creek Pumping Station is located at 12244 East Jefferson at Clairpointe. It receives both sanitary and storm flows from two 14-foot diameter sewers, the Jefferson Avenue East and West relief sewers. This large pumping station contains eight storm pumps each rated at 492 cfs (318 mgd), two sanitary pumps each rated at 110 cfs (71.1 mgd), one sanitary pump rated at 75 cfs (48.5 mgd) and one sanitary pump rated at 40 cfs (26 mgd).

During dry weather conditions, sanitary flow is pumped to the Detroit River Interceptor (DRI). During storm conditions, flows that cannot be pumped into the DRI are discharged to the Conner Creek RTB, which discharges to the Detroit River. The station is currently under study for potential renovation or replacement.

Freud Pumping Station is located at 12300 Freud, between Tennessee and Clairpointe, south of Jefferson. It has eight storm pumps each rated at 449 cfs (290.2 mgd), one sanitary pump rated at 35.1 cfs (22.7 mgd) and one sanitary pump rated at 20.1 cfs (13 mgd).

The Freud station receives wastewater flow through the 16-foot diameter Fox Creek and Ashland relief sewers.

Because the Freud Pumping Station is primarily a storm pumping station, very little dry weather flow is received. During storm flows, the sanitary pumps are not operated. At high wet well levels, storm water pumps discharge to the Conner Creek RTB. When the Conner Creek Pump Station capacity is exceeded, storm water overflows into the Fox Creek and Ashland relief sewers that discharge to the Freud Pumping Station.

Conner Creek RTB began construction in 2001 and was in operation by 2005. The basin will collect CSOs from the Conner Creek Pump Station, Freud Pump Station, and Conner Creek Enclosure. The basin is located at the head of Conner Creek. The facility was designed to provide treatment through bar screens to remove floatables and sodium hypochlorite disinfection with a five-minute contact time. The capacity of the basin is 30 MG, based on the 10-year one-hour storm peak flow of 13,262 cfs. There are four compartments in the facility, with the ability to decant. The basin dewateres to the DRI and is controlled by the level in the DRI.

3.3.10 City of Highland Park

The City of Highland Park lies to the north of downtown Detroit along Woodward Avenue. It is bounded by Tuxedo and Tennyson streets on the south and McNichols Road on the north.

The city covers an area of 1,894 acres (2.96 square miles). Land use in the city is 49 percent residential; 26 percent commercial, institutional, and office; 11 percent industrial; and 14 percent is transportation, utilities, recreation, and other uses. The housing stock was largely built in the 1920s, with many large brick art-and-crafts style houses originally built by auto company foremen.

Highland Park's sewer system was constructed beginning in the 1890s as an outlet became available in the Detroit system. Highland Park was incorporated in 1917 and was originally on the edge of Detroit. It was surrounded by Detroit when Detroit annexed the area up to Eight Mile Road in the mid-1920s. The municipality made an agreement with Detroit to discharge sewage into Detroit's sewer system in 1898. A new agreement, signed in 1940 when the WWTP was constructed, provided for the community to pay for the treatment of its wastewater as well as conveyance. Contractual agreements between Highland Park and GLWA allow the city to discharge up to a 10-year peak flow.

Highland Park was heavily industrialized for many decades, with both Ford and Chrysler automobile plants located there. Ford closed its Highland Park plant in 1971, and Chrysler left the city in 1996. More recently, despite some new commercial and residential developments, the city's industrial base has continued to decline. The city's financial problems, resulted in the appointment of a state emergency financial director in 2001.

The Highland Park sewer system is so interconnected with the Detroit system that it is effectively an integral part of that system, with portions of the city falling within the Baby Creek and Conner Creek sewer districts.

The sewer system in Highland Park was primarily constructed between 1920 and 1950. The entire system is combined. The city's sewers are interconnected with the City of Detroit sewers, so none of Highland Park's discharges are metered separately.

Inspection of the system conducted for the 1982 City of Highland Park SSES Study showed that there was excessive infiltration in some areas of the city. Many manholes showed signs of deterioration. Numerous sewers contained appreciable sediment deposits.

Major interceptors and trunk sewers in Highland Park include the McNichols Sewer, the Woodward Sewer, and the First-Hamilton Relief Sewer. The First-Hamilton Relief Sewer was designed to include wet weather capacity for Highland Park.

These sewers are more fully described in the sections on the Connor Creek and Baby Creek districts provided earlier in this chapter.

There are no pump stations, control structures, CSO outfalls or CSO basins in Highland Park.

3.3.11 City of Hamtramck

The City of Hamtramck lies to the north of downtown Detroit between Carpenter (north boundary) and Newton (south boundary). The western boundary is Lumpkin and the Grand Trunk Western railway and the eastern is Conant and Vincent. Most of Hamtramck lies in the Central Sewer District, with a small northeast portion tributary to Conner Creek.

The city covers an area of 1,337 acres (2.09 square miles). Land use in the city is 53 percent residential; 16 percent commercial, institutional, and office; 19 percent industrial; and 12 percent transportation, utilities, recreation, and other uses. The housing stock is largely wooden single-family homes, built in the 1920s by Polish and German immigrants.

The City of Hamtramck was incorporated in 1922. It was originally on the edge of Detroit but was surrounded when Detroit annexed up to Eight Mile Road in the mid-1920s. Hamtramck was formerly a center of industry and had a peak population of approximately 90,000 in 1930. Since then, industrial activity and population have declined. The Dodge Main Plant, which at one time employed 25,000 people, closed in 1980. The city is currently undergoing financial problems and the State of Michigan has appointed a financial controller to attempt to resolve these problems. Commercial activity in the city has increased in recent years.

Hamtramck's sewer system was constructed in the 1920s as an outlet became available in the Detroit system. The Hamtramck sewer system is so interconnected with the Detroit system that it is an integral part of that system.

Hamtramck originally made an agreement with Detroit to discharge sewage into Detroit's system in 1928. This agreement included capital and operating charges for past use of Detroit sewers, but the agreement may have expired in 1963. The current agreement came into force in 1942. A contract for indefinite service was signed in August 1941, and states that the charge for sewer service will be

based on the water consumption, at the rate of \$0.2162 per thousand cubic feet of water delivered. A 1989 settlement requires Hamtramck to pay back arrearages for these sewer service payments.

The contracts between Hamtramck and GLWA allow for acceptance of peak flows up to 1,244.5 cfs. A total conveyance capacity of 337.5 cfs was purchased by Hamtramck, with an additional 907 cfs for a 10-year storm provided in the design of the Conant-Mt. Elliott relief sewer.

The entire system is combined and is reported to be adequate to convey the sanitary flows from the city but not adequate to carry the flow from a 10-year storm or greater. The sewer system is interconnected with the Detroit system and there are no meters installed to measure flow.

Main sewers in the city are the Joseph Campau Sewer and the Conant-Mt. Elliott Relief Sewer. The relief sewer was designed to provide wet weather capacity for Hamtramck.

These sewers are more fully described in earlier sections on the Central and Connor Creek districts.

There are no pump stations, control structures, CSO outfalls or CSO basins in Hamtramck.

3.3.12 Rouge Valley Sewage Disposal District

The Rouge Valley Sewage Disposal District (RVSDD) serves most of western Wayne County and a small portion of Oakland County. Except for the Oakland County portion, the district is administered by the Wayne County Department of the Environment. The district also accepts wastewater from the Western Townships Utility Authority (WTUA), though beginning July 1, 2017, the effective contribution is zero. The first agreement between GLWA and Wayne County to serve the communities within the North Huron Valley-Rouge Valley (NHV-RV) district was signed in 1953. It was subsequently amended several times to update requirements for wastewater service. The district covers 274 square miles, an estimated 55 percent of which is sewered. The peak flow allowed for discharge from NHV-RV sewers into the Detroit sewer system was 380 cfs (245.6 mgd), but that was subsequently increased to 423 cfs (273 mgd) through an amendment to the wastewater service agreement.

Combined sewer areas in the district are primarily limited to the eastern portion of the district in the oldest communities such as Garden City, Inkster and Livonia. Even in these cities, most of the sewers are separated. The Middle Rouge subdistrict is served by the Upper Rouge and Middle Rouge interceptors, which combine with Detroit's Northwest Interceptor at Evergreen and Ford Road (technically, the NWI joins the WC interceptor, as the interceptor reach from Evergreen to Southfield is owned by WC). The Lower Rouge subdistrict is served by an interceptor system that parallels the lower branches of the Rouge River. This interceptor system crosses under the Rouge River at Fort Street and discharges into the Oakwood section of the Northwest Interceptor.

Lift Station 1A, operated by Wayne County, has the capacity to pump from the Middle Rouge Interceptor to the Northwest Interceptor under surcharged conditions. The capacity of the pump station is 250 cfs (164 mgd).

There are several CSO and wet weather flow basins in the district:

Redford Township CSO Retention Basin is located in Redford Township at the intersection of Lola Drive and Puritan Avenue. The facility contains a two-compartment basin of 1.7 million gallons,

three catenary-type bar screens, two swirl concentrators, and sodium hypochlorite disinfection sized to treat 180 cfs with a retention time of 20 minutes. The pump station capacity is 16,200 gpm. Overflow from the basin enters the upper Rouge River.

Inkster CSO Retention Basin is owned by the City of Inkster and located on Inkster Road north of Michigan Avenue. The basin serves an area of 833 acres, has a volume of 3.0 MG and was sized based on the 1-year 1-hour design storm with a peak flow of 500 cfs and 20 minutes of detention. It has six constant speed pumps at 45,000 gpm at 30 feet TDH.

Dearborn Heights CSO Retention Basin is owned by Dearborn Heights and is located within the Middle Rouge Parkway. It has eliminated four CSO outfalls. The basin serves an area of 340 acres with volume of 2.7 MG. It was sized for the 10-year 1-hour design storm with a peak flow of 500 cfs and 30 minutes of detention. The basin has six vertical mixed flow pumps each having a pump capacity of 45,000 gpm at 28 feet TDH.

Wayne Equalization Basin, located in Wayne, has a volume of 2.3 MG. It serves an area of 2,849 acres.

Livonia Equalization Basin, located in Livonia, has a volume of 2.2 mg and was sized for the 10-year 6-hour storm. It serves an area of 11,678 acres.

In addition, there are two basins in the district operated by the Western Townships Utilities Authority. The influent is pumped and effluent flows by gravity.

Middle Rouge Equalization Basin: Volume 7.8 MG.

Lower Rouge Equalization Basin: Volume 5.5 MG.

There are 48 regulators in the district nearly all of which are associated with outfalls along the Rouge River and its branches.

3.3.13 Former Northeast Sewage Disposal System

The Northeast Sewage Disposal System (NESDS), formerly known as the Northeast Wayne County Sewer District (NEWCSO), consists of the communities of Harper Woods, Grosse Pointe Woods and Grosse Pointe Shores. The district covers all of these communities except a small portion of Harper Woods between Roscommon Street and the Detroit boundary. The Milk River Intercounty Drain Drainage District (MRIDDD), formerly the Milk River Drainage District, is located in the NESDS. This district was formed by Harper Woods and Grosse Pointe Woods, communities discharging to the Milk River.

Wayne County entered into an agreement with GLWA (DWSD) in 1944 to discharge its wastewater into GLWA's sewer system. The agreement was subsequently amended in 1957 and 1961. NESDS has a contract peak discharge of 82.1 mgd (127 cfs) to the GLWA sewer system. This maximum discharge includes the flow from the upstream Southeast Macomb Sanitary District (SEMSD), which had a contract with Wayne County Department of Public Works for sewage disposal service. In 2018, Wayne County transferred the ownership and operation of the NESDS to the SEMSD.

The SEMSD operates the facilities in both districts (NESDS and MRIDDD) from offices located at the Milk River facility. The Northeast Sewage Disposal System Board and the Milk River Drainage Board are the decision-making entities that administer each district.

The district covers 7.63 square miles. Land use is more than three-quarters residential.

Grosse Pointe Shores is the oldest community in the district and has both combined and separated sewers. Most of its sewers were constructed between 1949 and 1975, with the largest proportion constructed in the 1950s. Grosse Pointe Woods has combined sewers, as much of the system was constructed before 1929. Harper Woods has separated sewers. A small portion of Harper Woods is part of the Detroit system.

The Grosse Pointe Woods and Harper Woods sewer systems discharge to the Grosse Pointe Interceptor (GPI) through the Milk River System. Formed in the 1950s with the construction of the Milk River Pumping Station, the Milk River System is operated by the Milk River Intercounty Drain Drainage District Board and includes the pumping station, a retention basin, and a recirculating pump station at the end of the Milk River on Lake Shore Drive. Overflows from the basin discharge to the Milk River.

Marter Road Booster Station boosts the flow from SEMSD into the GPI during wet weather to the maximum allowed by the GLWA contract (102cfs). This pump station has three pumps each rated at 36 mgd (55 cfs).

Milk River Pumping Station contains three pumps rated at 5,000 gpm (7.2 mgd, 11 cfs). During dry weather, it collects and lifts dry weather flows for discharge to the GP Interceptor. During storms, the pumping station discharges flow in excess of 22 cfs to the 18.5 MG Milk River Retention Basin. The Milk River Recirculation Station contains two pumps rated at 10,000 gpm (14.4 mgd, 22 cfs).

Torrey Road Pumping Station, operated by Grosse Pointe Woods, pumps sanitary flows from Grosse Pointe [Harper??] Woods to the Milk River Retention Basin. It has two pumps rated at 2,600 gpm (3.7 mgd, 5.7 cfs) and one pump rated at 20,000 gpm (28.8 mgd, 43.9 cfs).

Cook Road Pumping Station, operated by Grosse Pointe Shores, has two sanitary and two storm pumps that pump flow from Grosse Pointe Shores to the GP Interceptor. Maximum installed capacity is controlled at 2 mgd (3 cfs) to meet contract limitations. There are four outfalls from the Lake Shore Interceptor to Lake St. Clair that overflow when the pumping capacity of the Cook Road Pumping Station is exceeded.

Kerby Road Pumping Station, 127 cfs capacity, is the major discharge point for NEWCSD. The station, located in Grosse Pointe Farms, contains five pumps each rated at 14,200 gpm (20.4 mgd, 31 cfs).

The entire flow from the NESDS and the SEMSD is lifted to the Fox Creek Enclosure by the Kerby Road Pumping Station. The flow from the Fox Creek Enclosure enters the Detroit River Interceptor via the East Jefferson Relief sewer and Conner Creek pump station. Where the enclosure terminates and flows into the East Jefferson Relief sewer, an outfall exists (B1), but it is no longer a permitted discharge point, being reserved for emergency condition/discharge only.

3.3.14 City of Dearborn

Dearborn is directly south and west of the City of Detroit and is also located at the terminus of the Wayne County interceptor system. It is therefore the location of many important facilities in both systems. To the west of the city is the Rouge Valley Sewage Disposal District. To the south are the Cities of Allen Park, Melvindale, and Taylor.

The city is traversed by the Rouge River and the Lower Rouge River, which lie in the floors of shallow valleys. The ground slopes generally from northwest to southeast, although the topography is very flat, the result of a glacial lake plain formation.

Of the 15,615 acres in the city, approximately 30 percent of land use is residential, 10 percent is commercial, 16 percent industrial, 12 percent institutional, and the remaining 32 percent public rights-of-way, flood-control facilities, and vacant land. The large component of non-residential land use is due to the location of major companies and institutions such as Ford Motor Company, Greenfield Village, Henry Ford Community College, and the University of Michigan-Dearborn campus. The city's major roads include I-94, Michigan Avenue, Ford Road, Telegraph Road, and the Southfield Freeway.

Agreements for sewage flow were reached between Detroit and Dearborn in 1957, 1960 and 1961. Through these agreements, 64.6 mgd (100 cfs) represents the 1998 peak flow allowed for discharge from the Dearborn sewers into the Detroit sewer system. Billing for the City of Dearborn is divided into separate charges for Dearborn East, Dearborn East (storm), Dearborn West, and Dearborn Northeast.

Dearborn's collection system has a total of 456 miles of sewer, most of it constructed before 1940. The existing sewer system is mostly combined - 12,325 acres of combined sewer area and 934 acres of separated sewer area.

There are five sewer districts in the city: East Dearborn, West Dearborn, Northwest Interceptor District, Hubbell Creek District, and Baby Creek District. The last two have traditionally been considered as part of their bordering districts in Detroit.

About 1,500 acres of Dearborn in the northeastern part of the city are in the drainage area of the Baby Creek District and are unmetered. In addition, some storm flows are unmetered and enter the Detroit combined system along portions of southeast Dearborn that borders Baby Creek Enclosure. The majority of the rest of Dearborn's sewage is metered at two points associated with the two pump stations in the city. These meters are located at the intersection of Miller Road and Dearborn Avenue and at the intersection of Greenfield Avenue and Butler Street. Additional meters measure very small flows at other connections of commercial and office parks.

As of 1980 there were 21 combined sewer overflows, including overflows at diversion chambers overflows at overflow manholes and emergency overflows at the pumping stations. Eighteen diversion structures regulate flow of wastewater into the interceptor system.

To address overflows to the Rouge River, construction of a storage tunnel was initially pursued. The original plan for the Dearborn Tunnel consisted of two phases. The final design for Phase I of the tunnel was completed in 1994 and construction on the tunnel began in 1995. This initial design of

the Dearborn Tunnel consisted of an approximately 31,000-ft long 18-ft diameter tunnel totaling 65 MG of storage volume. Due to heavy groundwater inflows encountered during construction of the Phase I tunnel, construction was halted. Since the halt of construction, Dearborn has re-evaluated CSO facility alternatives and has pursued use of in-ground storage shafts and sewer separation to address CSO flows.

GLWA-leased wastewater facilities located partially or wholly in Dearborn include the Hubbell-Southfield CSO Basin, the Baby Creek CSO Basin and several meters.

There are two pump stations in Dearborn that discharge the majority of the city's sewage to the GLWA system. These pump stations were converted from wastewater plants that were formerly located at these sites.

Greenfield Road Pumping Station has five submersible pumps, with a total station capacity of 68 cfs (44 mgd).

Miller Road Pumping Station has one pump, providing a firm capacity of 20 cfs (13 mgd).

3.3.15 City of Allen Park Sewer System

Allen Park was incorporated in 1957 and covers an area of 4,524 acres or 7.1 square miles. Of this, approximately 1,696 acres, or 2.6 square miles, are served by the Great Lake Water Authority. Allen Park is bounded on the north and west by Dearborn and Dearborn Heights, on the east by Melvindale and Lincoln Park, and on the south by Taylor and Southgate (24).

The northern third of Allen Park is served by GLWA. It is primarily an industrial area with about 1,000 single-family residences and 500 multi-family units. The southern two-thirds of the city is served by the Wyandotte Wastewater Treatment Plant through a contract with the Wayne County Department of Public Works.

Land use in the city is 51 percent residential, 17 percent commercial, institutional, and office, 11 percent industrial and extractive, and the remaining 21 percent transportation, recreation, and other uses (SEMCOG, 1995). The housing stock was predominantly built during the 1950s and 1960s.

There are three industrial parks in Allen Park. Large industrial companies in the area include Frito-Lay, Inc., Ford Motor Company, and Heublen, Inc. Frito-Lay closed their plant in 2004, reducing Allen Park's baseflow by 2 cfs, about a quarter of their average flow. A major new commercial development was initiated in 2006. Called Fairlane Green, it consists of a one-million-square-foot retail/recreational center with parks and trails on a 243-acre closed Allen Park Clay Mine Landfill. Major roads through Allen Park include the Southfield Freeway, I-94 (Ford Freeway), and Oakwood Boulevard.

Three agreements for sewage disposal were established between Detroit and Allen Park in April 1955, July and August 1959 and June 1974. The peak flow allowed for discharge from Allen Park sewers into the Detroit sewer system is 0.4 cfs per 1,000 persons based on population and the "Industrial Hydraulic Equivalent." The current accepted discharge limit is 10.6 cfs. Occasional excess wet weather flows in the system have resulted in backups from the GLWA connection and basement flooding in some sections of Allen Park. A pump station was built in 2009 to overcome

the hydraulic gradient in the NWI, and it prevented backups into their system. City officials have been meeting regularly with GLWA and MDEQ since February 2001 to discuss the availability of additional capacity. The city undertook a major program in recent years to improve its sanitary sewer system and reduce infiltration and inflow.

The sewer system in Allen Park is separated, but footing drains and downspouts are connected to the sanitary system in many areas. The city has undertaken a program to require disconnection of downspouts and footing drain removal during renovations.

Flow from the Allen Park sewer system is discharged into the Northwest Interceptor through two connection points, AP-S-1 and AP-S-2. Flows at AP-S-1 are measured using an LaserFlow meter installed in May 2018. This connection has an overflow relief outfall to the Rouge River that was included in the system design and remains in place today. With the addition of the pump station, this outfall is no longer needed and is a prohibited discharge, in place strictly for emergency conditions only.

There are three pump stations upstream of the APS-1 outlet: Outer Drive and I-94, Lawrence Avenue, and Watson Avenue. The pump station at Outer Drive and I-94 lifts flows for gravity discharge into the Northwest Interceptor at APS-1. The pump station has two pumps, each at 3.6 mgd (5.6 cfs). Recent inspections indicate that an internal flap gate at the outfall is inoperable, preventing the potential for wet weather events to produced SSOs to the Rouge River through this pathway. From 2008 to 2012, Allen Park implemented a base storage and relief storage tunnel to prevent basement flooding. This project included an emergency pumped outlet which allows the city to pump excess sewage to the North Branch of Ecorse Creek during heavy rain events .

The flows at APS-2 are measured by a recently installed 10-inch magnetic flowmeter. There is no provision for an overflow at this location.

3.3.16 City of Melvindale

Melvindale was incorporated in 1932. It is bordered on the east by Detroit, on the west by Allen Park, on the north by Dearborn, and on the south by Allen Park and Lincoln Park. Several manufacturing facilities are located in the city.

The area of the city is 1,728 acres. Land use in the city is 37 percent residential, 17 percent commercial, institutional, and office, 18 percent industrial, 16 percent transportation, communication, and utility and the remaining 12 percent recreation, open land, and other uses. The housing stock is primarily bungalows and ranches built in the 1920s to 1960s. A large number of residences were constructed in the early 1940s.

Major roads in the area include I-94, I-75, Greenfield Road, and Oakwood Boulevard. The Rouge River runs near the northern border of the city, and the Ecorse River runs along its southern border.

The first agreement for Detroit to accept Melvindale's sanitary flow was established in 1955. This agreement was amended in 1965 and 1969. A final agreement in 1977, allows a maximum flow of 0.5 cfs per 1,000 population, based on the most recent census. Sanitary plus infiltration/inflow to the sanitary system are accepted as long as this limit is not exceeded. Melvindale must meter all

flows which must be pumped into the Northwest Interceptor in Greenfield Road west of Wall Street. The rental charge for the Marathon Oil Company sewer line was increased.

Construction began on the sewer system in Melvindale in 1929 as a separated system with residential footing drains connected. The original system discharged directly to the Rouge River, but it was eventually connected to the GLWA Northwest Interceptor through the Melvindale Pump Station. This connection included an emergency river bypass for surcharged conditions.

The original Melvindale Pump Station was located along the banks of the Rouge River near Greenfield Avenue and Wall Street. In 1966, the deteriorating pump station was replaced. The new pump station was located a few hundred feet away. To avoid potential damage to the aging interceptor, Melvindale was required to use the existing tap into the Northwest Interceptor. This required a 16-inch force main from the new pump station up to the original pump station location. The original emergency bypass to the Rouge River is still available for surcharged conditions.

Melvindale Pump Station has two 4,000 gpm pumps and one 2,000 gpm pump. Sanitary flow is pumped into the Northwest Interceptor through a 16-inch connection at Greenfield Road, 400 feet west of Wall Street. There is a 14-inch magmeter originally installed in 1983 at this location to measure flow to GLWA.

Under wet weather conditions, the new pump station is operated at about 15 cfs and is able to force flows into the Northwest Interceptor. Over the last 7 years, Melvindale has opened the emergency bypass to the Rouge River only one time in order to reduce basement backups occurring during upstream surcharging. By opening the bypass, the pumps are able to operate at about 18 cfs. This occurred during the August 11, 2014, historic storm event which saw up to 5 and even 6 inches of rainfall over several hours.

Seaway Lift Station, located at 19140 Seaway, is also owned and operated by Melvindale. This lift station has two small pumps with unknown capacities.

3.3.17 City of Grosse Pointe

The City of Grosse Pointe was incorporated in 1934 and covers 845 acres (1.32 square miles). The sewer service area is approximately 691 acres. Grosse Pointe is bounded on the east and west by Grosse Pointe Farms and Grosse Pointe Park, respectively. To the north of the city is Detroit and to the south is Lake St. Clair.

Grosse Pointe is a fully developed residential community with virtually no industry. Land use in the city is 86 percent residential (less than 1 percent multi-family housing), 12 percent commercial, institutional, and office, the remaining 2 percent is cultural, recreation, and other uses.

Main streets are East Jefferson Avenue and Kercheval Street. There are no highways through the city.

The agreements between Detroit and all Grosse Pointe communities for sewage flow and treatment were established in 1938 and 1940. The agreements were amended in 1941. Based on the agreements, GLWA treats sanitary flow from Grosse Pointe communities entering the Detroit system from the Fox Creek Enclosure. Grosse Pointe sewers are allowed a peak flow of 124 mgd (192 cfs) for discharge into the Detroit system.

The sewers in Grosse Pointe were mostly constructed prior to 1965, with a large portion constructed between 1930 and 1950. There are approximately 244,000 feet of sewers ranging in size from six-inch diameter to 63-inch by 98-inch arch pipe. The smaller sewers (less than 18-inch diameter) are mostly vitrified clay pipe, while the larger sewers are predominantly reinforced concrete pipe. Infiltration and inflow in the system are affected by levels in Lake St. Clair.

Grosse Pointe's sewer system is about 70 percent separated and 30 percent combined. The area north of Waterloo (one block north of Kercheval) has combined sewers. However, only a few blocks are truly combined sewers; the rest of the system in this area consists of separate storm and sanitary sewers which discharge to a common interceptor. The sanitary and storm flows from this area enter the Grosse Pointe Neff Road Pumping Station via this interceptor and are pumped to GLWA's Fox Creek Enclosure.

The area south of Waterloo has separated sewers with storm sewers discharging to Lake St. Clair through twelve storm outfalls. Sanitary sewers flow to the north and discharge into the main interceptor taking flows to the Grosse Pointe Neff Road Pumping Station.

Grosse Pointe Neff Road Pumping Station contains two small sanitary pumps and four large storm pumps with a total discharge capacity of 294 cfs. The pumping station discharges flows into the Fox Creek Enclosure. The pump station included a meter pit for measuring flows from the sanitary pumps using a venturi. This meter has not been operable for years. It was recently replaced with a magmeter (2017) and is now being used for measuring these flows. Storm pump flows will be estimated using pump curves and levels; implementation of this process is on-going (2017).

3.3.18 City of Grosse Pointe Farms

Grosse Pointe Farms is an established residential community incorporated in 1949, with an official area of 2,041 acres (3.19 square miles). The sewered area is 1,429 acres (2.2 square miles). The community is fully developed and has no significant industry.

Grosse Pointe Farms is bounded on the west by Detroit, on the east by Lake St. Clair, on the north by the North East Sewerage Disposal District and on the south by Grosse Pointe.

Land use in the city is 75 percent residential, 9 percent commercial, institutional, and office, 1 percent transportation, communication, and utility, and the remaining 15 percent is cultural, recreation, and other uses.

Main streets in the district are Lake Shore Road, Kercheval Avenue, and Moross Road. There are no highways through the city.

The topography of the area is fairly level, except for a low plateau rising about 25 feet from the shore in the southeastern section of the city. The underlying soils are mostly clay and sandy clay with seams of sand or gravel. These seams are especially common between Grosse Pointe Boulevard and the lake.

The agreement between Detroit and the Grosse Pointe Farms area for sewage flow was reached in 1938 and amended in 1941. The agreement for sewage treatment was established in 1941, followed by amendments in 1943 and 1947. Dry weather flow from Grosse Pointe Farms and storm flow from a portion of the city discharges into the Fox Creek Enclosure at the Grosse Pointe Farms

Pump Station. The contract agreements with GLWA provide for transport and treatment of all flows entering GLWA's system through the Fox Creek Enclosure. The peak flow allowed for discharge from Grosse Pointe Farms sewers into the Detroit sewer system is 358 mgd (554 cfs). This is equivalent to the current pumping station capacity.

The sewer system in Grosse Pointe Farms was constructed as a combined sewer system divided into two distinct areas, the Lake Area and the Fox Creek Area. The Lake Area is mostly east of Ridge Road and drains to an interceptor in Lake Shore Drive. An interceptor in Kerby Road conveys wastewater from the Lake Shore interceptor to the Grosse Pointe Farms Pump Station. In the past, during wet weather events the combined sewage from the Lake Area overflowed through a number of outfalls to Lake St. Clair. The city separated 800 acres of combined sewered area, a project that was completed by the end of 2002. Most of the area separated is in the Lake Area, south of Ridge Road and east of the Country Club of Detroit.

The Fox Creek area lies to the west of Ridge Road. All of the wastewater from this area discharges to the Grosse Pointe Farms Pump Station and does not overflow to the lake.

Grosse Pointe Farms Pumping Station is located at 305 Chalfonte, immediately adjacent to the Kerby Road Pump Station. It contains eight pumps and has a capacity of 554 cfs. The pumps vary in size from two 2,000 gpm sanitary pumps to two large 75,000 gpm storm pumps. Flow entering the wet well is pumped into the Fox Creek Enclosure. The sanitary flow is metered via a magmeter, installed in an existing metering pit in 2011. Storm flows are estimated using pump curves and levels. These measured/estimated flows were used for billing beginning 4/1/2012.

3.3.19 City of Grosse Pointe Park

Grosse Pointe Park, like the other Grosse Pointe communities, is primarily a residential community. Grosse Pointe Park developed rapidly in the 1920s and 1930s as a suburban residential area close to Detroit, but it was not incorporated as a city until 1950. By 1970, the peak population was reached, and it has declined since then.

The city covers 1,734 acres (2.71 square miles) and is bordered on the north and west by Detroit, on the south by Lake St. Clair and on the east by Grosse Pointe.

Grosse Pointe Park is a residential area with no significant industry. Land use is 92 percent residential (less than 1 percent multi-family housing), 4 percent commercial, institutional, and office, and the remaining 2 percent cultural, recreation, and other uses.

Topography is flat to gently rolling, with ground slopes ranging from 0 percent to 2 percent, but typically 0.1 percent to 0.3 percent. Main streets are East Jefferson and Kercheval. There are no highways through the city.

The agreement between the cities of Detroit and Grosse Pointe Park was established in 1938 for acceptance of sewage flow and amended in September 1940 for sewage treatment. These agreements provide for the transportation and treatment of combined sewage flows up to 54 mgd (84 cfs) to the Detroit River Interceptor.

Grosse Pointe Park until recently had a combined sewer system, consisting of shallow lateral and interceptor sewers and deeper relief interceptors. In general, the laterals run in a north-south

direction. Sewers south of Jefferson Avenue drain north to the interceptor that follows this road. Sewers between Jefferson and Mack drain south to Jefferson. The entire system drains to the Grosse Pointe Park Pumping Station on Jefferson at Maryland Avenue.

Two interceptors in Jefferson Avenue transport sewage from the laterals westward to the pumping station. One is a high-level sewer and the other low-level, with numerous interconnections. The shallower interceptor is a continuation of the Detroit River Interceptor (DRI), but the interceptor is bulkheaded by a permanently-closed backwater gate at Wayburn Avenue, to force flow to the pumping station. A 16-inch force main and 48-inch sewer connect the pumping station to the DRI beyond the bulkhead. Although the GLWA's Fox Creek Enclosure crosses the city, it is not part of the city's sewer system. The city sewers cross under the enclosure by means of inverted siphons.

The total length of sewers in the city is estimated at 49 miles. The shallow-level interceptors were constructed between 1912 and 1926, while the deep relief interceptors were constructed between 1938 and 1956. Many of these interceptors are of elliptical brick construction.

When the sewer system in Grosse Pointe Park was combined, the storm pumps would discharge excess flows to the Fox Creek Channel, which flows eventually to the Detroit River. These flows often ended up overflowing the channel and entering the property of residents in Creekside, a neighborhood in Detroit bordering Grosse Pointe Park. As a result of legal action taken by residents of this neighborhood, the sewer system in the city was mostly separated and a storm water pump station was constructed in Patterson Park.

Patterson Park Storm Water Pumping Station eliminated the perceived need for having overflows to Fox Creek in 2000. There are seven pumps in the station: one storm pump rated at 1.44 mgd (0.93 cfs); two storm pumps each rated at 32.40 mgd (21 cfs) and four storm pumps each rated at 86.40 mgd (55.8 cfs).

Grosse Pointe Park Pumping Station collects wastewater flows and pumps them to the GLWA system. The pump station was originally constructed in 1939 and expanded in 1961. There are eight pumps in the station: three sanitary pumps each rated at 2 mgd (3 cfs); three storm pumps each rated at 23 mgd (35.5 cfs) and two storm pumps each rated at 97.2 mgd (150 cfs). The three sanitary pumps and two smaller storm pumps discharge to the DRI. Before the sewer separation, the two large storm pumps discharged through the Alter Road Outlet Conduit to the Fox Creek Canal. The outfall was sealed shut in 2000 in response to a lawsuit. Because the city did not achieve 100 percent separation, several recent extreme events have resulted in basement flooding which residents noted had not previously occurred.

3.3.20 Other Small Wayne County Districts

There are several small areas in Wayne County that have separate service contracts with GLWA and are considered separate contractual districts, even though they are part of larger areas. These are located in Dearborn Heights, Redford Township, and Harper Woods.

Wayne County Area #3 (Wayne County School District No. 2): This 49-acre area within Dearborn Heights has a 1998 estimated population equivalent (used for flow estimation) of 257. Sewers are combined. The original 1950 contract between Wayne County Board of Road Commissioner and GLWA provided for the connection by Dearborn Township of a 6" sewer from the premises of

School District No. 2 to Detroit's Warren Avenue sewer. The property was located on the east side of Ann Arbor Trail approximately 500 feet south of Warren Avenue. This area is now part of Dearborn Heights.

Other Dearborn Heights Contracts: In addition to the above area, a 1995 list of contracts from GLWA includes two other contracts with Dearborn Heights: A 1949 sewer use agreement for West Parkway Avenue, and a 1950 disposal agreement for the Warren Avenue Sewer. There is also a 1966 sewer use agreement between GLWA and Dearborn Heights for dry weather discharges to the Warren Avenue Sewer.

Wayne County Area #6 (Redford District 6): This 80-acre area in Redford Township has an estimated 1998 population equivalent of 900. Sewers in this area are combined. The original contract between the Wayne County Board of Road Commissioners and GLWA was signed in 1951. In the agreement, Redford Township was to construct a connecting 30" sewer to the 6'-3" Six Mile Road sewer.

Redford Township - 7 Mile and Grand River Area: There is another 47-acre section of Redford Township that has an estimated 1998 equivalent population of 841. The sewers in this area are combined. The contract for service to this area was signed between Detroit and Redford Township in 1935 for a connection to the sewer at Seven Mile and Grand River Avenue.

Section of Harper Woods between Roscommon and Kingsville Roads: This 195-acre section of Harper Woods drains to the Detroit system and is not included in the Northeast Sewage Drainage District. This area has an estimated population of 1,703 and has mostly combined sewers. The 1958 agreement between GLWA and Harper Woods replaces an earlier agreement with Gratiot Township for sewer service. See map of Northeast Wayne County Sewer District on Page 3-31.

Separate and combined sewer areas are described above. These areas do not have any other significant infrastructure features such as interceptors, CSO basins, or other structures.

The flows from these areas are not metered, as most contracts contain an initial lump sum and/or annual lump sum charge for service. The Harper Woods contract, however, bases payment on water usage.

3.3.21 Evergreen-Farmington Sewage Disposal District

The Evergreen-Farmington Sewage Disposal District (EFSDD) is directly north and northwest of Detroit in Oakland County. The system serves 130 square miles in the communities of Bingham Farms, Bloomfield Hills, Bloomfield Township, Farmington Hills, Keego Harbor, Lathrup Village, Franklin Village, Auburn Hills, Orchard Lake Village and parts of Beverly Hills, Birmingham, a small portion of Farmington, Southfield, Troy, West Bloomfield, and Sylvan Lake. The office of the Oakland County Drain Commissioner operates the EFSDD sewer system. The EFSDD originally consisted of the Evergreen and Farmington subdistricts.

Land use in the district is primarily residential with some commercial, office facilities and light industrial. The western part on the district, particularly the northwest, is still undergoing development. The area slopes generally to the southwest and varies in elevation from 1,000 feet to 640 feet.

The first agreement between Detroit and Oakland County for EFSDS sewage flow and treatment was established in 1958. The agreement has been subsequently amended to reflect new requirements. . Peak flow allowed for discharge from EFSDS sewers into the Detroit sewer system is 109.9 mgd (170 cfs).

There are approximately 913 miles of sewers in the district ranging in size from 8" to 78". About 203 miles are trunk sewers and interceptors; about 710 miles are local sewers. Dry weather flow from EFSDS is conveyed by interceptors extending south from the Farmington and Evergreen subdistricts to the East-West Interceptor on Eight Mile Road. The East-West Interceptor is connected by the Evergreen–Farmington Relief Sewer to the First-Hamilton Relief Sewer in Detroit. Originally the EFSDS discharged to the Southfield Sewer in Detroit. However, this outlet was limited in capacity and there were frequent overflows to the Rouge River. In 1984, the Evergreen-Farmington Relief Sewer was constructed between the First-Hamilton Sewer and the North Interceptor/East Arm to transport dry as well as wet weather flows to the Detroit Wastewater Treatment Plant. There is one regulator structure at the connection of the Evergreen-Farmington system to the Southfield Sewer. It is normally closed, but it can be operated to divert flows to the Southfield Sewer if needed for maintenance or other reasons.

Most of the EFSDS sewer system has separated sewers with a small portion of combined sewers in Birmingham and parts of Bloomfield Hills. Some areas of the district with separated sewers have footing drains connected to the sanitary sewers.

The areas with combined sewers discharge to CSO retention treatment basins. Basins in the district are:

Birmingham Retention Basin and Tunnel is located east of Shirley Drive and north of Lincoln Avenue in Linden Park. The basin has a volume of 5.5 MG and treats a peak flow of 330 cfs. The basin serves an area of 1185 acres. Operation of the Birmingham Basin began in December 1997.

Acacia Park Retention Treatment Basin, completed in 1997, is located within the Douglas-Evans Nature Preserve, north of Ronsdale Drive, west of Evergreen Road. The basin is owned by the Village of Beverly Hills, has a volume of 4.0 MG and treats a peak flow of 290 cfs. The basin serves an area of 816 acres.

Bloomfield Village Retention Treatment Basin, completed in 1997, is located on Lincoln Hills Golf Course, has a volume of 10 MG, is sized for a peak flow of 700 cfs and serves an area of 2,325 acres.

Lathrup Village Equalization Basin, located at Evergreen and I-696, is owned by Lathrup Village and began operating in 1992. It is a sanitary retention tank and therefore was not intended to eliminate any CSO outfalls. It has a volume of 3.0 MG, is sized for the 25-year 24-hour design storm with a peak flow of 18 cfs (the influent pumping rate) and serves an area of 950 acres.

The Murwood Street Pumping Station is located on Eight Mile in Southfield and pumps flow to GLWA's First-Hamilton Relief Sewer via the Evergreen-Farmington Relief Sewer. Other pumping stations in the district are the Morris Lake Arm Relief, Walnut Lake #1, Walnut Lake #2, Walnut Lake #3 and Farmington Hills.

There are three overflow structures from the EFSSD to the Evans Ditch, which drains to the Rouge River. In the last 7 years, 4 instances of very small SSOs were reported, on the order of 300 to 500 gallons. A fifth event was reported to have occurred recently (2/20/2018), but no volume was reported with this incidence.

3.3.22 Southeast Oakland County Sewage Disposal District

The Southeast Oakland County Sewage Disposal District (SOCSD) is directly north of Detroit in Oakland County. The district is approximately 41,960 acres and serves the cities of Berkley, Clawson, Ferndale, Hazel Park, Huntington Woods, Madison Heights, Oak Park, Pleasant Ridge, Royal Oak and Royal Oak Township. It also serves parts of the cities of Birmingham, Southfield, Beverly Hills and Troy. The Oakland County Drain Commissioner administers the district.

Land use is primarily medium- to high-density single dwellings and commercial and light industrial.

The original agreement between Detroit and Oakland County for SOCSD sewage flow and treatment was established in November 1962 and amended the next month. The maximum rate and peak flow allowed for discharge into Detroit's sewer system is 168 mgd (260 cfs).

There are approximately 136 miles of sewer in the SOCSD service area, ranging in size from eight inches to 15 feet. Combined sewers serve about 60 percent of the service area.

The SOCSD discharges through the Dequindre Interceptor to the Conant-Mt. Elliott Relief Sewer for transport via the North Interceptor-East Arm and Detroit River Interceptor to the GLWA WRRF. Flows to GLWA are measured through a 66-inch magnetic flow meter located at the intersection of Dequindre and Conant.

Flows to the Dequindre Interceptor are from the following drainage areas:

The Twelve Towns Drainage District which drains facilities approximately 24,000 acres upstream of and including the inlet weir to the George H. Kuhn Retention Treatment Facility.

George W. Kuhn Drainage District, which is downstream of the existing inlet weir to the to the George H. Kuhn Retention Treatment Facility, including the existing facility and the new intermediate weir structure. The district also includes the Hazel Park 10-Mile Sewer, the Madison Heights parallel storm sewers, and the Madison Heights CSO reroute.

Separated sewer areas in Troy, Hazel Park and Madison Heights.

The original combined sewer portion of the SOCSD originally discharged to a branch of the Red Run Drain that ultimately drains to the Clinton River. This was known as the Twelve Towns Drain, because portions of twelve municipalities discharged their combined sewage to it. Interceptor sewers were constructed later to carry the dry weather flow to GLWA's sewer system. The system can still overflow to the Red Run Drain under wet weather conditions. In 1973, the Twelve Towns Retention Treatment Facility was constructed to eliminate additional CSO discharges. Now renamed the George W. Kuhn Retention Treatment Facility, it had a volume of 62 MG with an additional 32 MG of in-system storage upstream of the inlet weir. Modifications were undertaken in 2003 to increase the total volume to 126 MG, including 33 MG of in-system storage upstream of the existing inlet structure. The peak design flow is 6,700 cfs and the detention time is 31 minutes. A

new dewatering pump station, additional weir modifications, new sodium hypochlorite storage building and disinfection system, automatic flushing system, and a new fine-screening system were added. Two to four additional CSO outfalls will be eliminated. The construction was completed by 2005.

A septage receiving station at 29132 Stephenson Highway is described in Section 5.5. The North Arm Relief Drain construction in Birmingham and Royal Oak, was recently completed (2002) with the goal of reducing basement flooding.

3.3.23 Clinton-Oakland Sewage Disposal System

The Clinton-Oakland Sewage Disposal System (COSDS) covers a large section of northwest Oakland County. The district is operated by the office of the Oakland County Drain Commissioner and serves the cities of Auburn Hills, Clarkston, Rochester and Rochester Hills, the villages of Lake Orion and Oxford and the townships of Independence, Oakland, Orion, Oxford, Waterford and West Bloomfield. The district does not include Pontiac which is served by the county-operated Pontiac Wastewater Treatment Plant.

The COSDS covers the largest area of any district in the GLWA system. The estimated total area is 146,430 acres (229 square miles) with a total of 119,813 acres considered the tributary sewered area.

The District includes many of the “outer ring” suburbs in Oakland County that are still being developed. Construction is generally newer and less dense than in the Southeast Oakland and Evergreen-Farmington districts, with some areas still served by septic systems or other facilities.

A sewage disposal and treatment agreement for the COSDS was established between Detroit and Oakland County in 1968. The agreement was amended in 1973. The peak discharge rate is based on population in the district (0.4 cfs per 1,000 population). Peak flow allowed for discharge from the COSDS sewers into the GLWA sewer system is 63 mgd (97.5 cfs). The projected peak flow for 2020 is 113 cfs. The sewer system in the district will remain sanitary per agreement with GLWA.

The sewers in this district receive sanitary flows only, as all sewers are separated. The estimated total length of interceptors is 57 miles and the length of community sewers is an estimated 888 miles. There are also 4,289 feet of force main (10- to 66-inch diameter) from the Elizabeth Lake Pumping Station.

Most areas discharge to the two major interceptors in the COSDD, the Paint Creek Arm and the Clinton Arm. They join just prior to exiting from Oakland County and connecting to the Oakland Arm of the Edison Corridor Interceptor. Near Avon and Dequindre Roads there is 5' 6" diameter connection, and a Parshall flume with a capacity of 162 cfs to measure flows. Flows through these interceptors enter the Edison Corridor Interceptor and eventually end up at the Northeast Pump Station where they are pumped to the North Interceptor-East Arm.

A third interceptor, known as the Avon Arm, serves a smaller area of the district. This interceptor connects to the Oakland Arm Interceptor of the Oakland-Macomb interceptor system at Dequindre near South Boulevard. The connection at this point is through a 30" pipeline. An 18-inch Parshall flume with a capacity of 24 cfs measures the flow.

A small portion of the district, 5,100 acres in southeast Rochester Hills, flows to Southeast Oakland County Sewage Disposal District interceptors.

Elizabeth Lake Pumping Station, the largest pumping station operated by Oakland County, is located in Waterford at the south portion of the Clinton Arm. All of the flow from this portion of the district goes through this pump station. Its tributary sewer area in Bloomfield Township and a large portion of Waterford Township is estimated at 10,100 acres. The station has a maximum allowable capacity of 19.7 mgd (30 cfs). There are five centrifugal pumps in the station. The 1994 Clinton-Oakland SDD Analysis Report lists 101 pumping stations in the district, with an estimated total capacity of 190 cfs, located as follows: Auburn Hills (1); Rochester Hills (1); Lake Orion (16); Independence Township/Clarkston Village (9); Orion Township (14); Oxford Township (7); Waterford Township (50) and West Bloomfield Township (3).

Oakland County Septage Receiving Station was opened in Pontiac in March 2002 to process septage from surrounding communities.

3.3.24 City of Farmington Sewer District

The City of Farmington was settled in 1824, incorporated as a village in 1867, and then as a city in 1926. About three-quarters of Farmington is directly connected to the GLWA sewer system, with the rest served by the Evergreen-Farmington Sewage Disposal District.

The area of the city is 1,424 acres. The community is primarily residential and commercial with no significant industrial discharges. Land use in the city is 66 percent residential (single and multi-family), 21 percent commercial, institutional, and office, 4 percent industrial, and the remaining 9 percent transportation, utilities, recreation, and other uses.

Major roads through the city are Grand River Avenue, Eight Mile, Nine Mile, and Ten Mile roads. There are no freeways through the city.

A sewage flow and treatment agreement were first established between GLWA (Detroit) and Farmington in 1956. The sewage flow agreement was amended in 1958. Farmington has a peak flow allowance of 3.9 mgd (6 cfs) into the GLWA sewer system.

The sewer system in Farmington originally consisted of approximately 60 percent separated and 40 percent combined sewers. In the early 1990s, a sewer separation project was completed that converted the combined portion into a completely separated system. A retention basin and pump station were completed in 1993.

Farmington Nine-Mile Retention Basin is a 3.2 million gallon sewage retention basin within the city. The retention basin treats flows through settling, skimming, and disinfection. During wet weather events, the retention basin discharges to the Rouge River. Separation of the sewers and construction of the retention basin eliminated 10 CSO discharges to the Rouge River.

There are three pumping stations in the city:

- **Nine Mile Road Pumping Station:** Located at the equalization basin, it has three 1,600 gpm pumps with a firm capacity of 3,200 gpm. This pumping station discharges through a force main to the Farmington Sanitary Outfall Interceptor.

- Twin Valley Pumping Station: There are two 100-gpm pumps in this station.
- Chesley Pumping Station: There are two 800 gpm pumps in this station.

Farmington Sanitary Outfall Interceptor, four miles long, starts northeast of the equalization basin and follows Shiawassee Street to the southeast until it joins the GLWA system at Eight Mile Road.

The flow from the City of Farmington sewer system is metered via a Parshall Flume upstream of where it discharges to the Northwest Interceptor at the intersection of Berg Road and Hessel Avenue near Eight Mile Road.

3.3.25 City of Centerline Sewer District

Centerline has an area of 1.7 square miles and is surrounded by the City of Warren (an area not served by the Great Lake Water Authority). Centerline is bordered by 11 Mile Road/I-696 on the north, Stephens Street on the south, Lorraine on the east, and a railroad (Conrail) on the west.

Centerline was incorporated as a village in 1925 and as a city in 1936. The city is primarily residential with significant industrial and commercial land use. Land use in the city is 52 percent residential, 22 percent commercial, institutional, and office, 20 percent industrial, and the remaining 6 percent transportation, utilities, recreation and other uses,

Agreements for sewage flow and treatment between GLWA and Centerline were established in 1960 and amended later that year. The contract allowed a peak flow discharge of 6.5 cfs (4.2 mgd) to the GLWA sewer system. The contract was amended to 8.6 cfs, with an allowance of 12 cfs while working meeting the conditions of their consent decree.

Centerline has 133,000 linear feet of sanitary sewer (83,000 linear feet of which was constructed prior to 1950) and 120,000 linear feet of storm sewer. The sewer system in Centerline was separated in the 1970s. Footing drains are connected to the sanitary sewers, but downspout disconnection has been enforced. In 1998, a \$10 million bond issue was passed to further sewer infrastructure repairs.

The sanitary trunk sewers in Centerline discharge to a 48-inch diameter interceptor under Van Dyke Avenue that typically flows only one-quarter full. The sewage flows to the Stephens Pumping Station. From there it is discharged to a 24-inch sewer that passes through Warren along Van Dyke Avenue. The connection with the GLWA sewer system is just south of Eight Mile Road and east of Savage Street on Conner Avenue.

There are three primary storm sewers in Centerline:

Lorrain Drain is an 11-foot diameter sewer that passes along the eastern city limits of Centerline and discharges to Bear Creek immediately north of 13 Mile Road. This sewer drains the area in Centerline south of 10 Mile Road.

Centerline Tile Drain is a 24-inch diameter sewer located in Van Dyke Road that flows into the Centerline Relief Drain at the intersection of Van Dyke and the I-696 service drive.

Centerline Relief Drain varies in size from 54-inch diameter at 10 Mile Road to 84-inch diameter at the northern city limits.

Stephens Pumping Station, located at the intersection of Stephens and Van Dyke, consists of three pumps with capacities of 800-gpm, 1,900-gpm, and 2,700-gpm at 40-feet TDH. In addition, there is a 5,400-gpm pump powered by a diesel generator that is utilized in the event of a power failure. The station went through a two-phase investigation and rehabilitation program as the result of the 1998 infrastructure bond issue.

The sewage exits the Stephens Pump Station in an 80-foot long, 30-inch diameter pipe. Under dry weather conditions, the sewage continues south along Van Dyke in a 24-inch diameter pipe en route to the GLWA wastewater recovery facility. However, during wet weather conditions, sewage can overflow a weir and discharge into a 36-inch diameter pipe. This pipe empties into a 78-inch diameter storm sewer pipe. The 78-inch diameter pipe empties into the Lorraine Drain, an 11-foot diameter storm drain which discharges into Bear Creek. Bear Creek in turn discharges into the Clinton River and from there discharges to Lake St. Clair. The city is currently addressing sewer overflows into the Lorraine Drain.

In October 2000, high bacterial levels were found in Bear Creek. An investigation revealed that a bulkhead to route flows to GLWA was supposed to be constructed during the sewer separation work but was never completed. For 30 years, sewage was running into Bear Creek instead of flowing into the GLWA system. This construction error has been corrected, but sewer overflows continue to be a problem and are being investigated.

3.3.26 Southeast Macomb Sanitary District

The Southeast Macomb Sanitary District (SEMSD), formerly called the South Macomb Sanitary District, serves the cities of Eastpointe, Roseville and St. Clair Shores. It was until recently a customer of the Northeast Sewage Disposal System (NESDS), which was administered by the Wayne County Department of Environment, Public Works Division (WCPWD). As of last year (2017), SEMSD took control of the NESDS. Ownership and operation of wastewater facilities in the district are complex, involving agreements and operating arrangements among the districts, the city governments, and the Macomb County Public Works Commission (MCPWC). The service area of SEMSD is approximately 24 square miles and is primarily residential.

The SEMSD had a contract peak capacity to discharge up to 102 cfs to the NESDS. The NESDS in turn has an agreement with GLWA to transport and treat up to 127 cfs (82 mgd) of wastewater at point of connection just downstream of the Kerby Road Pump Station. This represents the total flow coming from both SEMSD and NESDS.

The wastewater from the SEMSD is conveyed to the Jefferson Interceptor through nine major sewers operated by SEMSD, Macomb County, St. Clair Shores and Roseville.

The Jefferson Interceptor empties into the Grosse Pointe Interceptor through the Marter Road Booster Pump Station, operated by SEMSD and located at the intersection of Marter and Eight Mile Roads. The outlet capacity for the SMSD is 75 cfs by gravity and about 102 cfs by pumping through MRBPS. Flow to GLWA from the Northeast District is measured through a 42-inch magmeter in front of Kerby Road Pump Station at Kerby and Chalfonte.

The Grosse Pointe Interceptor outlet to the Fox Creek Enclosure may be closed during storms to protect the downstream communities. During wet weather, flows from the SEMSD system enter the Chapaton and the Martin RTBs operated by the Macomb County Public Works Commission. Both basins were constructed in 1969 and provide primary treatment and disinfection of effluent before discharging to Lake St. Clair when basin capacities are exceeded.

Chapaton RTB, located at 9 Mile and Jefferson, has a storage capacity of 28 MG. This basin serves the area tributary to the 8½ and 9 Mile drains and can also accept sanitary flows from the Jefferson Interceptor.

Chapaton Pump Station, located near the basin and also operated by the Macomb County PWC, pump flows from the 8½ and 9 Mile drainage area into the Jefferson Interceptor and the Chapaton Retention Basin, depending on the capacities available. There are four gates in the Chapaton system.

Martin RTB is located at 10½ Mile and Jefferson, has a storage capacity of 8.6 MG and serves the area tributary to the Martin Drain.

Martin Drain Pump Station, located near the basin, and operated by the Southeast Macomb Sanitary District, was constructed in 1991 to pump combined sewage from the Martin Retention Basin into Lake St. Clair. There are two gates in the system.

Hoffman Pump Station is also operated by the district. It is located on the Jefferson Interceptor south of 13 Mile Rd in St. Clair Shores, and it is used to boost flows from the northeast portion of the city south.

There are a number of lift pump stations in the district. Four pump stations that are manually operated by St. Clair Shores to relieve backups in the system are Masonic Boulevard, Hoffman Street, Lake Boulevard, and 12 Mile Road Emergency overflow pump stations. Roseville operates the Mayflower and Washington Avenue pump stations. Eastpointe operates the Pleasant (in St. Clair Shores) and Eastpointe N.E. Relief pump stations. The Michigan Department of Transportation operates the I-94 Stormwater Pump Station in Eastpointe.

The Macomb County Public Works Commission operates the Bon Heur Pump Station, in St. Clair Shores, and the Violet Pump Station in Roseville.

The Southeast Macomb Sewer District recently began a \$65 million construction program, including sewer system improvements, to be completed in 2003. Part of this program will be the construction of a four-foot relief sewer paralleling the Jefferson Interceptor. This new sewer will route some excess flows to GLWA, rather than to Lake St. Clair. After completion of the Jefferson Relief, it was determined that the peak contract capacity of 102 cfs was not being realized at the connection to the NESDS. The Marter Road Booster Pump Station was recently rehabilitated, which enables the district to now achieve the desired peak contract rate.

3.3.27 Macomb County Wastewater Disposal District

The Macomb County Wastewater Disposal District (MCWDD) encompasses most of Macomb County and is operated by the Macomb County Public Works Office. The original contract with GLWA provided service to the cities of Fraser, Sterling Heights and Utica, and the townships of

Chesterfield, Clinton, Harrison, Macomb and Shelby. Subsequently, the agreement was expanded to include Washington and Lenox townships and the Village of New Haven.

The area covered by the MCWWDD was primarily rural until the 1960s. The southern part of this area is now heavily developed. The northern part is still partly rural but is developing rapidly.

The original agreement for sewage disposal and treatment between Detroit and Macomb County was established in 1967. Maximum flows in the agreement were based on population (0.4 cfs per 1,000 population). For projected 2020 populations, the peak flow was estimated at 196 cfs (WWMP 2003). In 2009, Macomb County and Oakland county formed an Oakland-Macomb Interceptor Drain Drainage District. Macomb district and Clinton-Oakland district both became customers of OMIDDD, and OMIDDD in turn became the negotiating entity with GLWA in establishing peak rates at the point of connection at the Northeast Sewer Pump Station. The current contract peak (2018) is 423 cfs.

DWSD constructed and, until sold to OMIDDD, maintained the major interceptors in Macomb County with the exception of the Chesterfield Interceptor. These were built under an agreement that Macomb County would reimburse DWSD for construction, operation and maintenance.

The west branch of the interceptor system, known as the Oakland Arm, meets with the east branch, known as the Romeo Arm, forming the Edison Corridor Interceptor. This 12' 9" diameter interceptor extends from 15 Mile Road to the Northeast Sewage Pumping Station which is located in Detroit, but serves Macomb County and the Clinton-Oakland Sewer District in Oakland County. All flow from the MCWDD is directed through this pumping station.

The Oakland Arm runs from the intersection of 15 Mile Road and Dodge Park to Utica Road and then along Utica Road to Hall Road (M-59). At M-59, the Oakland Arm branches northwest and west. The northwest branch is still called the Oakland Arm. The western branch is called the Avon Arm. The Romeo Arm follows 15 Mile Road east to Garfield Road, then north along Garfield to 18 Mile Road. The Garfield Interceptor extends to 21 Mile Road.

At the corner of 15 Mile and Garfield, the 15 Mile Interceptor continues east to the Clintondale Pump Station. The Lakeshore Interceptor extends generally north from the Clintondale Pump Station to 21 Mile Road, where the Chesterfield Interceptor joins the Lakeshore Interceptor. A North Gratiot Interceptor follows Gratiot from 21 Mile to 31 Mile roads and serve New Haven and Chesterfield and New Haven townships. Other gravity interceptors (Utica, Chesterfield/Macomb, Armada, Richmond, and Memphis arms) are proposed to serve the growing population in Macomb County.

The Edison Corridor Interceptor, the Oakland Arm, and the Avon Arm are owned by the OMIDDD. The Romeo Arm and the major interceptors to the east are now owned by the Macomb Interceptor Drain Drainage District (MIDDD), which in turn is operated by the MCWPC.

There are three pump stations in the MIDDD:

- Clintondale Pump Station, in Clinton Township is operated by MCPWC. It receives flow from the Chesterfield and Lakeshore interceptors and pumps it to the 15 Mile Road Interceptor.

The station was recently renovated, which was completed in 2014. There are three pumps in the station, with room for a fourth, each rated at 35 cfs.

- Garfield Pumping Station at 21 Mile and Garfield roads was abandoned when the new Garfield Interceptor was completed.
- Lenox Pump Station, owned and operated by MCWDD, is located on 26 Mile Road near New Haven. It discharges to the 2.6 cfs capacity Chesterfield Interceptor. Maximum pump capacity is about 0.78 cfs.

The Macomb County sewer system is nearly all separated; however, sanitary sewer overflows are a problem in older communities due in part to footing drains being connected. These older communities are primarily Fraser and Clinton Township. In the past, Clinton Township was fined by the Michigan Department of Environmental Quality for discharging 230 million gallons of sewage into the Clinton River since 1981 through nine emergency (albeit not permitted) pumps (WWMP 2003 Report). Construction of a relief sewer and other measures have been taken to eliminate these SSOs. Over the last 7 years (2011-2017), Clinton Township reported 6.3 MG of SSO to MDEQ, with only 0.17 MG reported over the last 3 years. Fraser also implemented improvements, adding an additional connection to Romeo Arm at the western edge of their community. They have not reported any SSOs since 2011.

3.3.28 Michigan Department of Transportation

The Michigan Department of Transportation (MDOT) operates and maintains 9,688 route miles of roadway in Michigan, and is responsible for all interstate, US and Michigan roadways. (A route mile refers the length of the route. It does not count the length of multiple directions and multiple lanes.) Within GLWA wastewater service area, MDOT operates and maintains 504 route miles of roadway. Within the City of Detroit, MDOT operates and maintains 154 route miles of roadway. The drainage area from MDOT's roadways in Detroit is approximately 3.5 square miles. I-96 was constructed with its own separate stormwater conveyance system with major stormwater outfalls to the Detroit River and the Rouge River. Other MDOT roadways in Detroit drain to the DWSD wastewater collection system which subsequently connects to the GLWA regional system. A significant portion of MDOT's stormwater flows are pumped to the DWSD system and there are over 80 MDOT pumping stations within the Detroit city limits. These pump stations are generally designed to convey flows from a 10-year 1-hour storm.

3.4 Summary of Combined Sewer Service Area

Figure 3-7 presents a map the combined sewer and separated sanitary sewer service areas for the GLWA regional system. Details of the individual wastewater service districts are presented in Section 3.3.

Figure 3-8 presents a map of the service areas of retention treatment basins, screening and disinfection facilities, and remaining combined sewer service areas with limited discharge authority. Table 3-1 summarizes the design criteria of these facilities.

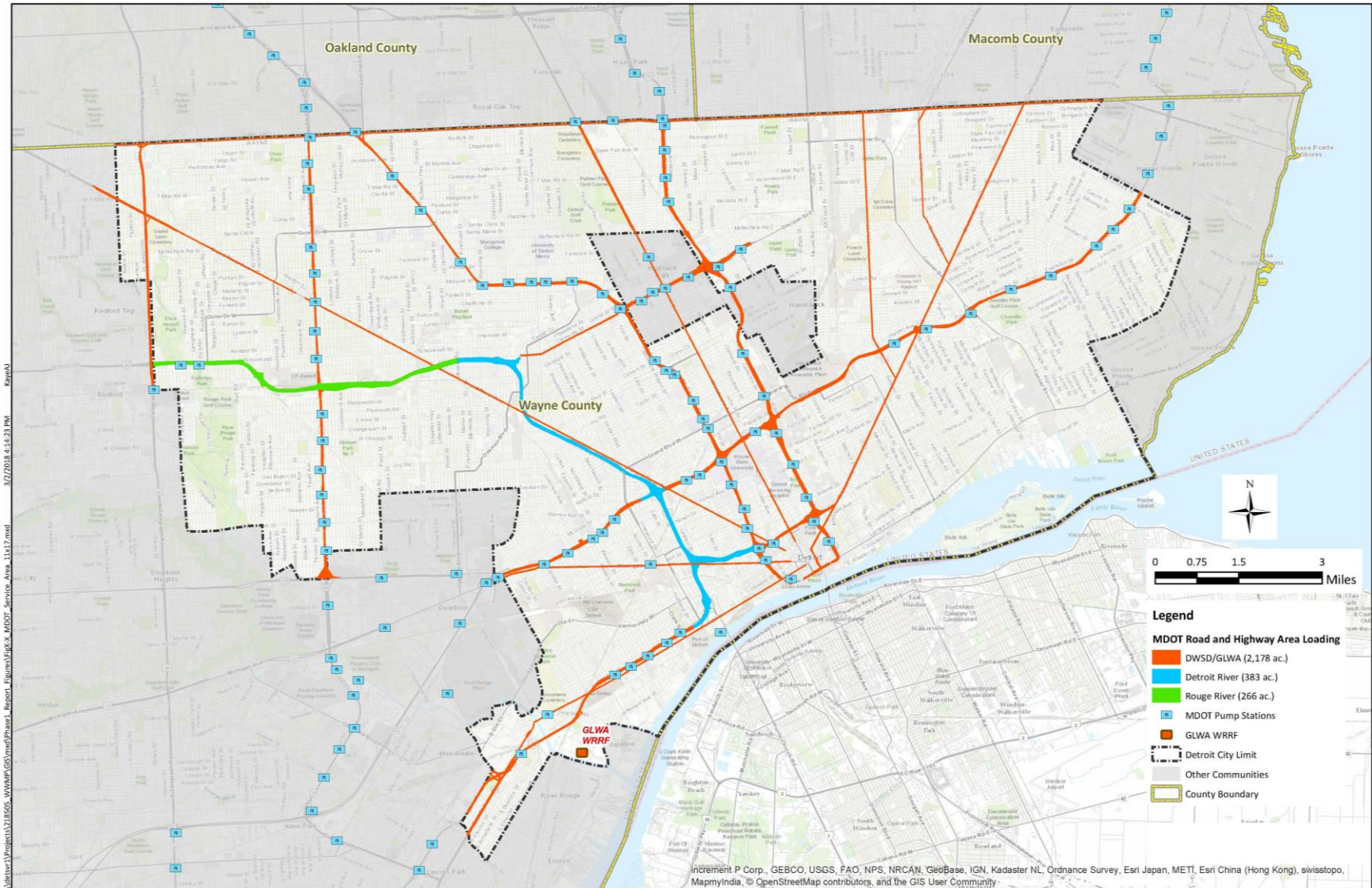

Figure 3-6. MDOT Service Areas and Pump Stations

Table 3-1. Design Criteria of CSO Control Facilities

First Tier Customer	Facility Name	Facility Type	Total Drainage Area (ac)	Separate Sanitary Drainage Area (ac)	Basin Volume (MG)	Influent Storage (MG)**	Design Peak (cfs)	Design Detention Time (mins)	First Year in Operation	Outfall #	Permit number
Oakland County	Acacia Park	Retention Treatment	816	0	4.4	0.5	290	30	1997	103	MI0037427
Oakland County	Birmingham	Retention Treatment	1,185	0	5.5	4	330	30	1997	101	MI0025534
Oakland County	Bloomfield Village	Retention Treatment	2,325	0	10	0.2	700	30	1997	103	MI0048046
Oakland County	GWK	Retention Treatment	24,500	5,464	30	94	6,700		1972/2005	001	MI0026115
GLWA	Belle Isle	Retention Treatment	900		0.3	0	66	10	2008	108	MI0022802
GLWA	Conner Creek	Retention Treatment	83,000		31.5	30.6	13,962	5	2005	104	MI0022802
GLWA	Hubbell-Southfield	Retention Treatment	14,400	0	22	0	3,200	18	2000	101	MI0022802
GLWA	Oakwood	Retention Treatment	1,500		9	0	1,660		2010	109	MI0022802
GLWA	Puritan – Fenkell	Retention Treatment	649	0	4.1	6.4	845	20	1999	102	MI0022802
GLWA	Seven Mile	Retention Treatment	463	0	3.1	1.9	656	30	1999	103	MI0022802
Macomb County	Chapaton	Retention Treatment		0	28	8	1,545	40	1968	001 & 002	MI0025585
Macomb County	Martin	Retention Treatment		0	8.6	3	410	50	1968	001	MI0025453

First Tier Customer	Facility Name	Facility Type	Total Drainage Area (ac)	Separate Sanitary Drainage Area (ac)	Basin Volume (MG)	Influent Storage (MG)**	Design Peak (cfs)	Design Detention Time (mins)	First Year in Operation	Outfall #	Permit number
Wayne County	Milk River	Retention Treatment	4,309	1,724	18.8	0	1,920	20	1994	001	MI0025500
Wayne County	Dearborn Heights	Retention Treatment	340	102	2.7	0.58	500	30	1997	Various	MI0051489
Wayne County	Inkster	Retention Treatment	838	524	3.1	1	500	20	1997	Various	MI0051471
Wayne County	Redford	Retention Treatment	1,831	1,280	1.9	0	190	20	1997	Various	MI0051535
GLWA	Baby Creek	Screening & Disinfection	14,300		28	26	5,100		2007	107	MI0022802
GLWA	Leib	Screening & Disinfection			9.94	0	1,550		2003	105	MI0022802
GLWA	St. Aubin	Screening & Disinfection			2.43	0	250		2003	106	MI0022802

¹ Permit shows 30 MG Basin with 94 MG in-system storage for 124 MG of Storage at Baby Creek

² Basin Influent Storage from Table 3-3 2016 annual report

³ Baby Creek Basin Volume is from three 17.5 by 14.5 barrels called the Baby Creek Enclosure - Total upstream tributary sewers plus enclosure provide 54 MG of storage

⁴ GWK RTF was built in 1972 and upgraded in 2005

GLWA, DWSD and other GLWA Members have expended approximately \$1.8 billion in controlling combined sewer overflows in the last 40 years. The tabulation in Table 3-2 is based on data compiled by SEMCOG, GLWA and Wade Trim Associates. It is reproduced here to document the magnitude and shared commitment over the region. Costs for engineering, administration, legal services and land are not included, and could add another 25 percent to the total, which could bring the actual total to \$2.25 billion. The cost for the River Rouge CSO RTB, which is in the Downriver Wastewater Authority service area, but discharges to the Rouge River, is not currently included, and there may be other projects that should be added to this list.

Table 3-2. Summary of Construction Expenditures for Control of Combined Sewer Overflow Control in the GLWA Regional Service Areas from 1990 to 2017

Facility Name	Operational Responsibility	Status	Storage Volume: million liters (million gallons)	Approximate Construction Cost ^b
Detention Basins				
Belle Isle	DWSD	Operational	1.14 (0.30)	\$16,100,000
Conner Creek	GLWA	Operational	119.24 (31.50)	\$201,000,000
Hubbell-Southfield	GLWA	Operational	83.28 (22.00)	\$54,884,000
Hubbell-Southfield Improvements	GLWA	Operational		\$14,500,000
Oakwood Pump Station	GLWA	Operational	34.07 (9.00)	\$131,437,000
Puritan – Fenkell	GLWA	Operational	15.52 (4.10)	\$18,194,000
Seven Mile	GLWA	Operational	11.73 (3.10)	\$29,948,000
Acacia Park	Oakland County	Operational	15.14 (4.00)	\$10,681,000
Bloomfield Village	Oakland County	Operational	37.85 (10.00)	\$21,994,000
Birmingham	Oakland County	Operational	20.82 (5.50)	\$26,252,000
GWK	Oakland County	Operational	350.91 (92.70)	\$165,068,000
Chapaton	Macomb County	Operational	105.99 (28.00)	\$25,817,000
Martin	Macomb County	Operational	32.55 (8.60)	\$7,471,000
Milk River	Wayne County	Operational	71.92 (19.00)	\$31,200,000
Dearborn Heights	Dearborn Heights	Operational	10.22 (2.70)	\$18,678,000
Inkster	Inkster	Operational	11.73 (3.10)	\$18,592,000
Redford Township	Redford	Operational	7.19 (1.90)	\$14,300,000
SUBTOTAL			929.32 (245.50)	\$806,116,000
Treatment/Capture Shafts				
Capture Shaft 013 (C-2)	Dearborn	Terminated	Not Used	\$28,895,000

Facility Name	Operational Responsibility	Status	Storage Volume: million liters (million gallons)	Approximate Construction Cost ^b
Capture Shaft 014 (C-3)	Dearborn	Abandoned	Filled-in	\$33,097,000
Disinfection Facility for Capture Shafts 013 & 014 (C-1)	Dearborn	Constructed	Included Above	\$4,397,000
Capture Shaft 015 (C-4)	Dearborn	Operational	9.08 (2.40)	\$10,528,000
Original CSO Shafts	Dearborn	Constructed	Included Above	\$26,000,000
Treatment Shaft CSO 006,007 (C-7)	Dearborn	Operational	24.7 (6.6)	40,700,000
Treatment Shaft CSO 008, 009 (C-8)	Dearborn	Operational	29.52 (7.8)	\$170,000,000
Treatment Shaft 016 (C-5)	Dearborn	Abandoned	Filled-in	\$25,997,000
Treatment Shaft 017 (C-6)	Dearborn	Operational	24.61 (6.50)	\$36,791,000
SUBTOTAL			88.2 (23.3)	\$335,705,000
Screening & Disinfection Facilities				
Baby Creek (Including VR-7)	GLWA	Operational	115.08 (30.4)	\$76,100,000
Leib	GLWA	Operational	31.42 (8.3)	\$33,400,000
St. Aubin	GLWA	Operational	9.20 (2.43)	\$19,821,000
SUBTOTAL			155.69 (41.13)	\$129,321,000
Tunnels				
Upper Rouge Tunnels South Segment	GLWA	Terminated		\$22,300,000
SUBTOTAL			760.87 (201.00)	\$22,300,000
In-System Storage Facilities (Dams and Gates)				
Conner Creek Influent Storage Gates, PS, & RTB	GLWA	Operational	152.93 (40.40)	\$15,000,000
Wyoming Relief (ISD001)	GLWA	Operational	23.24 (6.14)	
Weatherby (ISD002)	GLWA	Operational	11.92 (3.15)	
Upper Livernois Relief (ISD003)	GLWA	Operational	9.24 (2.44)	
Joy (ISD004)	GLWA	Operational	13.55 (3.58)	
Clark Summit (ISD005)	GLWA	Operational	15.06 (3.98)	
First Hamilton (ISD006)	GLWA	Operational	34.14 (9.02)	
First Hamilton (ISD007)	GLWA	Operational	16.77 (4.43)	
First Hamilton (ISD008)	GLWA	Operational	14.99 (3.96)	

Facility Name	Operational Responsibility	Status	Storage Volume: million liters (million gallons)	Approximate Construction Cost ^b
First Hamilton (ISD009)	GLWA	Operational	16.20 (4.28)	\$26,469,000
First Hamilton (ISD010)	GLWA	Operational	5.38 (1.42)	
Conant Mt. Elliott (ISD011)	GLWA	Operational	34.18 (9.03)	
Six Mile Rd. (ISD012)	GLWA	Operational	8.86 (2.34)	
Seven Mile Rd. (ISD013)	DWGLWASD	Operational	13.51 (3.57)	
6 Mile & 6 Mile Relief Outfall Gates	GLWA	Operational	26.12 (6.90)	\$7,708,000
Puritan Outfall Gates	GLWA	Operational	1.14 (.30)	\$3,400,000
Lyndon Outfall Gates	DGLWAWSD	Operational	6.44 (1.7)	
Lahser Outfall Gates	GLWA	Operational	5.30 (1.4)	
W. Chicago Outfall Gates	GLWA	Operational	19.68 (5.2)	
Tireman Outfall Gates	GLWA	Operational	21.58 (5.7)	
Rouge District In-System Storage Gates Retrofit-Rehab	GLWA	Operational		\$1,400,000
Bloomfield Hills, Birmingham, Acacia Park	Oakland County	Operational	18.17 (4.8)	\$1,552,000
GWK Influent Weir Storage	Oakland County	Operational	124.92 (33.00)	Included w/GWK Basin
Frisbee Sewer	City of Detroit	Operational	7.19 (1.9)	\$2,043,000
SUBTOTAL			600.52 (158.64)	\$56,172,000
Equalization Basins (as part of CSO Elimination Program)				
Farmington	Farmington	Operational	12.11 (3.20)	\$5,000,000
City of Wayne	Wayne County	Operational	8.71 (2.30)	\$3,827,000
Livonia	Livonia	Operational	8.33 (2.20)	\$1,029,000
SUBTOTAL			29.15 (7.70)	\$9,856,000
Sewer Separations/Relief Sewers and Collection System Upgrades				
Carbon Outfall and Fort St Outfall Elimination				\$100,000
Area 25	City of Wayne	Operational		\$221,000
Areas 19, 20, 23	City of Wayne	Operational		\$2,454,000
Area 18	City of Wayne	Operational		\$82,000

Facility Name	Operational Responsibility	Status	Storage Volume: million liters (million gallons)	Approximate Construction Cost ^b
SUBTOTAL				\$2,857,000
Sewer Separations/Relief Sewers and Collection System Upgrades				
Farmington	Farmington	Operational		\$9,000,000
Midtown West	Garden City	Operational		\$9,727,000
Midtown East	Garden City	Operational		\$6,435,000
South Venoy	Garden City	Operational		\$1,228,000
Merriman	Garden City	Operational		\$459,000
Perrin & Middlebelt	Garden City	Operational		\$10,848,000
Robinson Subdivision	Plymouth Township	Operational		\$557,000
Districts 30, 31, & 32	Plymouth Township	Operational		\$341,000
Area 42	Westland	Operational		\$346,000
Area 38	Westland	Operational		\$1,364,000
Area 10 (Contract 1 & 2)	Westland	Operational		\$4,010,000
Area 10 (Contract 3)	Westland	Operational		\$1,874,000
Area 10 (Contract 4)	Westland	Operational		\$768,000
Grosse Pointe Farms	Grosse Pointe Farms	Operational		\$10,000,000
Grosse Pointe Park	Grosse Pointe Park	Operational		\$18,600,000
Eastpointe Roseville Separation	Macomb County	Operational		\$4,184,000
So. Macomb Relief Sewers	Macomb County	Operational		\$15,269,000
So. Macomb Pump Station/Bypass Structure	Macomb County	Operational		\$22,827,000
Areas Tributary to CSO 10,11,12,20	Dearborn			\$
Areas Tributary to CSO 001-005	Dearborn			\$
Area Tributary to CSO 016	Dearborn	Operational		\$6,380,000
Miller Rd. Pump Station Renovation	Dearborn	Operational		\$8,000,000
SUBTOTAL				\$135,074,000
Operational Elements				

Facility Name	Operational Responsibility	Status	Storage Volume: million liters (million gallons)	Approximate Construction Cost ^b
Fischer PS Improvements & St. Aubin Effluent Mods	GLWA			\$4,600,000
Fairview Pump Station	GLWA	Operational		\$6,072,000
VR-15 (Conant Mt. Elliott)	GLWA	Operational		\$6,902,000
VR-17 (Shiawassee Gate)	GLWA	Operational		\$198,000
VR-8 (Hubbell-Southfield)	GLWA	Operational		\$800,000
PC-713 Instrumentation and Control Devices	GLWA	Operational		\$16,000,000
SUBTOTAL				\$34,572,000
GLWA WRRF				
Primary Clarifiers No. 17, 18	GLWA	Operational		\$101,200,000
PS-2A (Additional Pump)	GLWA	Operational		\$2,048,000
Original Detroit River Outfall	GLWA	Operational		\$88,200,000
Modified Detroit River Outfall	GLWA	Operational		\$7,100,000
Rouge River Outfall Segment 1	GLWA	In-Construction		\$46,000,000
SUBTOTAL				\$244,548,000
TOTAL EXPENDITURE				\$1,773,664,000

^a Listing does not include facilities to control sanitary sewer overflows (SSOs) from separate sewer systems except for equalization basins which were built to retain excess wet weather flows in newly separated combined sewer systems.

^b Construction costs reflect the cost to build the facility (as-bid contractor's cost plus or minus change orders) and have not been adjusted to account for inflation since the project was built. Costs do not include engineering, administrative, land acquisition or legal expenses.

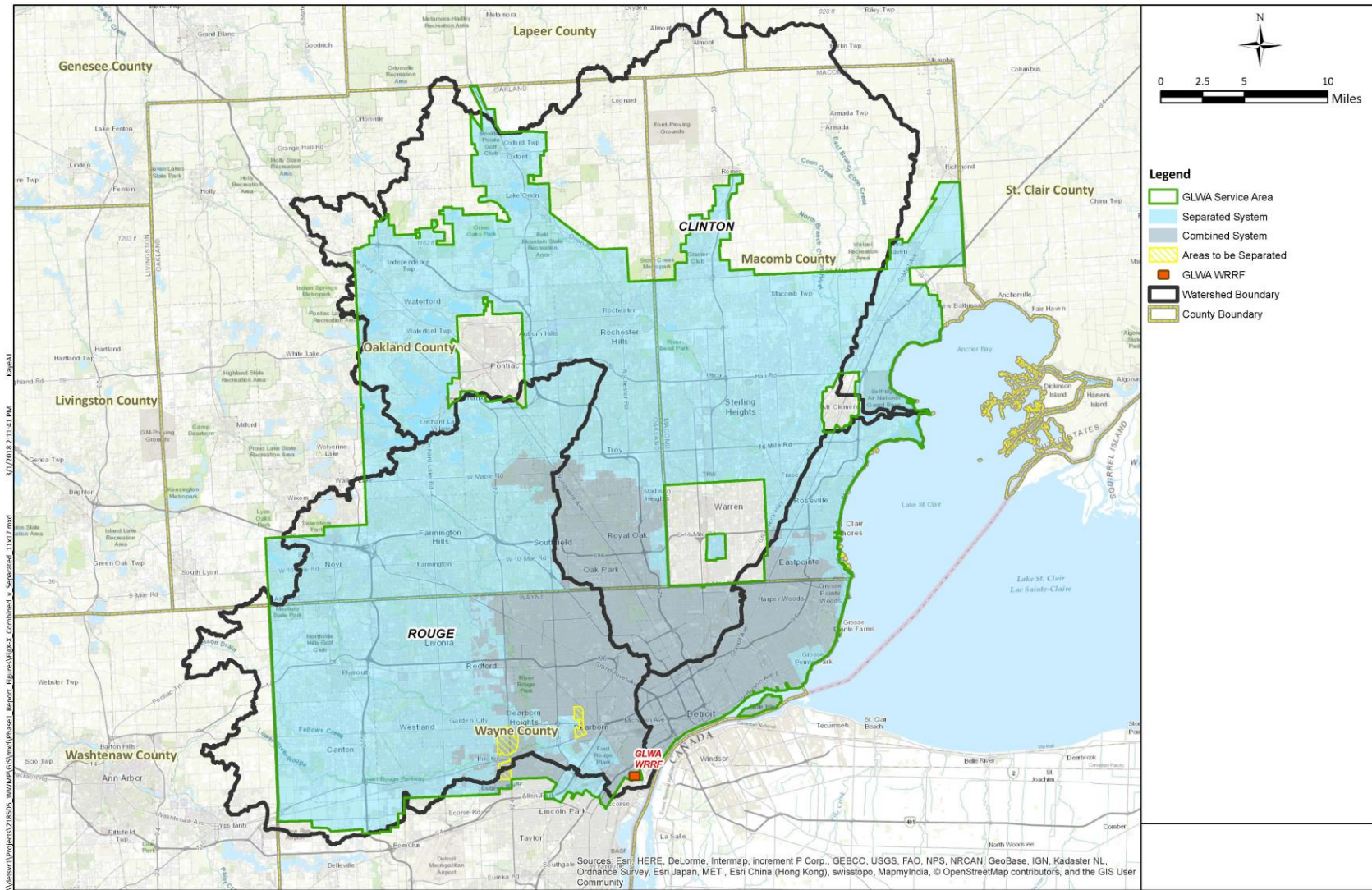

Figure 3-7. GLWA Wastewater Service Area Separated and Combined Systems

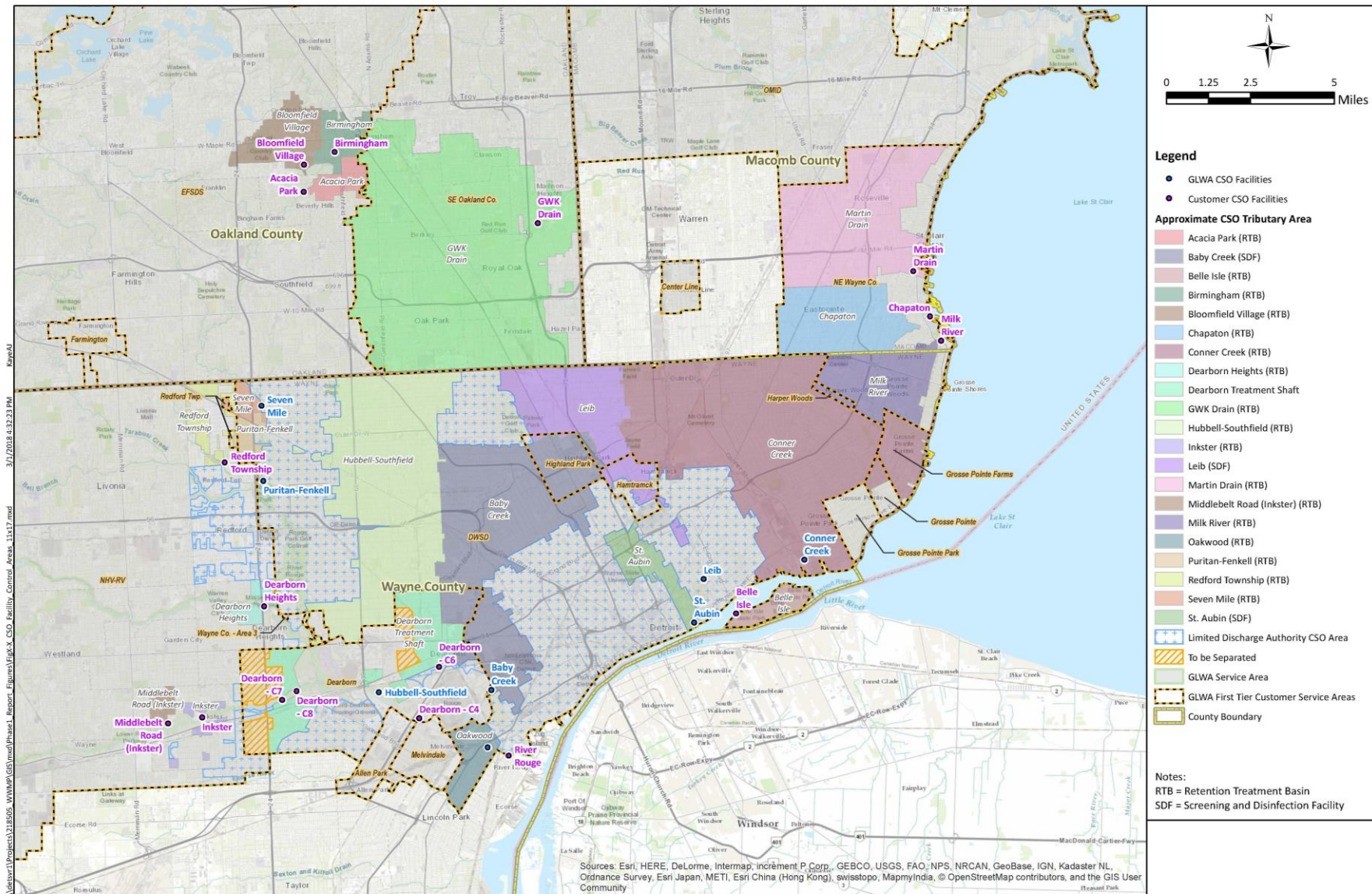

Figure 3-8. GLWA and Member CSO Control Facilities and Approximate Drainage Areas

3.5 Water Resource Recovery Facility

The Water Resource Recovery Facility (WRRF) is located in southwest Detroit. Construction of the original treatment facility began in 1925 and was completed in 1940 after a series of construction projects. Secondary treatment was implemented in the 1970s in response to the Clean Water Act. Table 3-3 describes the major upgrades and improvements to the facility from 1925 to the present.

Table 3-3. History of Major Improvements at the WRRF

Interceptor, Pumping or Process Area	Time Period	Contract Number	Description of Construction or Upgrade
Detroit River Interceptor	1925 to 1940		Construction of DRI
Oakwood Connecting Sewer	1939	OI-2	The contract also installed 36" reinforced concrete pipe and an under-river tunnel with two shafts to connect the area south of the Rouge River to the Oakwood interceptor and ultimately to the influent pump station.
Pump Station 1	1940		Construction of PS1
Pump Station 1	1956		Two additional pumps added
Pump Station 2 and NIEA	1988	PC-655	Pump Station 2 connected the previously complete NIEA to the WRRF
Pump Station 2	2000 to 2004		Added another influent pump
Rectangular Primary Clarifiers	1927		Installed original clarifier Units 1 to 8
Rectangular Primary Clarifiers	1956		Installed clarifier Units 9 and 10
Rectangular Primary Clarifiers	1970		Installed clarifier Units 11 and 12
Rectangular Primary Clarifiers	1991 to 1995		Replace main longitudinal collectors and cross collectors, repaired concrete inside the tanks for all units
Rectangular Primary Clarifiers	2001 to 2005		Replace troughs and weirs with 316SS
Rectangular Primary Clarifiers	2016		Crack repair, replace longitudinal and cross collectors with drive mechanisms.
Circular Primary Clarifiers	1971		Construct Units #13 and 14
Circular Primary Clarifiers	1980		Construct Units #15 and 16
Circular Primary Clarifiers	2005		Construct Units # 17 and 18
Circular Primary Clarifiers	2014	PC-756	Rehab of clarifiers 13-16 involved replacement of internals (mechanism, scum deflector, skimmer arm, effluent trough)
Activated Sludge Process	1970	PC-1970	Construct Intermediate Lift Station

Interceptor, Pumping or Process Area	Time Period	Contract Number	Description of Construction or Upgrade
Activated Sludge Process	2003	PC-751	Intermediate Lift Station Replace Pumps 1 and 2
Activated Sludge Process	Early 1990s	CM-640	Install Intermediate Lift Pumps 3, 4, and 7
Activated Sludge Process	1970	PC-233	Installation of Aeration Tanks 1 and 2. Aeration tank 1 originally designed as air activated sludge tank with coarse bubble diffusers, aeration tank 2 oxygen activated sludge with mechanical splash aerators. Included design for future conversion
Activated Sludge Process	2003	PC-744	Aeration tank 1 converted to oxygen
Activated Sludge Process	1974	PC-283	Install aeration tank #3 and 4 as oxygen reactors
Activated Sludge Process	2005	DWP-1054	Switch from on-site generation of HPO to Praxair HPO supply
Activated Sludge Process	1972 to 1979		Secondary clarifiers constructed
Activated Sludge Process	2000 to 2005	PC-720	Rehabilitation included replacement of center drives, new flowmeters, replace weirs and troughs, sludge blanket detectors.
Detroit River Outfall	1938		Original outfall construction
Detroit River Outfall	2003		Chlorination upgrade and de-chlorination added
Rouge River Outfall	2017 to 2019	PC-797	Disinfection/dechlorination upgrades under construction
Sludge Thickening	1972	PC-241	Complex A constructed
Sludge Thickening	1976	PC-294	Complex B constructed
Sludge Thickening	2006		Complex A and B rehabilitated
Sludge Dewatering	1940		Complex I vacuum filters installed
Sludge Dewatering	1992	PC-616	Complex I belt filter presses installed
Sludge Dewatering	2000		Complex II Lower Level Centrifuges: Installed 8 Units
Sludge Dewatering	2000	PC-691	Complex II Upper Level Belt Filter Presses: Installed 12 Units
Sludge Dewatering	2014 to 2017	PC-787	Complex I and II Belt Filter Presses: Replaced 20 Units
Biosolids Drying	2015	PC-792	New BDF collects liquid sludge from blend tanks then dewateres with centrifuges, and dry in rotary drum dryers prior to haul agricultural land application

Interceptor, Pumping or Process Area	Time Period	Contract Number	Description of Construction or Upgrade
Incineration	1940		Installed Complex I
Incineration	1970		Installed Complex II
Incineration	2013	PC-791	Air quality improvements including new quench water system, wet scrubber, and venturi scrubber.
Incineration	2013 to 2016		Decommissioning of Complex I incinerators
Process Control Center	2004	PC-744	Development of plant schematics and P&IDs

The facility accepts flow through the three main interceptors – the Detroit River Interceptor (DRI), Oakwood/Northwest Interceptor (O-NWI) and the Northeast Interceptor-East Arm (NI-EA). In 2018 the WRRF serves approximately 2.8 million residents in southeast Michigan through a combination of separate and combined sewer systems. Over the period 2015 to 2017, the WRRF treated approximately 650 million gallons per day (mgd) of wastewater. The peak primary treatment capacity for wet weather flows is 1,700 mgd (the largest in the nation), and the peak secondary treatment capacity is 930 mgd. Flow in excess of the peak secondary facility capacity bypasses secondary treatment and is discharged through the Detroit River Outfall (049) up to its capacity of 1,150 mgd. Flow in excess of the Detroit River Outfall capacity is directed to the Rouge River outfall.

The major treatment processes at the WRRF are presented on the attached liquid train and solids train process flow diagrams Figures 3-9 and 3-10 and described below. A more detailed description of the WRRF and its performance can be found in Section 5 and in Technical Memorandum 5.

3.5.1 Liquid Stream Treatment Processes

3.5.1.1 Raw Wastewater Pumping Stations Nos. 1 and 2 (Including Grit and Screenings)

Two wastewater pumping stations on-site lift the flow from the three main interceptors to the treatment processes. Approximately 34 percent of the flow comes from the DRI, 32 percent from the O-NWI, and the remaining 34 percent from the NI-EA. Each pump station has eight pumps with a combined total installed capacity in excess of 2 billion gallons per day.

The DRI and the O-NWI flow to PS-1 and the majority of the sidestream flows are also directed to PS-1. Constructed as a part of the original plant in the late 1930s, PS-1 is equipped with eight constant speed pumps of varying capacity (6 from the original construction and two added in 1956), with a firm total capacity of 1,129 mgd. Pumps have been rehabilitated throughout their lives with the latest rehab undertaken in 2004 and 2005. Each pump has a dedicated discharge channel, a dedicated catenary bar screen and two dedicated grit chambers. This arrangement impacts the system reliability since a pump must be taken out of service if a screen or grit chamber is out of service. Ferric chloride can be added ahead of the pumps for phosphorus removal. There are four Venturi meters downstream of the grit chambers for flow measurement into each of the four banks of rectangular clarifiers. Flow from PS-1 can also be directed to the circular clarifiers from PS-1 but there is no direct flow measurement here.

The NI-EA and Oakwood Interceptors flow to PS-2, constructed in 1994 and equipped with eight mixed-flow pumps each with a design capacity of 115 mgd during wet weather conditions, for a firm design capacity of 805 mgd. Overtime, the capacity of these pumps has diminished with a current estimated capacity closer to 89 mgd each, reducing the firm capacity of the PS-2 to 623 mgd. Magnetic flow meters on the discharge of each pump provide total flow measurement from PS-2. Wastewater pumped from PS-2 flows to a common influent channel to eight mechanically cleaned bar screens increasing the operational reliability. Similarly, a common channel introduces flow to the aerated grit tanks. Grit removal is through an overhead clamshell removal system. Ferric chloride is added to the discharge channel from the aerated grit tanks for phosphorus removal. Septage is discharged to the Oakwood Interceptor upstream of PS-2.

3.5.1.2 Primary Treatment

Primary treatment is achieved through 12 covered rectangular clarifiers and 6 circular clarifiers. During dry weather flow from PS-1 flows by gravity to the 12 rectangular clarifiers and flow from PS-2 flows by gravity to the 6 circular clarifiers. During wet weather conditions a portion of the flow from PS-1 can be directed to the circular clarifiers.

Each of the twelve rectangular clarifiers is rated to treat 90 mgd each. Chain and flight sludge and scum collection equipment direct primary sludge to the influent end of the tank and primary scum to the effluent end of the tank. A cross collector in each tank directs the primary sludge to the primary sludge pump suction pipe. The primary sludge pumps are constant speed, on-timers, and pump primary sludge to the gravity thickeners in Complex A. A scum cross collector on the effluent end of the tank directs scum to a scum vat, which is then pumped to a scum concentrator on an intermittent basis, and ultimately hauled off-site.

The six 250-ft diameter circular primary clarifiers (No. 13 through 18) are currently rated at 180 mgd each. In 2006, magnetic flow meters were installed on the effluent of each of the eight circular primary clarifiers which serve to equalize flow through each of the clarifiers. Primary sludge is removed from the circular clarifiers with a rake mechanism and sludge pumps which pump sludge to the gravity thickeners in Complex A. Primary sludge pumps are constant speed and cycle on and off based on a timed setting. Scum is collected at two points in each clarifier and transferred to the scum handling system.

3.5.1.3 Secondary Treatment

Primary effluent, up to 930 mgd, is pumped through the intermediate lift pumps (ILPs) from the PEAS (primary effluent to activated sludge) tunnel to the four aeration decks, where it is mixed with return activated sludge. ILP station No. 1 houses two “mixed flow” centrifugal pumps, with VFDs, each with a maximum capacity of 365 mgd. ILP No. 1 feeds aeration decks 1 and 2. ILP station No. 2 houses three “mixed flow” centrifugal pumps (Nos. 3, 4 and 7), each with a rated capacity of 350 mgd. Pumps 3 and 4 feed aeration decks 3 and 4, while pump 7 can feed aeration decks 2, 3 and 4.

The facility uses a high purity oxygen activated sludge system. The original cryogenic oxygen generation system has been decommissioned and the facility currently receives high purity oxygen (99.5 percent) through a pipeline directly from the Praxair facility. Aeration decks 1 and 2 consists of 10 bays, while aeration decks 3 and 4 have 8 bays, however, the volume of each deck is about

17.8 MG. Each deck has a rated capacity of 310 mgd forward flow (+65 mgd RAS). As with all oxygen activated sludge systems, pure oxygen is introduced to the headspace of the first bay, high efficiency aerators in each bay entrain the oxygen into the mixed liquor and maintain the mixed liquor in suspension. Oxygen in the headspace is controlled by maintaining a dissolved oxygen set point of 2 to 5 mg/L in all bays and a pressure of 2 to 4-inch water column in the headspace. The initial mixers in bay 1 for each aeration tank have been out of service for many years as there is believed hydraulic mixing to get oxygen into solution. On occasion in Aeration Tank 3 and 4, the first of 4 bay 1 mixers is in service.

Mixed liquor flows by gravity to 25 secondary clarifiers each 200-ft in diameter with peripheral feed and draw-off. Each clarifier has its own dedicated variable speed vertical wet pit pump station to return activated sludge to the head of the aeration decks. Sludge is wasted continuously from the RAS line to the Complex B gravity thickeners.

3.5.1.4 Disinfection

Secondary effluent is disinfected and dechlorinated using chlorine gas and sulfur dioxide. Currently, chlorine solution is added to Junction Chamber No. 1 and from there the secondary effluent flows through the Detroit River Outfall (DRO) to the Detroit River. Contact time is provided in the outfall pipe. The capacity of the DRO is dependent on the elevation of the Detroit River. At the average river elevation of 94.5 feet, the DRO has a capacity of approximately 1,100 mgd. The chlorine dose is set to maintain a chlorine residual of 1.3 to 2 mg/L prior to dechlorination. Sulfur dioxide is fed to the effluent flow near the outlet of the DRO to reduce the chlorine residual to less than 0.11 mg/L.

Currently, primary effluent in excess of the secondary capacity of the WRRF is routed to the DRO for disinfection and discharge to the Detroit River. Any additional primary effluent discharge that exceeds the capacity of the DRO is not disinfected and is routed to the Rouge River Outfall for discharge to the Rouge River.

Construction of modifications to the RRO to accommodate chlorination and dechlorination is currently ongoing and expected to be complete in 2019. This new process will include a new upstream chlorination location for secondary effluent that provides additional contact time, and a separate chlorination location in the primary effluent channel using sodium hypochlorite. The DRO will continue to be dechlorinated using sulfur dioxide, and the RRO will be dechlorinated using sodium bisulfate. This new upgrade will provide disinfected discharges to both the Rouge and Detroit rivers.

3.5.2 Solids Stream Treatment Processes

The solids stream treatment processes consist of gravity thickening of the solids generated in primary and secondary treatment which occurs in two separate facilities, Complex A for primary sludge and Complex B for thickened waste activated sludge; dewatering of the thickened solids using both high solids centrifuges and belt filter presses (BFPs), pumping a portion of the thickened sludge to the new Biosolids Drying Facility (BDF); incineration of a portion of the dewatered solids and offloading the remainder of the dewatered solids (after lime addition) to trucks for either land application or landfill disposal. Current operating procedure is to maximize throughput to the BDF, followed by maximizing throughput to incineration, with a last resort being lime addition at the

sludge off-loading facility first to land application and lastly to landfill. The existing processes are described below.

3.5.2.1 Gravity Thickening

Complexes A and B each consists of six gravity thickeners. Each is 105' diameter with a 15' sidewater depth and 27' depth from the center. Each thickener has a center driven rake mechanism to convey the thickened sludge to the draw-off point at the bottom of the thickener. Ten recessed impeller centrifugal pumps transfer the thickened primary sludge (TPS) to inline blending with thickened WAS (TWAS) pumped through six recessed impeller, centrifugal pumps. One pump per thickener runs continuously and the speed of each pump is adjusted manually to maintain a sludge blanket within a desired range.

Screened final effluent (SFE) is pumped continuously to the gravity thickeners to prevent odors and septicity with a target of up to 0.5 to 1.0 mgd per thickener. SFE is also pumped continuously when a tank is not receiving primary sludge or WAS.

Thickened sludge is pumped to one of six thickened sludge storage tanks. Thickened sludge is pumped to downstream processes using a combination of recessed impeller, centrifugal and chopper type pumps. Blowers are used to keep the solids in suspension of tanks nos. 1 to 4 and mixing pumps for tank nos. 5 and 6.

3.5.2.2 Sludge Dewatering

GLWA can dewater sludge with either belt filter presses or centrifuges located in Complex I and II and in the Biosolids Drying Facility. Ten 2-meter belt filter presses (BFPs) are available in Complex I, and twelve 2-meter BFPs are located in Complex II. Eight Westfalia centrifuges are located on the lower level of Complex II and have been problematic due to excessive grit wear and are not used. Four Sharples centrifuges are also located on the lower level of Complex II. The new Biosolids Drying facility discussed below include eight Alfa Laval centrifuges. All dewatering units in Complexes I and II use Mannich polymer. The BDF centrifuges utilize a dry polymer that is mixed, aged and pumped as a solution for dewatering.

3.5.2.3 Incineration

The Complex I incinerators were constructed in 1940 and include six, 11 hearth units with capacity of 10 wet tons/hr. These were decommissioned in early 2017.

Complex II Incineration were constructed in the 1970s and consists of 8 multiple hearth incinerators each containing 12 hearths with an outside diameter of 25'-9" as made by Nichols-Herreshoff. The rated capacity of each is 3.2 dtph. During the 2006 wet weather evaluation, the average unit capacity was reduced to 2.5 dtph, but increased back to rated capacity following the PC-791 upgrades. Thus, the firm C-II Incineration capacity is 461 dtpd based on 6 of 8 incinerators in service and a 25 percent TS feed cake concentration.

Each incinerator has 17 burners that use natural gas. The burners can be controlled manually at their local panels or manually and automatically at the central control panel. In automatic operation, the burner fuel supply valve is controlled by temperature controllers in each burner hearth, and are used to preheat the incinerator, ignite the sludge, maintain standby temperatures, and maintain the necessary temperature in the hearths to dry and combust the sludge to an inert

ash. The operating target is to be within 1100 to 1500°F in the burning zone. GLWA typically operates with a top hearth temperature of 1250°F.

Induced draft fans are used to draw air through the incinerator, air pollution control equipment, and discharge the air to atmosphere through one of three stacks. The air pollution control equipment is used to cool and remove particulates and gaseous pollutants from the exhaust gas. The exhaust gas oxygen level is monitored at the scrubber system inlet. The opacity and total hydrocarbon (THC) concentrations are monitored at the discharge of the scrubber system. The bypass exhaust stack is used when the incinerator is on standby or out of service.

The inert ash is discharged from the incinerator into a dry ash hopper equipped with a crusher. Typically, crushed dry ash is moved by a vacuum system to storage silos. From the ash silos, the ash is wetted to control fugitive dust, and discharged to trucks via an ash silo unloading system. The wetted ash is hauled to an offsite landfill.

3.5.2.4 Biosolids Drying Facility

The Biosolids Drying Facility (BDF) is operated and maintained by the New England Fertilizer Company (NEFCO) under a 20-year contract. It went into operation in August 2015 and was given Beneficial Use in mid-February 2016. GLWA owns the dryer facility which has capacity of 92 dtpd with three dryers in service.

Sludge is fed from pumps at the GLWA thickened sludge storage tanks to the BDF, where flow proceeds through an inline grinder, rotary lobe centrifuge feed pump and centrifuge. There are 8 grinders, centrifuge feed pumps and centrifuges. From each pair of centrifuges, cake drops into a cake bin, a twin-screw feeder and inclined belt conveyor where recycled finished product mixes in a pug mill. This raw cake and recycled pellet mix is fed to one of four triple-pass rotary drum dryers by a screw conveyor.

The dried biosolids exits the dryer and is vertically conveyed pneumatically, together with process air to a cyclone separator. The separated pellets then drop through a rotary air lock and into the screener which separates the pellets by size to segregate the properly sized materials, to recycle inappropriately sized material, and to remove coarse trash material. The Class A finished product is hauled off-site for distribution and is typically land applied in Michigan, Indiana, Ohio and Canada.

3.5.2.5 Central Offload Facility

The Central Offload Facility (COF) has the capacity and capability of offloading sludge from all three dewatering complexes. The COF has three rectangular live bottom sludge storage bins with associated discharge screws. Each bin has a storage capacity of 200-220 wet tons, with two discharge points underneath each bin. The bins are used to store the dewatered sludge cake received from upper and lower levels of C-II Dewatering via conveyor belts, and from C-I Dewatering via cake pumps through a 16-inch diameter pipeline.

Sludge can also be directed to lime mixers before offloading to a truck. The purpose of lime addition is to reduce odors if the solids are landfilled or to meet Class B requirements if the solids are land applied. The requirement to hold the solids for a specified time is met by holding the solids in the truck prior to discharge at the land application site.

There are three lime storage silos with associated equipment. There are also three sludge/lime mixers, each with an electrically actuated slide gate for truck offloading. The sludge storage bins discharge sludge either directly to trucks, or to lime mixers where lime is added. In the latter case, the lime mixed sludge is offloaded to the trucks for landfill. One of the three mixers (No. 3) can also discharge to the lime pad, which is situated on the south side of COF Building.

The COF has a rated capacity of 300 dtpd.

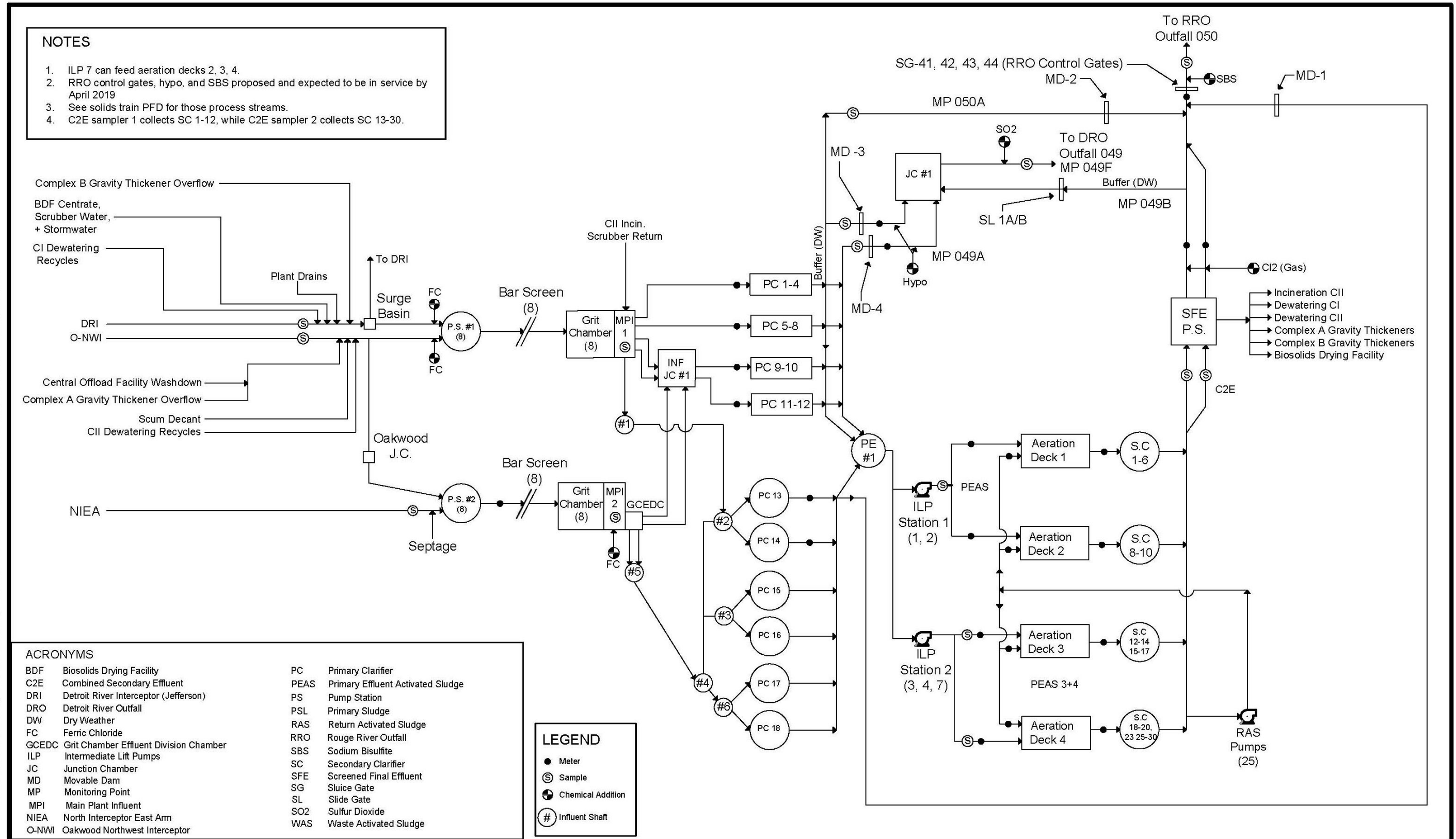

Figure 3-9. GLWA Water Resource Recovery Facility, Existing Liquid Train PFD

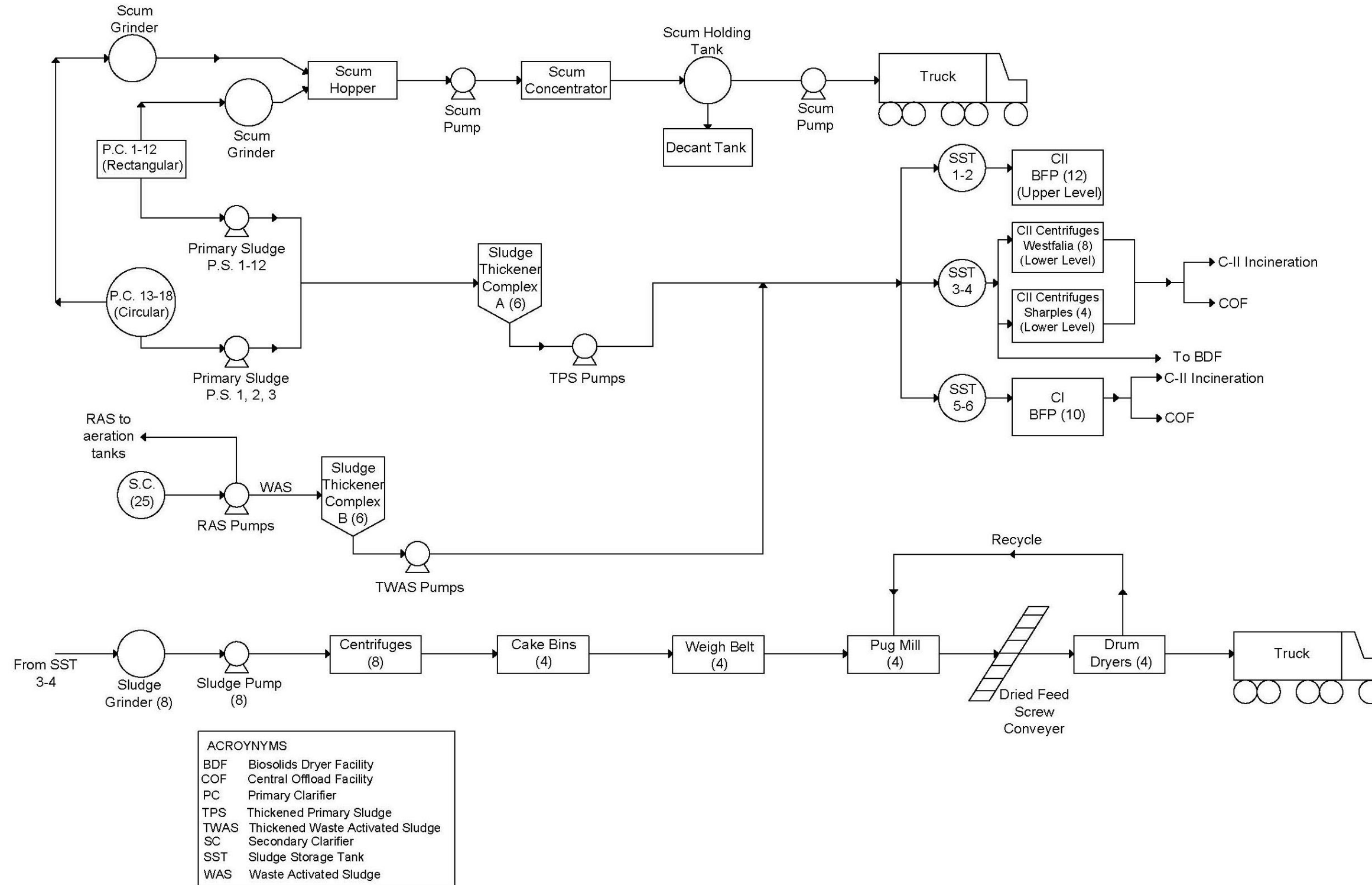

Figure 3-10. GLWA Water Resource Recovery Facility, Existing Solids Train PFD

Section 4

Regulatory Requirements

4.1 Overview

This chapter describes the history of water quality regulatory programs of state and federal agencies and compliance by the Great Lakes Water Authority (GLWA) and its customers. The key regulatory milestones and initiatives that have preceded this master plan are described, as well as the current status of National Pollutant Discharge Elimination System (NPDES) permits and administrative consent orders. Customers served by GLWA (Members) have played a significant role in shaping the history of regulatory compliance, and highlights of Member-led achievements are presented throughout this chapter.

This chapter is presented in three major sections. First, a history of regulation and compliance is presented. Second, the current status of regulatory compliance is described. And third, potential future regulation and evolving policy for wet weather regulatory compliance are examined. The history of regulations and compliance is outlined in the following report sections:

- Great Lakes Water Quality Agreement
- Clean Water Act
- Consent Decree and Federal Oversight
- Rouge River National Wet Weather Demonstration Project
- Water Resource Recovery Facility
- Combined Sewer Overflows
- Sanitary Sewer Overflows
- Michigan Drain Code

The current regulations and compliance are documented in the following report sections:

- Formation of the Great Lakes Water Authority
- NPDES Permits in the Region
- Administrative Consent Orders in the Region
- Long-term Combined Sewer Overflow (CSO) Plan
- Industrial Waste Management
- Green Stormwater Infrastructure
- Municipal Separate Storm Systems

The final part of this chapter includes considerations for the future regulatory compliance landscape and options for GLWA and its Members to pursue under the US EPA Integrated Planning Framework and State of Michigan watershed permits, and to prepare for in terms of potential future regulations.

4.2 History of Regulations and Compliance

There are number of significant events in the past that have had a major influence on pollution control throughout the state, but particularly in the highly populated area of Southeast Michigan. Collectively, these historical events provide the foundation for the current regulatory framework that the master plan examined while developing recommendations to meet the region's needs over the next 40 years.

Michigan water pollution control efforts preceded those of the federal government with the passage of the Water Resources Commission Act in 1929. However, since the federal government passed the Clean Water Act (CWA) in 1972, Michigan has primarily been responding to changes in federal laws and regulations to maintain its delegated authority by the U.S. Environmental Protection Agency (U.S. EPA) under the National Pollutant Discharge Elimination System (NPDES) program. Table 4-1 below establishes the dates for significant events related to water pollution control in Southeast Michigan. Note the frequency of significant events has increased since the CWA's passage, particularly during the period from 2013 to the present.

Table 4-1. Significant Events in Michigan

Water Pollution Management	
1927	Michigan Water Resources Commission, PA 245 of 1929
1956	Michigan Drain Code Codification, PA 40 of 1956
1972	Clean Water Act of 1972 and creation of U.S. EPA
1973	U.S. EPA Delegation of NPDES Program to Michigan
1977	Federal Court Consent Decree U.S. EPA/Michigan v. City/Detroit Water and Sewerage Department (DWSD)
1978	U.S./Canada Great Lakes Water Quality Agreement (GLWQA)
1983	U.S. EPA Rules for Industrial Discharges (pretreatment program)
1992	National Wet Weather Demonstration Project (Rouge Project)
1994	National Combined Sewer Overflows (CSO) policy
2004	Michigan Watershed Alliance Law, PA 517 of 2004
2006	Alliance of Rouge Communities (ARC)
2013	Federal district court oversight of DWSD ends, and Detroit files for Chapter 9 bankruptcy
2014	Federally funded Rouge Project ends
2015	New Michigan stormwater regulations to meet federal requirements
2016	Great Lakes Water Authority begins operation

4.2.1 Great Lakes Water Quality Agreement

The 1978 Great Lakes Water Quality Agreement (GLWQA) is administered through the International Joint Commission in cooperation with U.S. and Canadian federal governments, eight Great Lakes states, and two Canadian provinces to restore and protect Great Lakes waters. The

stated purpose in the agreement is to restore and maintain the chemical, physical, and biological integrity of the Great Lakes Basin ecosystem. The agreement provides a framework for identifying binational priorities and implementing actions that protect and improve Great Lakes water quality. Early work between the two countries dates back to the *Treaty Relating to the Boundary Waters and Questions Arising Along the Border Between Canada and the United States* signed on January 11, 1909. The GLWQA was one of several driving forces behind the CWA.

A governing body of the agreement, known as the Great Lakes Executive Committee, is comprised of representatives from the U.S. EPA and Environment and Climate Change Canada. Additional members include indigenous representatives and local public government organizations. The goal of the membership structure is to represent local community perspectives in remedial actions and implementation of water quality protection on a regional scale. The executive committee meets two or more times a year to establish priorities and review and report on progress made in each country.

The 1987 GLWQA amendments established Lakewide Action and Management Plans (LAMPs) and remedial action plans (RAPs) as systematic and comprehensive ecosystem approaches to address the Great Lakes as a whole and specific areas of concern throughout the lakes, respectively. The LAMP and RAP documents also provide an historical record of assessments of critical pollutants, proposed remedial actions and methods of implementation, changes in environmental conditions as a result of remedial actions, and significant milestones in restoring beneficial uses of the lakes.

Over time, the GLWQA has been amended and has expanded its focus. The following timeline highlights past and current focus areas:

- 1972: Phosphorus loadings and visible pollutants
- 1978: Persistent toxic substances and ecosystem approach to lake management
- 1983: Updated phosphorus reduction strategies
- 1987: RAPs, areas of concern, and LAMPs
- 2012: Modernized, enhanced governance and new and expanded annexes (e.g., habitat protection)

Each of these amendments are briefly reviewed below.

The original 1972 GLWQA targeted the reduction of algae. The U.S. and Canada agreed on a coordinated approach to limiting phosphorus inputs, actions were taken to reduce excess algae growth, and phosphorus levels in the Great Lakes declined significantly during the 1970s and 1980s. This was an unprecedented success in demonstrating the benefit of binational cooperation to achieve measurable environmental improvements.

In 1978, the GLWQA was revised to reflect a broadened goal “to restore and maintain the chemical, physical, and biological integrity of the waters of the Great Lakes Basin ecosystem.”¹ The two significant shifts of the 1978 GLWQA were the introduction of the ecosystem approach—

¹ Great Lakes Water Quality Agreement of 1978, United States/Canada, International Joint Commission, signed November 22, 1978.

the notion of taking the whole ecosystem into account (and not just certain parts)—and the call for virtual elimination of toxic pollution.

In 1983, a supplement was added to the GLWQA to further limit phosphorus discharges, and Canada and the United States committed to preparing and implementing new plans for reducing phosphorus.

The GLWQA was amended again in 1987 to incorporate new commitments to reduce toxic pollutants through development and implementation of LAMPs for each lake and to clean up areas of concern through the implementation of RAPs. These plans emphasize citizen and local government engagement to restore water quality and rapidly reduce the levels of toxic pollutants in the lake ecosystem.

The GLWQA specifically defines areas of concern as "geographic areas that fail to meet the general or specific objectives of the agreement, where such failure has caused or is likely to cause impairment of beneficial use of the area's ability to support aquatic life."² The goal of the agreement is to restore and maintain the chemical, physical, and biological integrity of the Great Lakes Basin ecosystem through a concerted set of interventions that are targeted at areas of concern. Because each waterway has a unique set of characteristics that have contributed to its ecological impairment, a RAP has been developed to identify the causes of impairment. The goal of each RAP is to bring about the delisting of the waterway from the list of areas of concern and to restore individual waterways by guiding local action.

The latest amendment to the agreement in 2012 added preventative measures to address issues that have arisen since the 1987 amendment. The 2012 change invited additional organizations to participate in policy formation and remediation as well as created the GLWQA Nutrients Annex Subcommittee that will help target a recurring algal bloom in Lake Erie that continues to persist from uncontrolled phosphorus inputs that require binational coordination.

4.2.2 Clean Water Act

The 1972 amendments to the Federal Water Pollution Control Act of 1948 are commonly referred to as the Clean Water Act.^{3 4} The amendments are:

- Structured regulations to control discharges to the waters of the United States
- Authorized the U.S. EPA to implement wastewater standards
- Maintained existing water quality standards for all contaminants in surface waters
- Required permits for all point source pollutant discharges
- Funded sewage treatment plants under a construction grants program
- Recognized the need for planning to address pollution problems posed by nonpoint pollution sources

² Revised Great Lakes Water Quality Agreement of 1978, as amended by Protocol, signed November 18, 1987 and consolidated by the International Joint Commission.

³ USEPA: National Pollutant Discharge Elimination System (NPDES). 2018. (On line accessed 3/09/2018) Available <https://www.epa.gov/npdes>

⁴ Michigan Department of Environmental Quality. 2018 (On line accessed 3/9/2018) Available <https://www.mi.gov/deqnpdes>

Michigan had been issuing orders controlling discharges to the waters of the state since the passage of the Water Resource Commission Act of 1929. The state received formal delegated authority from the U.S. EPA in October of 1973 to administer the federal NPDES permit program. Michigan was one of the first states to receive delegated authority under the CWA and has maintained this authority for the program ever since. Today, this delegated authority for the U.S. EPA NPDES program resides in the Michigan Department of Environmental Quality (MDEQ).

The CWA established the following principles:

- The discharge of pollutants to navigable waters is not a right
- A discharge permit is required to use public resources for waste disposal and limits the amount of pollutants that may be discharged
- Wastewater must be treated with the best treatment technology economically achievable regardless of the condition of the receiving water
- Effluent limits must be based on treatment technology performance, but more stringent limits may be imposed if the technology-based limits do not prevent violations of water quality standards in the receiving water

The first round of NPDES permits issued by Michigan between 1973 and 1976 focused on five-day biochemical oxygen demand (BOD₅), total suspended solids (TSS), pH, oil and grease, and some metals, by requiring the use of the best practicable control technology (BPT) then available. The CWA established a July 1, 1977, deadline for all facilities to be in compliance with BPT. Additionally, the act established the compliance deadline for installing best available technology economically achievable (BAT) by July 1, 1983.

The concept of BAT controls was clarified and expanded to include toxic pollutants. The conventional pollutants (BOD₅, TSS, pH, fecal coliform, and oil and grease) controlled by BPT in the first round of permitting became subject to a new level of control, termed best conventional pollutant control technology (BCT). The federal compliance deadline for meeting both expanded BAT and new BCT controls was July 1, 1984.

Further amendments to the CWA in 1981 streamlined and improved capabilities of municipal treatment plants constructed with federal funds. In 1987, other changes to the CWA phased out the construction grants program and replaced it with the State Water Pollution Control Revolving Fund, which required state match for subsidized construction loans to municipalities for pollution control facilities. The 1987 CWA amendments, sometimes referred to as the Water Quality Act of 1987, also outlined a strategy to accomplish the goal of meeting water quality standards set by the states throughout the country. Michigan water quality standards are designed to not only protect aquatic life (fishable) and recreation (swimmable), but also to ensure safety in other uses of the receiving waters, including agriculture, public and industrial water supply, and navigation.

For the first time, the 1987 amendments established new schedules for industrial and municipal stormwater discharges to be regulated by NPDES permits. Industrial stormwater discharges under the amendments must achieve the equivalent of BCT/BAT effluent quality, and municipal separate storm sewer systems (MS4) must require controls to reduce the discharge of pollutants to the maximum extent practicable. The 1987 amendments once again extended the time to meet BAT and BCT effluent limitations, with a new compliance deadline of March 31, 1989.

The passage of other federal laws has since modified parts of the CWA, most notably the Great Lakes Critical Programs Act of 1990 that adopted certain provisions of the GLWQA. This 1990 law required the U.S. EPA to establish criteria limits for 29 toxic pollutants to assure that water discharges were safe for humans, wildlife, and aquatic life. The law also designated 43 Areas of Concern (AOC), geographic areas where significant impairment of beneficial uses has occurred as a result of human activities at the local level. The Rouge River was designated as an AOC under the GLWQA and a RAP has been prepared to address nine beneficial use impairments (BUIs) identified. Based upon substantial improvements achieved over the last 15 years, a number of the original BUIs are being considered for formal delisting under the GLWQA.⁵

Current criteria of Section 303(d) of the CWA, require all states to identify waters that are not expected to meet water quality standards (nonattainment areas) after technology-based controls on point sources have been imposed. States must then prepare an individual control strategy that would include Total Maximum Daily Loads (TMDLs) for permitted point sources contributing pollutants related to the nonattainment status. Among other measures, these plans were expected to address control of pollutants beyond technology-based levels.⁶ While a significant portion of the upper Rouge River watershed in the GLWA service area now meets Michigan water quality standards, a number of downstream areas, although significantly improved, do not yet meet standards for full-body contact activities like swimming or minimum dissolved oxygen levels designed to protect fish and aquatic organisms. Wet weather sanitary sewer, combined sewer and stormwater discharges within other portions of the GLWA service area also prevent attainment of water quality standards in downstream areas.

4.2.3 Michigan Drain Code

The Michigan Drain Code, which has a long history in Southeast Michigan where, two centuries ago, many thought the area was too wet to support development. The stressors that drainage projects often place on the aquatic community, although gradual and not always visible, are often profound unless mitigated. Under the CWA, the U.S. EPA issued regulations governing stormwater runoff, known as Phase II regulations. Briefly, Phase II makes use of a “best management practice” (BMP) approach (see Section 4.3.6).

The state laws establishing the authority for drains, drainage districts, and assessing properties for improvements under county drain commissioners was codified in Act 40 of the Public Acts of 1956 into the Michigan Drain Code (Drain Code) that was subsequently amended in 1970, 1973, and 1982.⁷

Chapters 20 and 21 of the Drain Code authorize the generation of funds to support capital improvement and operations of conveyances and treatment facilities to protect public health. Interagency agreements are used in conjunction with drainage district petitions to define the roles and responsibilities of the drainage district and the cooperating public agencies as well as the apportionment of capital and operating costs among drainage district members. The interagency agreements establish the mechanism for creating a drainage board composed of public entities being served as well as the board’s decision-making role.

⁵The Rouge River Area of Concern – Beneficial Use Impairments Delisting Strategy 2012. Alliance of Rouge Communities. (On line accessed 3/9/2018). Available <http://www.allianceofrougecommunities.com/PDFs/PI/Final%20Revised%20Strategy%20Report050812.pdf>

⁶U.S. EPA: Impaired Waters and TMDLs 2017. (On line accessed 3/9/2018). Available <https://www.epa.gov/tmdl/program-overview-impaired-waters-and-tmdls>

⁷ State of Michigan Legislature. The Drain Code of 1956, Act 40, 1956. (On line accessed 3/9/2018) Available [http://www.legislature.mi.gov/\(S\(z3xyta55ko23eyv254oltt55\)\)/documents/mcl/pdf/mcl-Act-40-of-1956.pdf](http://www.legislature.mi.gov/(S(z3xyta55ko23eyv254oltt55))/documents/mcl/pdf/mcl-Act-40-of-1956.pdf)

In Michigan, a county drain commissioner is generally an elected position. However, in very small counties, there is the option for county road commissions to assume the duties of the drain commissioner; in very large counties that elect a county executive, the county charter determines who assumes the duties of the drain commissioner. In counties that establish a department of public works, the authority of a drain commissioner resides with the elected public works director. In some Michigan counties, the title of drain commissioner is no longer used in favor of a title reflecting the broader responsibilities of the individual or county office (e.g., Water Resources Commissioner), but the statutory authority for carrying out the responsibilities of the county drain commissioner under state law is specifically assigned to an individual in each county under the Michigan Drain Code.

Once established, the interagency agreements accompanying the formation of a drainage district define the role of participating local units of government in decisions related to the drainage district's operation. The interagency agreements allocate costs, but usually leave it to local units of government in the district to determine how best to meet each unit's financial obligations (e.g., the local governmental unit may choose to use locally generated ad valorem taxes, rates/fees, special assessments, or some combination of revenue generation).

In Southeast Michigan, the significant population growth and urban sprawl following World War II in former rural areas surrounding Detroit and the relatively quick formation of new small cities, villages, and charter townships made the creation of sanitary sewer districts under the Michigan Drain Code an attractive alternative for many communities. This urgent need for sanitary sewer infrastructure to serve an expanding population as well as county capital-borrowing advantages encouraged the formation of sanitary sewer districts in Oakland, Macomb, and Wayne Counties. While some long-established cities and larger newer cities had the resources to expand or build their own sanitary and stormwater sewer systems, the smaller cities, newer cities, villages, and rapidly growing townships chose to use the Michigan Drain Code to meet urgent infrastructure needs.

The Wayne County Department of Environment, operating under the Michigan Drain Code, provides sewer services that involve the transport of stormwater and wastewater from local cities and townships located in the north, west, and central portions of the county outside of Detroit city limits through an interceptor system for eventual treatment and discharge by the GLWA. Wayne County also operates, under the Michigan Drain Code, and has a separate wastewater transport and treatment system for downriver communities not connected to the GLWA system.

Similarly, in Oakland and Macomb Counties, the Drain Code was used to establish sanitary waste drainage districts for cities, townships, and villages. The districts contract for the transport and treatment of sanitary wastewater through interceptors connected to the GLWA/DWSD system. Some districts in these counties operate detention and treatment facilities on their own during major storm events.

Prior to the 1950s, the DWSD primarily served the city of Detroit and the residents of Gratiot Township (Harper Woods), Grosse Pointe City, Grosse Pointe Farms, Grosse Pointe Park, Grosse Pointe Woods, Hamtramck, Highland Park, Redford Township, St. Clair Shores, Southfield Township, and Warren Township. However, in the mid-1950s the DWSD began promoting expansion to add both water and sewer customers. Drainage districts already established in Wayne, Oakland, and Macomb Counties were encouraged to send their waste to the DWSD facilities. In addition, expanding or newly forming sanitary wastewater districts created under the Drain Code in parts of these three counties closest to Detroit found the option of sending their

sanitary wastewater to the DWSD more cost effective than building and operating their own treatment facilities.⁸

4.2.4 Consent Decree and Federal Oversight

Beginning in the mid 1970s, the U.S. EPA and state regulatory agencies began enforcing actions throughout the U.S. district court system to force compliance with CWA requirements. At the same time, the U.S. EPA began administration, primarily through the states, of federal grant and aid programs to help reduce costs for construction and upgrades to publicly owned collection and treatment systems. These federal funds were often supplemented with state matching grants and/or subsidized loans.

Following hearings before the U.S. District Court for the Eastern District of Michigan, the U.S. EPA, in collaboration with the State of Michigan, entered into a consent decree with the DWSD and the City of Detroit specifying actions required by the city and the DWSD in order to achieve compliance with the CWA and related Michigan water pollution laws and regulations. This 1977 consent decree established federal district court oversight of DWSD and began a series of activities by the City, the DWSD, the State of Michigan, and U.S. EPA under the guidance of the federal district court-appointed master to achieve compliance with the federal and state water pollution control laws and regulations.

Progress in resolving the compliance issues identified in the 1977 consent decree was substantially assisted by grant funding included with the passage of the federal Rouge River National Wet Weather Demonstration Project (Rouge Project). This federal demonstration grant program was successfully advocated before the United States Congress and passed with bipartisan support from Michigan's congressional representatives, and subsequently administered by the Wayne County Department of Environment. The contributions made through the Rouge Project in addressing CSO discharges to the Rouge River is detailed in subsequent sections.

During the course of the U.S. district court hearings on how best to address CSOs and separated sewer system overflows (SSOs), documentation was presented to the court that demonstrated that even if these overflows were successfully resolved, the Rouge River would not likely achieve the water quality standards established under the CWA. The court initially favored the creation of an intercounty drainage district under the Michigan Drain Code to be administered jointly by Wayne, Washtenaw, and Oakland Counties to address illicit sanitary discharges and other sources of pollution from stormwater discharges to the Rouge River.

The court's suggestion was objected to by the three counties and the cities, villages, and townships whose stormwater drained to the Rouge River. The court accepted the alternative proposed by the areas, an organization called the Assembly of Rouge Communities (later formally established under state statute as the Alliance of Rouge Communities) that would collectively and cooperatively address stormwater and other nonpoint pollution sources. The role of the alliance in addressing stormwater issues in the GLWA service area as well as the role of the Rouge Project in helping address stormwater issues in Michigan and throughout the country are discussed in a following section.

In March 2013, Federal Judge Sean Cox lifted the federal oversight saying:

⁸ Detroit Water and Sewer Department – The First 300 years. The Detroit Water and Sewerage Department. (On line accessed 3/13/2018) Available http://dwsd.org/downloads_n/about_dwsd/history/complete_history.pdf

“The court concludes that, after more than 35 years of federal oversight, the DWSD has achieved substantial compliance with its NPDES permit and the Clean Water Act. This court shall therefore terminate the second amended consent judgment and close this case because the existing administrative consent order is a sufficient mechanism to address future issues regarding compliance with the DWSD’s NPDES permit and the Clean Water Act.”

4.2.5 Rouge River National Wet Weather Demonstration Project

The Rouge Project was directed by Wayne County Department of Environment following funding by the U.S. Congress in 1992. Initially, Rouge Project funding focused on the construction of ten CSO treatment facilities for previously untreated discharges to the Rouge River. Nine of these facilities, the design and construction of which preceded the publication of the U.S. EPA’s national CSO policy, began operation between 1997 and 2000 and were the subject of intensive study for their first two years of operation (U.S. EPA 1994). The basins located in the Rouge watershed being studied serve drainage areas as large as 14,400 acres and as small as 360 acres. The facilities were constructed under terms of negotiated consent agreements with the MDEQ.

The Rouge Project facilities were intended to demonstrate effective treatment of wet weather flows to protect public health with the secondary function as a retention facility to reduce pollutant loading to the river. Protection of public health involves two key aspects: (1) elimination of raw sewage and (2) disinfection of discharges. Seven basins were designed to treat flows from one-year, one-hour storms (approximately 1.0”); two basins were designed for ten-year, one-hour storms (approximately 1.7”); and one basin was built within site constraints. The facilities were designed to provide screening, skimming, and settling in order to remove raw sewage, and were designed with disinfection capability, including chemical dosing systems and volume for residence times in the basins from 20–30 minutes at the peak-hour flow associated with the design storm. The basins are composed of multiple compartments. Some of these compartments may act as capture facilities for the first flush. Some facilities are equipped with shunt channels to allow for bypass flow if necessary (or desired) to prevent washout of accumulated solids. As a result of these investments, approximately 89 of the 127 miles of stream in the Rouge River watershed are now free of the adverse impacts of uncontrolled CSO discharges.

Although control of CSOs was identified as a major priority, it had been previously demonstrated in federal district court that CSO control alone would be insufficient to achieve water quality standards. Discharges from sanitary sewer overflows (SSOs), stormwater runoff, illicit connections, discharges from failed onsite sewage disposal systems, and other pollution sources needed to be addressed. Even if all these varied sources of pollution were brought under control, it was also clear that natural stream flows, wetlands, upland habitat, and over-enriched lakes needed attention if the fishery, wildlife, and other natural resources valued by the public were to be restored. The focus of the Rouge Project became holistic and considered the impacts from all sources of pollution and use impairments in receiving waters. The Rouge Project reflected this holistic watershed approach in its administration of grants to local governments and nonprofits for enhancement of the Rouge River watershed.

In 1997, the MDEQ promulgated rules to implement a unique watershed approach to stormwater management that was developed by the communities and counties participating in the Rouge Project as a response to both the mandates of the federal district court and the pending U.S. EPA Phase I and II NPDES stormwater regulations. The local participants in the Rouge Project under its informal memorandum of agreement formed the Assembly of Rouge Communities in 2003 and supported the passage of a new state law authorizing the formation of watershed alliances in

2005 (PA 517 of 2004). The Assembly of Rouge Communities ARC was formally established under state law in 2006 as the Alliance of Rouge Communities (ARC) and played a large role in implementing the Rouge Project in cooperation with Wayne County. The ARC is a 501(c)3c non-profit as well as a governmental entity and routinely seeks and acquires state, federal, and private grant funds to match member contributions to supporting the projects for environmental improvement activities of its members and partners, non-profit environmental organization. By 2007, there were 40 communities, three counties, and the Wayne County Airport Authority that had adopted the ARC bylaws in order to become members, and in 2017, there were 44 members.

In 2008, the ARC updated and consolidated seven Rouge River subwatershed management plans developed under the Rouge Project into one sustainable Rouge River Watershed Management Plan (WMP). This plan was built on the successful Rouge Project grant-supported demonstrations and laid the groundwork for future improvements in water quality. The plan was approved by MDEQ in July 2012 as it met the U.S. EPA's Section 319 nonpoint source requirements, which made local projects that were consistent with the plan eligible for state and federal grant funding.

The Rouge Project ended in 2014 following the end of federal funding. The ARC continues to thrive, however, providing support to local township, village, city, county, and other public agency members for nonpoint pollution control efforts; assisting in meeting stormwater NPDES requirements; and coordinating public education and information on ways to protect and enhance water quality and related natural resources in the watershed.

The final 2013 *Rouge River Ecosystem Monitoring and Assessment Report* of the Rouge Project, prepared by Wayne County, documents the improvements in Rouge River water quality, including substantial improvements in dissolved oxygen levels and presence of E. coli compared to the previous 16 years. This comparison was based upon extensive monitoring supported under the Rouge Project.

4.2.6 Combined Sewer Overflows

DWSD's efforts to minimize CSO discharges to the Detroit River reach back to the mid-1970s when 144 level sensors were installed within the combined sewer system to develop an understanding of how the system reacted to rain events and provide insights into potential approaches for wet weather in-system storage. This was followed in the early 1980s by the installation of two sets of in-system storage inflatable fabric dams, one within the Livernois relief sewer at Ranspach Street and the other at the CSO discharge of the Hubbell-Southfield sewer into the Detroit-Dearborn channel of the Rouge River.

In response to the NPDES permit issued to DWSD in 1989, DWSD developed its initial Long-term CSO Control Plan in July 1996. The permit required the elimination or adequate treatment of combined sewer discharges at CSOs along the Detroit and Rouge Rivers. That report, submitted to the MDEQ on July 1, 1996, recommended a preferred plan, which outlined the necessary steps that DWSD would take for controlling CSOs. It reflected the fact that the collection system is very large and flow rates and directions within it vary depending on the intensity and spatial/temporal distribution of storm events. The preferred plan centered on four primary control areas: rain water control, in-system storage, additional wastewater treatment plant capacity, and end-of-pipe treatment.

The 1996 control plan was modified and updated, then resubmitted on November 30, 2001, as the Long-term CSO Control Plan for the Detroit and Rouge Rivers. The 2001 control plan was updated again in 2008. Soon after, the national financial collapse of 2008 began, and Detroit recognized that it was in the midst of a major economic crisis. The subsequent declaration of bankruptcy by

General Motors and Chrysler Corporation, two of Detroit’s largest employers, as well as adverse impacts to nearly all other employers, created depression-level unemployment. Many customers were simply unable to pay their water and sewerage bills.

As the economic crisis worsened, it became clear that Detroit lacked the resources and revenue to complete the CSO program as originally proposed. Detroit led the nation at nearly 30 percent unemployment by July 2009. Faced with rising unemployment, shrinking household income, continued loss of population, and huge revenue shortfalls, DWSD was compelled to terminate the Upper Rouge Tunnel to minimize the financial burden and worked with the MDEQ to extend the CSO control completion schedule of remaining untreated outfalls.

Finding a balance between incurring additional debt and developing a CSO control program that meets the MDEQ standard for elimination or adequate treatment, DWSD and MDEQ agreed to a revised approach that coupled stormwater flow reduction through green stormwater infrastructure (GSI) with a more affordable capital construction program. This program was implemented until Detroit was declared bankrupt and placed into receivership.

Acknowledging the ongoing significant economic hardship and continued high-burden status reflected in the 2012 financial capability evaluation, MDEQ worked with DWSD in preparing the NPDES permit that delayed major noncore CSO control construction projects until the permit reapplication, which is required by April 1, 2022. In the interim, DWSD proceeded with projects involving the rehabilitation of the Hubbell-Southfield retention treatment basin (RTB), the renovation of in-system storage gates, and completion of the Oakwood pump station and RTB. Further, the permit did include a requirement to continue progress on providing disinfection of treated discharge flows through the Rouge River Outfall by April 2019, while also focusing on the following CSO program elements:

- Reduction of stormwater flow into the combined sewer system through implementation of GSI
- The introduction of an adaptive management approach to evaluate and address the remaining future CSO controls based on information gained from:
 1. Evaluation of existing CSO projects
 2. Evaluation of new treatment technologies and real-time collection system controls
 3. More accurate and complete data on CSO discharge frequency and volume
 4. Performance results as benefits from GSI are realized
 5. Water quality assessments
 6. Any other pertinent information
- Continued monitoring and analysis of the conveyance system, CSO control elements, and flow meters during wet weather events to assess and more accurately determine the frequency, volume, and duration of CSO discharges from the outfalls along the Detroit River
- New George W. Kuhn RTB started in 2001—upgraded from original 1973 RTB

Additional details on the control plan are described in Section 4.3.4.

4.3 Current Regulations and Compliance

4.3.1 Formation of the Great Lakes Water Authority

As a part of the city of Detroit's federal bankruptcy proceedings, an historic agreement was reached between the mayor of the city of Detroit; the chief executive of Wayne, Oakland, and Macomb Counties; and Governor Rick Snyder to create the Great Lakes Water Authority. With nearly three million residents of the state relying on the DWSD to provide water and sanitary wastewater services, the agreement helped resolve Detroit's bankruptcy and assured future essential services to over a third of the state's population.

The agreement included payments by the municipalities to Detroit for a long-term lease of the regional wastewater interceptor and treatment system to the newly created GLWA, as well as a new governance for GLWA composed of two members appointed by the mayor of Detroit and one appointed from each Wayne, Oakland, Macomb Counties and one by the governor. The agreement was subsequently approved by the governing bodies of the three counties, the Detroit City Council, the State of Michigan, and the federal bankruptcy court.

On January 1, 2016, the DWSD completed the bifurcation process forming two new entities: the GLWA (operator of the regional water and wastewater conveyance and treatment facilities) and the new DWSD (responsible for the operation and maintenance of Detroit's local water and sewer infrastructure). Prior to January 1, 2016, DWSD was both the owner and operator of the regional and local systems. In 2017, the newly formed GLWA initiated a process to cooperatively develop, under the guidance of its steering committee (i.e., regional community and county customers, state regulators, and other regional system users), the *Comprehensive Regional 40-year Wastewater Master Plan* (GLWA Master Plan) for the new organization.

4.3.2 NPDES Permits

The GLWA and DWSD are jointly authorized to discharge from the WRRF under the five-year NPDES permit number MI0022802, which was issued on March 1, 2013, to the receiving waters of the Detroit River and the Rouge River, and from combined sewer overflow facilities to the receiving waters of the Detroit River, the Rouge River, and Conner Creek in accordance with effluent limitations, monitoring requirements, and other conditions set forth in the permit. This five-year joint NPDES permit expires in 2018 and the conditions of the reissued permit are under negotiation between the GLWA, the DWSD and the MDEQ. NPDES discharge requirements for the WRRF are presented in Section 4.3.6.

Table 4-2 summarizes the other 13 NPDES permits issued to first tier GLWA customers. First tier customers include county sanitary or intercounty drains established under the Michigan Drain Code as well as the City of Dearborn. The NPDES permits cover 45 outfalls of which 14 are currently served by retention and treatment basins (RTB) during wet weather overflows. Many of the 5-year NPDES permits were issued more than five years ago and have been extended as actions continue by communities and sanitary districts to separate sewers, design, construct, and evaluate RTBs, or take other actions to eliminate the discharge of untreated combined or sanitary sewers primarily during wet weather events. As indicated in Table 4-2, three NPDES were reissued during 2016 and 2017 with expiration dates in 2021. It appears that many of these projected dates for control may not be possible and alternative approaches and control dates are being evaluated.

Table 4-2. NPDES GLWA Regional System - NPDES and CSO Summary

Permittees	First Tier Member/Sewer District	NPDES Number	Facility/RTB	Effective	Expires	Status	RTB Capacity	Outfall Number	Currently Controlled/Treated? (Yes/No/Stormwater)	Receiving Surface Water
Southeast Macomb Sanitary District and 8 1/2 Mile Relief Drain Drainage District (MCPWC)	NE Wayne	MI0025453	Martin RTB	12/1/2009	10/1/2014	Extended	8.6 MG	Outfall 001 (RTB)	Yes	Lake St. Clair
Southeast Macomb Sanitary District and 8 1/2 Mile Relief Drain Drainage District (MCPWC)	NE Wayne	MI0025585	Chapaton RTB	12/1/2009	10/1/2014	Extended	28 MG	Outfall 001 (RTB)	Yes	Lake St. Clair
								Outfall 002 (RTB)	Yes	Lake St. Clair
Oakland County WRC and George W. Kuhn Drainage District	SE Oakland	MI0026115	George W Kuhn CSO RTB	5/6/2014	10/1/2015	Extended	130 MG	Outfall 001 (RTB)	Yes	Red Run Drain
Milk River Intercounty Drainage Board	NE Wayne	MI0025500	Milk River CSO RTB	3/6/2008	10/1/2009	Extended	18.8 MG	Outfall 001 (RTB)	Yes	Milk River
Acacia Park CSO Drainage District (Oakland County WRC), Beverly Hills, and City of Birmingham	EFSDS	MI0037427	Acacia Park CSO RTB	1/1/2017	10/1/2021	In Effect	4.4 MG	Outfall 103 (RTB)	Yes	Rouge River
Birmingham CSO Drainage District (Oakland County WRC), and City of Birmingham	EFSDS	MI0025534	Birmingham CSO RTB	1/1/2017	10/1/2021	In Effect	5.5 MG	Outfall 101 (RTB)	Yes	Rouge River via Luz & Nichols
Bloomfield Village CSO Drainage District (WRC), City of Bloomfield Hills, City of Birmingham, and Bloomfield Charter Township	EFSDS	MI0048046	Bloomfield Village CSO RTB	10/1/2007	10/1/2011	Extended	10 MG	Outfall 102 (RTB)	Yes	Rouge River via Luz & Nichols
City of Dearborn	Dearborn	MI0025542	RTB C4 RTB C6 RTB C7 RTB C8	7/1/2014	10/1/2016	Extended	RTB C4: 3.4 MG RTB C6: 7.9 MG RTB C7: 6.2 MG RTB C8: 7.5 MG	Outfall 001 (Will be separated by 2020)	No	Rouge River, Lower Branch
								Outfall 002 (Separated, waiting for PPC)	Storm Only	Rouge River, Lower Branch
								Outfall 003 (Will be separated by 2020)	No	Rouge River, Lower Branch
								Outfall 004 (Will be separated by 2020)	No	Rouge River, Lower Branch
								Outfall 005 (Separated, waiting for PPC)	Storm Only	Rouge River, Lower Branch
								Outfall 013 (Active, Working with MDEQ)	No	Rouge River
								Outfall 014 (Active, Working with MDEQ)	No	Rouge River
								Outfall 019 (Separated)	Storm Only	Rouge River, Lower Branch
								Outfall 020 (Separated)	Storm Only	Rouge River, Lower Branch
								Outfall 021 (Miller PS Emergency Overflow)	No	Rouge River
								Outfall 115 (RTB C4)	Yes	Rouge River
								Outfall 117 (RTB C6)	Yes	Rouge River
Outfall 106 (RTB C7)	Yes	Rouge River, Lower Branch								

Permittees	First Tier Member/Sewer District	NPDES Number	Facility/RTB	Effective	Expires	Status	RTB Capacity	Outfall Number	Currently Controlled/Treated? (Yes/No/Stormwater)	Receiving Surface Water
								Outfall 108 (RTB C8)	Yes	Rouge River, Lower Branch
City of Dearborn Heights and Wayne County Department of Environment	RVSDS	MI0051489	City of Dearborn Heights Combined Sewer Overflow RTB	10/1/2007	10/1/2011	Extended	2.7 MG	Outfall 001 (RTB)	Yes	Rouge River, Middle Branch
								Outfall U1	No	Rouge River, Upper Branch
								Outfall M13	No	Rouge River, Middle Branch
								Outfall M14	No	Rouge River, Middle Branch
								Outfall L43 (Separated)	Storm Only	Rouge River, Lower Branch
Wayne County Department of Environment, Charter Township of Redford, and City of Livonia	RVSDS	MI0051535	Redford Township Combined Sewer Overflow Retention Treatment Basin	11/1/2016	10/1/2021	In Effect	1.9 MG	Outfall 001 (RTB)	Yes	Rouge River, Upper Branch
								Outfall U2 (to be controlled by 2025)	No	Ashcroft-Sherwood Drain
								Outfall U3 (to be controlled by 2025)	No	Rouge River, Bell Branch of Upper Branch
								Outfall U4 (to be controlled by 2025)	No	Rouge River, Bell Branch of Upper Branch
								Outfall U5 (to be controlled by 2025)	No	Rouge River, Bell Branch of Upper Branch
								Outfall U9 (to be controlled by 2025)	No	Rouge River, Bell Branch of Upper Branch
								Outfall U10 (to be controlled by 2025)	No	Rouge River, Bell Branch of Upper Branch
Outfall U11 (to be controlled by 2025)	No	Rouge River, Bell Branch of Upper Branch								
City of Inkster	RVSDS	MI0051837	City of Inkster/City of Dearborn Heights Combined Sewer Overflow	10/1/2007	10/1/2011	Extended	n/a	Outfall 011 (to be controlled by 2025)	No	Rouge River, Lower Branch via Butler Drain
Wayne County Department of Environment and City of Inkster	RVSDS	MI0051471		10/1/2007	10/1/2011	Extended	3.1 MG	Outfall 001 (Inkster Rd CSO RTB)	Yes	Rouge River, Lower Branch

Permittees	First Tier Member/Sewer District	NPDES Number	Facility/RTB	Effective	Expires	Status	RTB Capacity	Outfall Number	Currently Controlled/Treated? (Yes/No/Stormwater)	Receiving Surface Water
			Inkster Combined Sewer Overflow Retention Treatment Basin					Outfall 10 (to be controlled by 2025)	No	Rouge River, Lower Branch
								Outfall L49 (Separated)	Storm Only	Rouge River, Lower Branch
Wayne County Department of Environment, City of Inkster, and City of Dearborn Heights	RVSDS	MI0051462	Wayne County/City of Inkster/City of Dearborn Heights Combined Sewer Overflow	10/1/2007	10/1/2011	Extended	n/a	Outfall L41 (to be controlled by 2025)	No	Rouge River, Lower Branch
								Outfall L42 (Only Inkster Portion has been Separated)	No	Rouge River, Lower Branch

4.3.3 Administrative Consent Orders in the Region

Typically, Administrative Consent Orders (ACOs) are entered into between the regulated entity and the state/federal agency where violations of permits conditions or specific rules/regulations have occurred, and the issues can be resolved between the parties short of a court action.

In July of 2011, the DWSD entered into an ACO with the MDEQ to resolve violations of the city's NPDES permit including stipulated penalties for past violations as well as for a future failure to meet the compliance program requirements outlined in the ACO. This ACO between the MDEQ and the DWSD was amended in 2012 with minor changes in compliance requirements and deadlines for completion of certain actions. In 2016, this ACO was amended a second time to incorporate the GLWA as jointly and severally liable with the City of Detroit and the DWSD for compliance with the ACO. In June 2017 the GLWA entered into an ACO with stipulated penalties for violation of its state issued air pollution control permit at the WRRF for exceeding limits for sulfur dioxide emissions. It is expected that the current ACO with respect to operations under the joint GLWA/DWSD NPDES permit will end once the new joint NPDES permit is issued in 2018.

ACOs have been used by MDEQ to successfully address overflows from separate sanitary systems (SSOs). These discharges of untreated sanitary waste are a result of variety of issues related to pump failures, pipe obstructions, valve malfunctions, infiltration of ground and stormwater, etc. Table 4-3 summarizes the most current ACOs associated with control of SSO discharges in the GLWA service area. In many cases, as shown in Table 4-4, the SSO discharges have been eliminated.

4.3.4 Long-term CSO Control Plan

In response to the requirements outlined in the NPDES permit, the DWSD developed a Long-term CSO Control Plan that addresses the control of discharges from combined sewer outfalls to the Detroit River and the Rouge River. In 2008, the Southeast Michigan Council of Governments estimated that approximately \$2.4 billion is being invested in Southeast Michigan to reduce combined sewer overflows and help improve water quality.⁹ The results of this investment include reduced sewer overflows, improved aquatic life, and local government collaboration to solve water quality issues. While tremendous achievements have been made to reduce combined sewer overflows, they are only part of the water quality solution.

The current Plan of Record is described below. The Plan of Record will be evaluated in comparison to other alternatives in Phase 2 of the wastewater master plan. The Plan of Record is presented here to document the CSO control technologies and control levels that it proposed in 2012.

The plan update reflected disposable in-line nets with disinfection for six of the seven subject Detroit River outfalls. Outfall B-07 Mt. Elliot is to be diverted to the Leib screening and disinfection facility and the existing outfall, which is monitored to document the frequency of discharge due to connections downstream to establish the level of control required.

For the six nets with disinfection facilities, the nets were grouped into two sizes: large nets having a 62.5 cubic feet per second (cfs) capacity/net and small nets having a 50 cfs capacity/net. A peak design flow rate representing 125 percent of the outfall's gravity sewer capacity was established with flow rates more than the total net capacity being screened by bar screens.

⁹ Investment in Reducing Combined Sewer Overflows Pays Dividends, Southeast Michigan Council of Governments, 2008.

Table 4-3. Administrative Consent Order Summary

Community	Sewer District	Original ACO Number	Name and Date of Most Recent ACO		Summary	Location of SSO
			Number	Date		
Allen Park	Allen Park	Consent Judgement Docket # 05-1491-CE	05-1491-CE	12/21/2005	SSOs were eliminated by constructing a pump station and storage tunnel to send flow from the City into the surcharged NWI in wet weather. PPC project plan was submitted to MDEQ for approval according to the City.	SSOs Eliminated
Center Line	Center Line	AFCO-SW01-006	AFO-SW07-001	n/a	Center Line reported SSOs in their sewerage system starting in 2000. On August 24, 2001, AFCO-SW01-006 was entered for Center Line to eliminate their SSOs at various locations and to remain within their total peak flow contract capacity. Center Line requested an increase of Contract Capacity to 13 cfs in 2014. They converted their 24-inch gravity outlet to a forcemain and installed an electric valve actuator at the SSO gate to further reduce SSOs into the Lorraine Drain. The City continues to have SSOs and did not certify the project. The City is currently working on a Corrective Action Program.	SSOs into the Lorain Drain via the Stephens Road Drain from the electronically actuated control structure located at the southeast corner of Van Dyke and Stephens Road.
Oakland County/COSDS	COSDS	DCA-OCWRC-2009-01	n/a	n/a	There were reported SSO events in 2004 and concern from MDEQ that the COSDS interceptor cannot convey wet weather flow without overflows. Oakland County Water Resources Commissioner installed a diversion to send 30 percent of flow to the Pontiac WWTP. Model has been accepted by the MDEQ. In final stages of completing minor requirements. Letter will be issued to close out DCA in December 2017.	SSOs Eliminated
Oakland County/EFSDS	EFSDS	FOA 2098	AFO-SW08-006	3/24/2009	EFSDS interceptor system and RTB regulator improvements were needed throughout the drainage district to mitigate SSOs. Phase 1 of projects include hydraulic improvements, Stonycroft Relief Sewer, and Wattles Road Linear Storage for the north evergreen interceptor. The projects were completed in July 2016, August 2016, and August 2017, respectively. Phase II Projects must be completed by 2022 and certified in 2023. EFSDS community ACOs are associated with the Oakland County ACO and will follow the same schedule.	SSOs at the Walnut Lake Pump Station Number 1 (located west of Inkster Road and north of 14 Mile Road off the Rouge River) and the 8 Mile Road and Evergreen Road intersection.
Beverly Hills	EFSDS	n/a	AFO-SW09-002	n/a		
Bloomfield Hills	EFSDS	n/a	AFO-SW09-004	n/a		
Bloomfield Township	EFSDS	FOA 2099	AFO-SW09-003	3/25/2009		
Farmington	EFSDS	n/a	ACO-SW09-005	n/a		
Farmington Hills	EFSDS	n/a	ACO-SW09-006	n/a		
Lathrup Village	EFSDS	n/a	AFO-SW09-2007	n/a		
Troy	EFSDS	n/a	ACO-SW09-006	10/1/2011		
West Bloomfield	EFSDS	n/a	ACO-SW09-005	n/a		
Clinton Township	MIDDD	ACO-SW00-002	AACO-000028	2/5/2014	Clinton Township has been working to eliminate SSOs from seven overflow pumps in two sewer districts since the early 2000s. They have completed I/I reduction projects including sewer lining, manhole rehab, and footing drain disconnection pilot projects. Clinton Township has since installed several relief sewers and corrected hydraulic restrictions and spent approximately 23.5 million in construction costs. The Township has requested additional capacity in the Macomb Interceptor. The Township shall submit Sanitary Sewer PPC Program report for District A by Feb 1, 2018 and District E by Feb 1, 2021.	SSOs at the overflow discharge points from Emergency Bypass Pump Stations PS-1, PS-2, PS-3, PS-4, PS-5, PS-6, and PS-9 in Drainage Districts A and E. See SSO map for Pump Station Locations
Fraser	MIDDD	ACO numbers are not known			The City of Fraser entered into an ACO with MDEQ in 2002. The MDEQ closed the ACO on July 19, 2016. Fraser completed the Hayes Masonic sanitary interceptor in 2011. Macomb county increased Fraser's Contract capacity, with the intent that Fraser would complete additional I/I as part of their 2016 SRF sewer rehab program and AMP.	SSOs Eliminated
Wayne County	RVSDS	FOA 2117	AACO-000031	7/29/2015	Reduce I/I and surcharging within the RVSDS. Construction projects are going on throughout the Sewer District. ACO in progress. Construction needs to be completed by Dec 30, 2022. PPC Program report due in 2023. RVSDS community ACOs are tied into the Wayne County ACO and will follow the same compliance schedule. ACO addresses City of Westland SSO points M-21, M-22, and M-25.	City of Westland SSOs at Regulators M-21, M-22, and M-25 along the Middle Rouge River. Other SSO locations within the RVSDS communities and RVSDS interceptors are unknown
City of Wayne	RVSDS	n/a	n/a	n/a		
Garden City	RVSDS	FOA 2097	AACO-000035	9/23/2015		
Northville	RVSDS	FOA 2096	AACO-000032	9/21/2015		
Plymouth	RVSDS	FOA 2095	AACO-000033	1/25/2016		
Westland	RVSDS	FOA 2114	AACO-000034	09/25/15		

Community	Sewer District	Original ACO Number	Name and Date of Most Recent ACO		Summary	Location of SSO
			Number	Date		
Melvindale	Melvindale	ACO-SW04-005	AFO-SW10-002	2/9/2010	Sanitary Pump station with one MG retention basin was constructed in 2006 to hold excess flow until pump station is capable of pumping flows into GLWA interceptor. The City was supposed to send the PPC report in 2014, and CAP in 2015 if SSO requirements were not met. There has been no action since 2014 and there have not been any SSOs in the City's system.	SSOs Eliminated
Milk River (CSO RTB)	NE Wayne	ACO-000114	ACO-000114	2/7/2014	Rehabilitation of the Milk River CSO RTB to meet dissolved oxygen water quality requirements. ACO is in progress.	None
Macomb Interceptor Drain Drainage District	MIDDD	ACO-004875	ACO-004875	9/18/2017	SSOs occurred due to December 2016 15 Mile Road Sinkhole.	SSOs Eliminated
Wayne County	NE Wayne	ACO-000115	ACO-000115	11/7/2011	Southeast Macomb Sanitary District was not able to discharge 102 cfs contract capacity through Marter Road Pump Station during several rainfall events. Upgrades were completed to Marter Road Booster Station and Kerby Road Pump Station to increase pumping capacity. Construction and PPC are complete. ACO is currently being closed.	SSOs Eliminated

Small facilities (i.e., design flow <250 cfs) are designed with netting capacities equal to or greater than the peak design flow. For these facilities, the manual bar screen is intended for emergency conditions if the nets become blinded and are unable to pass flow. For large facilities (i.e., design flow >250 cfs), the width of the facility is a key factor in determining the number of nets. For these facilities, the width of the chamber is consistent with the existing outfall width to fit the facility within the existing site, limit expansions and contractions to minimize hydraulic impacts, and limit the number of nets to a maximum of 20 per facility. Thus, some large facilities have a netting capacity less than the peak design flow. In these cases, the manual bar screen is sized to screen the peak flows and for emergency conditions. Table 4-4 below shows a summary of proposed netting facilities for the near east side area outfalls.

Table 4-4. GLWA LTCSO Plan of Record for Near East Side Detroit River

Outfall	Peak Design Flow (cfs)	Number/Size of Nets	Net Capacity
005 (B-03) McClellan/Cadillac	313	6 – L	375
006 (B-04) Fischer	1,600	20 – L	1,250
007 (B-05) Iroquois	633	10 – L	625
008 (B-06) Helen	400	6 – L	375
011 (B-09) Adair	91	2 – S	100
012 (B-10) Joseph Campau	1,238	8 – L	500

In a letter dated May 19, 2010, the MDEQ approved recommended revisions to the Long-term CSO Control Plan for the Rouge River. The specific elements of the program as approved by the MDEQ, as well as their current status, are presented in Table 4-5.

Table 4-5. GLWA LTCSO Plan of Record for Rouge River

Rouge River CSO Control Program		
Approved Program Element	Rouge River Location	Status
Completion of Oakwood Pump Station and RTB	Lower Main Rouge	Complete
Baby Creek CSO Facility Improvements	Lower Main Rouge	Complete
Carbon, Fort St. CSO Elimination	Lower Main Rouge	Complete
Hubbell-Southfield RTB Reinvestment (rehab)	Lower Main Rouge	Complete
TRC Minimization and Stream Monitoring	Lower Main Rouge	Complete
Existing CSO Facility Reinvestment (rehab)	Lower Main Rouge	Complete
Oakwood Sewers Segment 2	Lower Main Rouge	Complete
Oakwood Sewers Segment 3	Lower Main Rouge	Under reevaluation for need
Oakwood Sewers Segment 4	Lower Main Rouge	Under reevaluation for need
RRO2 Segment 1 work—WRRF	Lower Main Rouge	Complete
RRO2 Segment 2 work—Conduit	Lower Main Rouge	RRO disinfection progressive design build— in progress
Task 1 In-system Gates Reinvestment (rehab)	Upper Main Rouge	Complete
Seven First Flush Tanks (With Disposable Nets, In-pipe Disinfection)	Upper Main Rouge	Pending WSCS M&M Program, GI, and WWMP evaluation*

Rouge River CSO Control Program		
Pembroke First Flush Pilot (With Disposable Nets, In-pipe Chlorination or Alt) disinfection)	Upper Main Rouge	Pending WSCS M&M Program, GI, and WWMP evaluation
Seven Mile East First Flush Pilot (With Disposable Nets, In-pipe Chlorination or Alt Disinfection)	Upper Main Rouge	Pending WSCS M&M Program, GI, and WWMP evaluation
Glenhurst CSO PS/Diversion	Upper Main Rouge	Pending WSCS M&M Program, GI, and WWMP evaluation
Green Infrastructure Program	Upper Main Rouge	In progress

*WSCS M&M Program—West Side Collection System Monitoring and Modelling Program

*GI—Green Infrastructure Program

*WWMP—Wastewater Master Plan

The May 19, 2010, approval of the Rouge River Long-term CSO Control Plan was based on the following two reports submitted by DWSD:

- Evaluation of CSO Control Alternatives, December 15, 2009
- Supplemental Report on Alternative CSO Controls for the Upper Rouge River Outfalls, April 30, 2010

The December 15, 2009, Evaluation of CSO Control Alternatives report proposed that the three north outfalls (Pembroke, Seven Mile, and Glenhurst) be controlled separately from the 14 southern outfalls extending from Warren Avenue to McNichols Road. It was recommended that the smaller Pembroke and Seven Mile outfalls be controlled using first flush basins with disposable nets and in-pipe chlorination or alternative disinfection. Since this technology had not been previously employed, it was proposed that the facilities be constructed and piloted to demonstrate that the objectives could be accomplished prior to proceeding with the remaining facilities. The Glenhurst outfall would be addressed by redirecting flow via piping or a pump station. The 14 southern outfalls were to be controlled by the Upper Rouge Tunnel 2 (URT2), a smaller version of the originally recommended 30-foot diameter 201 million gallon storage capacity Upper Main Rouge Tunnel.

The MDEQ accepted the controls proposed for the northern outfalls, but expressed concerns over the smaller RRT2 control approach, which would reduce untreated CSO discharges from these outfalls to less than 3.2 events per year on average. The MDEQ requested that DWSD reevaluate alternatives for controlling the 14 southern outfalls.

Based on the previous paragraph, DWSD performed additional detailed analyses and alternatives evaluation, and prepared the Supplemental Report on Alternative CSO Controls for the Upper Main Rouge River Outfalls. Alternative 3B in that report was ultimately selected as the recommended control approach for the 14 outfalls extending from Warren Avenue to McNichols Road. In summary, Alternative 3B recommended the following:

- 7 first flush capture basins
- 11 in-pipe disinfection facilities (required at all outfalls not proposed to be closed)

- 11 disposable net facilities (required at all outfalls not proposed to be closed)
- Outfalls to be closed
- Conveyance from remote outfall sites by means of gravity sewers as opposed to pump stations
- Total first flush volume approximately 31 million gallons

Alternative 3B also included provision for additional peak flows up to 546 cfs from adjoining combined sewer areas in Redford and Dearborn Heights. The three outfall locations and the corresponding suburban community peak flows were estimated as follows:

- West Warren Siphon—76 cfs from Dearborn Heights
- West Chicago Siphon—345 cfs (45 cfs from Dearborn Heights and 300 cfs from Redford Twp.)
- Lyndon Brammel—125 cfs from Redford Township

A summary of the CSO control measures proposed at each of the 17 outfall locations in the Upper Main Rouge River based on the recommendations presented in the two reports are shown in Table 4-6.

Table 4-6. GLWA LTCSO Plan of Record for Upper Main Rouge River Outfalls

Outfall	NPDES ID	CSO Control Measure
West Warren Siphon	059	Diversion to Trinity-Tireman In-pipe Disinfection Facility Disposable Net Facility (eight nets, two tiers)
Trinity-Tireman	060	First Flush Capture Basin—5.9 MG In-pipe Disinfection Facility Disposable Net Facility (ten nets, two tiers)
West Chicago	061	First Flush Capture Basin—6.2 MG In-pipe Disinfection Facility Disposable Net Facility (ten nets, two tiers)
West Chicago Siphon	062	Diversion to West Chicago In-pipe Disinfection Facility Disposable Net Facility (eight nets, two tiers)
Plymouth	063	Diversion to West Chicago Siphon Bulkhead Outfall
Glendale	064	First Flush Capture Basin—2.7 MG In-pipe Disinfection Facility Disposable Net Facility (ten nets, two tiers)
Lasher-Dolson	065	First Flush Capture Basin—3.1 MG In-pipe Disinfection Facility Disposable Net Facility (eight nets, two tiers)
Schoolcraft/West Parkway	066/067	Diversion to Lasher-Dolson In-pipe Disinfection Facility Disposable Net Facility (five nets, two tiers)
Brammel (Ray)	068	Diversion to Lyndon Bulkhead Outfall
Lyndon	069	First Flush Capture Basin—3.5 MG In-pipe Disinfection Facility Disposable Net Facility (14 nets, two tiers)
Puritan	072	First Flush Capture Basin—1.3 MG In-pipe Disinfection Facility Disposable Net Facility (ten nets, two tiers)
Florence (Riverdale)	073	Diversion to Puritan Bulkhead Outfall

Outfall	NPDES ID	CSO Control Measure
McNichols/Six Mile Relief	074	First Flush Capture Basin—8.2 MG In-pipe Disinfection Facility Disposable Net Facility (40 nets, two tiers)
Glenhurst	075	Diversion to NWI Bulkhead Outfall
Seven Mile	077	First Flush Capture Basin—2.2 MG In-pipe Disinfection Facility Disposable Net Facility (ten nets, two tiers)
Pembroke	079	First Flush Capture Basin—1.5 MG In-pipe Disinfection Facility Disposable Net Facility (ten nets, two tiers)

The MDEQ's program approval also recognized a phased implementation of the Rouge River CSO Control Plan that will span 25 years and include a reassessment of DWSD's financial capacity for this plan, which will be submitted with each NPDES permit renewal application.

4.3.5 Industrial Wastewater Management

The national industrial pretreatment program was initiated by the U.S. EPA in 1983 with the promulgation of the general pretreatment regulations under the CWA. The purpose of the program was to control the discharge of industrial waste into publicly owned treatment works (POTWs) that could result in the following:

- Blocking waste transport system or creating potential for fire or explosion in the POTW
- Disrupting biological or chemical treatment in the POTW, damaging physical integrity, or causing corrosion of transport or treatment elements of the POTWs
- Worker exposure to hazardous substances at the industrial facility or those working in the POTWs
- Environmental pollution due to pass through discharge of toxic substances that are not controlled/treated within the POTWs system
- Increased cost or restrictions in management or disposal of biosolids generated at POTWs

Enforcement of the industrial pretreatment program (IPP) in Michigan is based upon rules promulgated by the state and incorporated into the NPDES permits of POTWs. POTWs typically enforce permit requirements through locally adopted ordinances regulating wastewater customers or through contracts and interagency agreements with other public wastewater collection entities. In general, an IPP requires routine monitoring and reporting of certain chemicals and characteristics of waste discharges from industrial sources.

Local POTWs may choose to regulate smaller industrial dischargers under rules that allow for less rigorous monitoring and reporting requirements for nonsignificant categorical industrial users (NSCIU) and categorical industrial users (CIU). Typically, a significant industrial user (SIU) monitors the discharge of heavy metals, and other specified hazardous substances, pH levels, oils, total volume of discharge, and other waste characteristics and provides reports to the POTW available for review by the MDEQ. Industrial facilities are subject to onsite inspections to determine compliance with standardized sampling and analysis protocols.

The GLWA summarized its IPP results in 2017 and reported by standard industrial classification code discharges to its transport and treatment system. See Table 4-7. There were 274 reporting

SIUs within the DWSD/GLWA service area in 2017, with a total average flow of 26.98 million gallons per day (mgd). This is in sharp contrast to the 56.88 mgd reported for 418 separate SIU dischargers in the same service area for 2006—a nearly 50 percent reduction in total average SIU flows and number of SIU facilities. The decline in number and volume of discharges from SIUs in the DWSD/GLWA service area most likely began just before 2007 through 2009. The SIU character and sources also changed dramatically in the period between 2002 and 2017. In 2002, there were 403 separate SIU dischargers with the top 5 percent contributing 52 percent of the total annual average of 44 mgd. Of the 20 top dischargers, 18 were manufacturing facilities. In 2017, the GLWA SIU reports indicated that the top 20 dischargers represented 59 percent of the total annual average of 27 mgd and that only 13 were classified as manufacturing, the other seven being utilities, hospitals, and transportation facilities.

Table 4-7. Annual Wastewater Flows from Significant Industrial Users

Year	Average mgd	Number of SIUs
2001	45	403
2006	56.88	418
2009	28.19	302
2012	21.93	280
2017	26.98	275

In the 2003 DWSD master plan, it was noted that industries had already begun to alter their manufacturing processes, resulting in less-polluted and lower-volume discharges through recycling water and enhanced pretreatment. While there has been an increase in recycling and reuse of process water by industries in the service area that could account for some of the reduction in flows between 2006 and 2009, a significant portion of the reduction in discharges from SIUs appears to be due to decreased production and facility closures. Between 2009 and 2017, the number of SIUs in the DWSD/GLWA service area has remained relatively stable based upon data compiled for years 2009, 2012, and 2017. Data from these same three years shows the number of reporting SIUs has ranged from 275 to 302 and the total annual discharge volumes have ranged from 21.93 mgd to 28.19 mgd. There are several thousand small (non-SIU) industrial/commercial facilities that collectively represent a small fraction of the total discharges that are not significant contributors and often are not continuous.

The number and volume of SIU discharges projected in 2003 for 2020 (41.5 mgd), in what is now the GLWA's service area, is much greater than that measured in 2018 (26.98 mgd). It is unlikely that SIU discharges will exceed 30.00 mgd anytime in the near future and the discharges from SIUs could be significantly less if there is a decrease in demand for automobiles and other manufactured goods produced in Southeast Michigan.

4.3.6 Water Resource Recovery Facility

The Great Lakes Water Authority and the City of Detroit Water and Sewerage Department are regulated by the National Pollutant Discharge Elimination System (NPDES) permit (#MI0022802) issued by the State of Michigan Department of Environmental Quality. This permit authorizes the discharge of effluent from the WRRF to the Detroit River and the Rouge River, and from combined sewer overflow facilities to the Detroit River, the Rouge River, and Conner Creek. The current permit was issued on March 1, 2013, modified on June 22, 2015, and again on January 1, 2016. The modified permit expires in 2018 and the new permit is currently under negotiations.

There are currently four monitoring points for final effluent at the WRRF: 049F, 049A, 049B and 050A, discharging through two outfalls, the Detroit River outfall (DRO 049) and the Rouge River outfall (RRO 050) as shown schematically in Figure 4-1 below.

Monthly effluent limits are summarized in Table 4-8 below. As noted, upon initiation of operation of the RRO Disinfection project, fecal coliform, total residual chlorine, dissolved oxygen and PCB limits for the RRO come into effect.

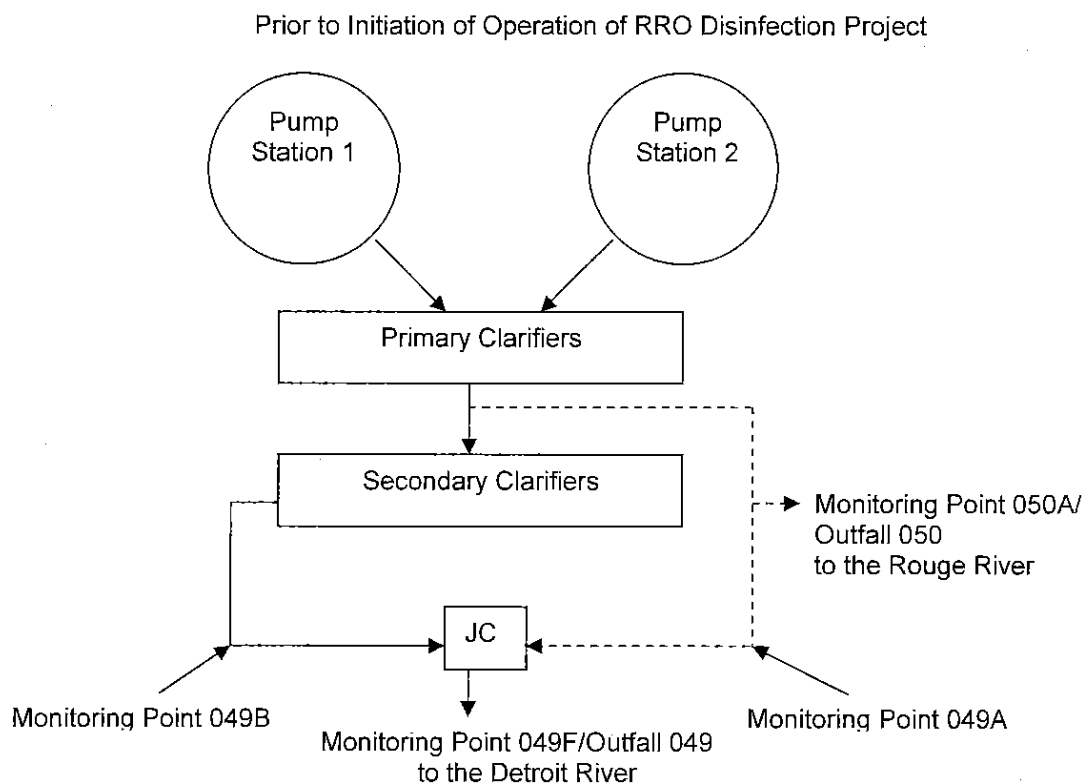

Figure 4-1. Four Monitoring Points for Final Effluent at the WRRF

Table 4-8. Current NPDES Permit Limits for WRRF Effluent

Parameter	049F	049A	049B	050A	050A*
Flow (mgd)	report	report	report	report	report
Recycled Flow (mgd)	--	--	report	--	--
Buffer Flow (mgd)	--	--	report	--	--
Fecal Coliform (cts/100 ml)	200	--	--	report	200
Total Residual Chlorine (mg/L)	0.11	--	--	--	0.038
PCBs (ug/L)	2.6×10^{-5}	--	--	report	2.6×10^{-5}
cBOD ₅ (mg/L)	--	40	25	40	40
TSS (mg/L)	--	70	30	70	70
Total Phosphorus (mg/L)					

Parameter	049F	049A	049B	050A	050A*
April - September	--	1.5	0.7	1.5	1.5
October - March	--	1.5	0.6	1.5	1.5
Ammonia Nitrogen (mg/L)	--	report	Report	report	report
Available Cyanide (ug/L)	--	--	--	89	89
Total Copper (ug/L)	--	--	--	--	--
Total Mercury (ng/L)	--	36	10	--	--
pH	6.5 to 9.0	--	6.0 to 9.0	6.5 to 9.0	6.5 to 9.0
Dissolved Oxygen (mg/L)	report	--		report	3

Notes:

Total residual chlorine is a daily maximum limit

Total Mercury is a 12-month rolling average;

Cyanide is a daily maximum limit;

Copper shall be reported daily

*Upon completion of the RRO disinfection project

The NPDES permit also sets effluent limits and reporting requirements for the Combined Sewer Overflow Retention Treatment Basin Discharges (101A, 102A, 103A, 104A, 108A and 109A) and Screening and Disinfection Facilities (105A, 106A and 107A). The RTBs and SDFs shall report flow, cBOD₅, TSS, ammonia nitrogen, total phosphorus, total residual chlorine, oil & grease, pH and dissolved oxygen and shall meet a fecal coliform limit of 400 cts/100 ml, May through October, and 1,000 cts/100 ml November through April. The total residual chlorine minimization program is designed to operate the CSO RTBs and SDFs in a manner that will provide consistent, effective disinfection while minimizing the discharge of TRC, recognizing the overall goal is compliance with the TRC Final Acute Value of 0.038 mg/L at any point in the receiving stream, unless it is determined that a higher level is acceptable.

GLWA also has limited discharge authorization for discharges from a number of combined sewer overflows assuming, to the maximum extent practicable, the available sewerage system conveyance capacity for the delivery of combined sewage to the treatment facility is utilized.

4.3.6.1 Residuals Management Program

The national standards for the use or disposal of sewage sludge is governed by 40 CFR Part 503. This includes land application standards (subpart B) and incineration standards (subpart E). The distribution and disposal of pellets from the Biosolids Drying facility are also governed by the 503 regulations. GLWA is authorized to land apply bulk biosolids or prepare bulk biosolids for land application in accordance with the Residual Management Program approved in April 2008 including all modifications in accordance with the Michigan Administrative Code (Part 24 Rules)

4.3.6.2 Air Permit

In accordance with the Clean Air Act (Part 55 of Michigan Act 451) GLWA currently operated under a Title V air permit which addresses air emissions from Complex I and Complex II incinerators, the Biosolids Drying Facility, as well as four boilers, 17 emergency generators, incinerator ash storage and conveying systems, lime storage operations and the lime pad, all located at the treatment plant site. New, more stringent emissions guidelines for Sewage Sludge Incinerators (SSI) recently became effective in March, 2016. As a result, GLWA decommissioned the six Complex I incinerators (and replaced with the Biosolids Drying Facility) and made

significant upgrades to the eight Complex II incinerators to meet the emissions limits in *40 CFR Part 62 Federal Plan Requirements for Sewage Sludge Incineration Units Constructed on or Before October 14, 2010*.

Emissions from the Complex II incinerators are controlled through a venture scrubber followed by an impingement tray wet scrubber and mist eliminator. Improvements included an upgraded impingement tray scrubber followed by a new venture scrubber and mist eliminator. Treated exhaust from the incinerators exhaust to a flue (stack). Flues for incinerators 7-10 are enclosed in tall stack II and flues for incinerators 11-14 are enclosed in tall stack III. Emissions from BDF include a three-stage impingement tray scrubber followed by a regenerative thermal oxidizer and a packed tower liquid counter flow scrubber. Emissions from the recycle bin are controlled with a fabric filter collector.

4.3.7 Green Stormwater Infrastructure

As part of Adaptive Management and the Green Stormwater Infrastructure (GSI) Initiative, Part I, Section a.15.d.9 of the NPDES permit requires alternative control of stormwater runoff from new development and redevelopment (that would otherwise be conveyed to combined sewers) to help reduce the volume and frequency of untreated CSO discharges. To address this requirement, the City of Detroit has prepared a postconstruction stormwater control ordinance that will be presented to Detroit City Council for adoption. In addition, the stormwater drainage charge and credit programs that levy charges to address runoff from impervious surfaces are expected to result in considerable stormwater flow reduction to the combined sewer system. Further, the City of Detroit has undertaken a review of the existing city codes to identify and remove barriers to GSI practices that will be required by proposed postconstruction stormwater management regulations or incent the creation of multifunctioning landscapes within commercial/industrial developments. Included as Appendix II, is the DWSD submittal dated April 1, 2017, addressing the permit requirement for stormwater control for new development and redevelopment, inclusive of a procedure and schedule for implementation.

While GLWA focuses on operation of the regional systems to maximize treatment of wet weather flows introduced to the combined sewer system, DWSD is focused on reducing or eliminating wet weather flows from the combined sewer system where feasible. To accomplish this, DWSD is fully committed to implementing GSI.

DWSD believes that implementation of effective GSI strategies will result in significant reduction of stormwater into combined sewers. The sheer number of completed and planned building demolitions within the subject tributary area have significantly changed imperviousness and hydrology since the preparation of the Long-term CSO Control Plan for Detroit River outfalls. The potential for additional stormwater reduction is expected to be even more significant through the adoption of the new stormwater ordinance and implementation of the drainage charge and credits programs in the city of Detroit.

4.3.8 Municipal Separate Storm Sewer Systems (MS4)

Under the amendments to the CWA in 1987 that regulated stormwater discharges from municipal separate storm sewer systems, the U.S. EPA, through the states, required that stormwater discharges from MS4s be permitted under the NPDES. The NPDES program for stormwater, at first, required that MS4s implement the six minimum control measures (MCMs) to the maximum extent practicable. These MCMs include:

1. Public outreach and education

2. Public involvement
3. Postconstruction runoff control (new development and redevelopment best management practice requirements)
4. Pollution prevention and good housekeeping (municipal operations)
5. Construction site runoff control
6. Illicit discharge detection and elimination

The NPDES MS4 program was separated into Phase I (communities greater than 250,000 persons or groups of communities comprising a municipal region greater than 250,000 persons) and Phase II (communities with fewer than 250,000 persons). Phase I was implemented beginning in 1990 and Phase II began in 2003. The NPDES permits had five-year cycles, with additional requirements added to the permits during renewal if receiving water impairments continued or were detected.

4.3.9 Total Maximum Daily Loads (TMDLs)

The U.S. EPA's CWA Section 303(d) program assists states, territories, and authorized tribes in submitting lists of impaired waters and developing a TMDL—the maximum load of a pollutant that can enter a receiving water from all sources that will not result in the receiving water being impaired. The TMDL is to take into account naturally occurring sources and then determine—through monitoring, modeling, and other best available science—the maximum load of a specific pollutant that those controllable discharge sources can contribute each day that will not result in impairment of the receiving water.

The TMDLs are amendments to the water quality control plans for the receiving waters. Water quality control plans define the beneficial uses and water quality criteria necessary to achieve or maintain the uses of those receiving waters. These water quality control plans are the defining documents for a receiving water that are used to set NPDES permit conditions. If receiving waters are impaired as defined in that water body's water quality control plan, then, under Section 303(d) of the CWA, the U.S. EPA, through state action, has the option to amend the water quality control plan with a TMDL. The establishment of many of these TMDLs in Southeast Michigan was accelerated due to litigation by third parties that believed adequate response actions were taking too long. In some parts of the U.S., TMDLs have been adopted and loads are being incorporated into NPDES permits for stormwater and wastewater. This is changing stormwater NPDES permits from a maximum extent practicable standard (i.e., a technology-based effluent limit standard) to a mass loading or water quality-based effluent limit standard.

4.4 Future Regulatory Compliance Landscape

The regulatory compliance history and status described in sections 4.2 and 4.3 demonstrate the constantly evolving and adaptive nature of clean water policy implementation at the federal, state, and local level. Appropriately, adaptive management practices serve an important role in driving progress towards water quality goals, while providing the flexibility needed to adjust to changing economic conditions, technological advances, compliance obligations, or jurisdictional responsibilities. This section describes recent developments in clean water policy implementation, potential future regulatory requirements, and other future compliance options that are being considered in the development of the GLWA service area wastewater master plan.

4.4.1 Regional Approach to Achieving Clean Water Goals

Following the City of Detroit's agreement to the long-term lease of its sewerage and water supply system to the GLWA, and subsequent approval of the GLWA Articles of Incorporation under Michigan PA 233 of 1955 by the three counties and the city of Detroit, the GLWA became the lease holder (owner) of the sewerage and water supply system and the DWSD became the operator of the wastewater collection system and water distribution system in the City of Detroit. As owners and operators under state and federally delegated pollution control laws, the GLWA and the DWSD are jointly responsible for meeting permitting and related ACO's requirements under a joint NPDES permit.

Including the three counties, with the city of Detroit, as part of the governance of the GLWA has been a major first step in building a consensus on regional wastewater master planning and coordinated achievement of water pollution control goals based on holistic planning principles. However, major work remains to fully integrate regional efforts and compliance strategies to achieve the various state water quality compliance program requirements across the GLWA service area.

Communities or sanitary wastewater districts (operating under the Drain Code) with contracts with the GLWA for wastewater services have separate obligations for obtaining construction permits and/or NPDES discharge permits for facilities each owns and/or operates. There are currently 13 separate NPDES permits, in addition to the joint permit for GLWA/DWSD, with four wastewater drainage districts and the cities of Dearborn and Inkster encompassing a total of over 30 outfall discharges. Most of these discharges involve retention and treatment of wet weather CSOs.

These multiple permits and related administrative orders of consent impede local efforts to integrate long-term planning and implementation for a comprehensive wastewater management system for the region encompassed by the GLWA service area. Further complicating planning and operation of integrated comprehensive wastewater management for the region are state/federal NPDES requirements for industry and public agencies for the regulation of stormwater and related nonpoint pollution sources.

Consolidation of all point source discharges into a single, comprehensive permit, regional coordination of nonpoint/stormwater programs, and/or adoption of the U.S. EPA's Regional Planning Framework as implemented in other areas of the country have all been considered as approaches to better coordinate and integrate regional efforts to achieve the desired outcomes identified in Section 2.6.

4.4.2 Consolidation of Point Source Discharge Permits (Single Regional NPDES Permit)

The GLWA provides broad authority for two or more municipalities to join together for the purpose of managing all aspects of water or wastewater facilities¹¹. Nothing within Act 233 precludes the GLWA from entering into new expanded agreements. Public entities, currently contracted GLWA customers, could enter into agreements similar to one between the GLWA and

¹¹ State of Michigan Legislature. Excerpt Michigan Natural Resources and Environmental Protection Act Michigan Legislature - Act 233 of 1955, Municipal Sewage and Water Supply Systems. 124.282 Incorporation of authority by municipalities; purpose; adoption of articles of incorporation; endorsement; territory; publishing and filing articles of incorporation; effective date; presumption of validity. (On line accessed 4/12/2018). Available [http://www.legislature.mi.gov/\(S\(pg0ziiul1kqfrof4vry02sn\)\)/mileg.aspx?page=getObject&objectName=mc1-124-282](http://www.legislature.mi.gov/(S(pg0ziiul1kqfrof4vry02sn))/mileg.aspx?page=getObject&objectName=mc1-124-282)

the city of Detroit, such that the GLWA could become a sole or joint owner/operator of all sanitary transport and treatment facilities currently served by the GLWA regional system. New legal arrangements detailing ownership; financial obligations for operation; and capital costs, including debt responsibilities, general liability, and related issues between the GLWA and each primary customer (i.e., municipality and sanitary wastewater district) would need to be negotiated and agreed upon.

While the provisions of Article Three in the GLWA Articles of Incorporation¹² would not exclude broadening the scope of the GLWA to include other facilities, changes embodying the new legal arrangements would need to be incorporated into a revised document submitted to and approved by the participating local units of government. However, if the operation and ownership of treatment and transport systems remained separated as they are now between the GLWA and the DWSD, the issuance of a single regional NPDES permit would still be problematic.

Although this option appears to have potential to consolidate required permits, it is not very attractive as a short-term approach since it would require extensive time to negotiate and resolve the interagency funding and legal responsibilities of the public entities involved. It is more complex than options in past negotiations of the current GLWA lease arrangement with the city of Detroit and the three county/city agreement on the operation of the GLWA that was facilitated through the U.S. bankruptcy court.

The public entities currently part of the GLWA as well as its public wastewater service customers could negotiate an entirely new alternative approach to the management of sanitary wastewater to achieve the preferred outcomes identified in this plan. Under this new approach, a single regional governmental entity, such as an expanded GLWA, could have the technical and financial resources and authority to implement integrated regional responses to state and federal mandated requirements that could be more cost effective and efficient.

This new approach would require state legislation. If consensus among the local governmental entities affected could be achieved for governance under such a new regional authority, bipartisan state legislative support for such a new law is likely, given the collective political power of the region. The broad legislative support and quick passage of the Watershed Alliance legislation (Act 451 of 1994) at the urging of Southeast Michigan's Rouge River communities is an example of how consensus among diverse communities in Southeast Michigan can result in bipartisan support for enabling state legislation.

4.4.3 Coordination of Nonpoint Source (Stormwater) Water Pollution Control Programs

In response to a growing recognition that control of nonpoint sources of water pollution was an essential component in achieving water quality standards and responding to rapidly expanding state and federal programs for stormwater regulation, local communities within the Rouge River watershed proposed a then-unique watershed approach to stormwater management. The watershed approach to stormwater management was established by the Rouge River Watershed

¹² Articles of Incorporation of Great Lakes Water Authority (Excerpt)

Article 3 Purpose

The Authority is incorporated for the purpose of acquiring, owning, leasing, improving enlarging, extending, financing, refinancing, and operating a water supply system and a sewage disposal system, including a stormwater collection and treatment system, or a combination of such systems, and for exercising any of the powers of the authority under these articles and for purposes authorized under Article 7, Section 28 of the Michigan Constitution, the Act (Act 233 of 1955) and other Michigan law.

Local Management Assembly that included three counties and 38 local communities under memorandum of agreement. The communities and counties formally established the Alliance Rouge Communities following the passage of Act 451 of 1994¹³, and the ARC was used by Wayne County to administer stormwater management demonstration projects implemented by governmental agencies and not-for-profit organizations using Rouge Project federal funds and local matching dollars. In 2003, Michigan initiated a watershed-based stormwater permit option to meet federal stormwater permit requirements and the ARC members sought coverage using the results of the federally and locally funded subwatershed plans and demonstration projects.

Unfortunately, Michigan's 2003 watershed-based stormwater permit program encountered implementation issues between the state and particularly the public agency members of the ARC. In 2008, a new general stormwater permit was issued by the state. Eventually, 73 public entities in Southeast Michigan filed for contested hearings to resolve disputes involving both permits. Concurrently, there was litigation in state court concerning the state-issued stormwater permits. Michigan issued new stormwater permit requirements in 2016 following federal guidelines that did not include a watershed-wide approach. The contested hearings involving the 2003 and 2008 stormwater permits were never resolved.

Despite this, the current ARC has over 40 full members representing 95 percent of public entities eligible for membership in the three counties and a number of associate members. The ARC still performs the function of assisting member organizations in meeting stormwater permit requirements and coordinates other cooperative efforts and funding to improve the water quality, riverine wildlife habitat, and recreational benefits within the Rouge River watershed. Without question, this voluntary association of local governments, public educational institutions, and nonprofit partners has provided a model for a comprehensive, coordinated approach to the control of nonpoint sources of pollution. The cost savings and efficiencies in cooperative approaches compared to individual, compartmentalized efforts have been substantial. Most importantly the results have demonstrated how, by working together, substantial improvements in the quality and uses of the Rouge River have been achieved in a cost-effective manner more so than working alone.

The ARC model could be effectively applied to the remaining portions of the GLWA service area not part of the Rouge River watershed without any change to existing laws or regulations. As a minimum, to establish a watershed alliance under the state statute, a watershed plan, a map identifying the watershed boundaries, and a list of participating governmental units would need to be developed.

Since watershed alliances under state law are voluntary, only communities that determine a cooperative stormwater management program to be beneficial, would join together. Communities, like Detroit, in which virtually all stormwater runoff finds its way to the city's combined sewer and treatment system would likely not join a watershed alliance. Those current customers of the GLWA that have runoff and stormwater discharges to the Clinton River or to Lake St. Clair may find using the RPO model valuable in addressing nonpoint and stormwater pollution sources and meeting state/federal permit requirements.

¹³ State of Michigan Legislature. Excerpt Michigan Natural Resources and Environmental Protection Act Michigan Legislature - Act 451 of 1994. 324.31202 Watershed Alliance. (On line accessed 3/13/2018). Available [http://www.legislature.mi.gov/\(S\(oliisfrok44feol3pco3pwyr\)\)/mileg.aspx?page=getobject&objectname=mcl-324-31202](http://www.legislature.mi.gov/(S(oliisfrok44feol3pco3pwyr))/mileg.aspx?page=getobject&objectname=mcl-324-31202)

4.4.4 U.S. EPA Integrated Planning Framework

In response to the increasing costs of controlling discharges from CSOs, SSOs, and MS4s, public entities subject to these regulatory programs requested that the U.S. EPA consider an alternative approach to the siloed enforcement mechanisms that had been traditionally employed. The utilities claimed that investing in CSO and SSO controls may cost more for each pound of pollutant load removed than if they were to implement MS4 controls; therefore, they sought a more integrated and holistic approach to prioritizing receiving water quality improvement efforts across all compliance requirements.

In 2011, the U.S. EPA announced an initiative to develop an integrated approach to more holistically address the various CWA compliance requirements. The U.S. EPA October 27, 2011, memorandum titled *Achieving Water Quality through Integrated Municipal Stormwater and Wastewater Plans* acknowledged that many local governments face difficult financial conditions in meeting all CWA obligations and outlined a framework by which local governments could prioritize their stormwater and wastewater investments in a manner that maximizes water quality gains, including taking advantage of green stormwater infrastructure practices.

In June of 2012, the U.S. EPA published the final *Integrated Municipal Stormwater and Wastewater Planning Approach framework*. The Integrated Planning Framework (IPF) states that this approach does not reduce the requirements of the CWA, nor does it extend the time for compliance. The framework does, however, encourage communities to focus resources on the most apparent needs across enforcement mechanisms in order to get the most benefit for investments in capital improvements, operation, and maintenance.

While neither lowering water quality requirements nor extending compliance deadlines, according to the U.S. EPA, this integrated planning framework is intended to provide flexibility to NPDES permittees in addressing their most pressing water quality improvement needs for municipal wastewater and stormwater management. The following summary of overarching principles, guiding principles, and key elements have been identified as guidance by the U.S. EPA for municipalities and communities who chose to implement an integrated planning approach.

Overarching Principles

- Maintain existing regulatory standards that protect public health and water quality.
- Allow a municipality to balance CWA requirements in a manner that addresses the most pressing public health and environmental protection issues first.
- Responsibility to develop an initial integrated plan rests with the municipality
- The U.S. EPA and/or State will determine appropriate responses, including developing requirements and schedules in enforceable documents.
- Innovative technologies, including green infrastructure, are important tools that can generate multiple benefits, and form the foundation for integrated plans.

Guiding Principles

- Reflect state requirements and planning efforts and incorporate state input on priority setting and other key implementation issues.

- Meet water quality standards and other CWA obligations by utilizing existing flexibilities in the CWA and its implementing regulations, policies, and guidance.
- Maximize the effectiveness of funds through analysis of alternatives and the selection and sequencing of actions needed to address human health and water quality-related challenges and noncompliance.
- Evaluate and incorporate, where appropriate, effective sustainable technologies, approaches, and practices, particularly including green infrastructure measures, in integrated plans where they provide more sustainable solutions for municipal wet weather control.
- Evaluate and address community impacts and consider disproportionate burdens resulting from current approaches as well as proposed options
- Ensure that existing requirements to comply with technology-based and core requirements are not delayed.
- Ensure that a financial strategy is in place, including appropriate fee structures.
- Provide appropriate opportunity for meaningful stakeholder input throughout the development of the plan.

Integrated Plan—Key Elements

- Description of the water quality, human health, and regulatory issues to be addressed in the plan
- Description of existing wastewater and stormwater systems under consideration and summary information describing the systems' current performance
- Process that opens and maintains channels of communication with relevant community stakeholders in order to give full consideration of the views of others in the planning process and during implementation of the plan
- Process for identifying, evaluating, and selecting alternatives and proposing implementation schedules
- Measuring success—As the projects identified in the plan are being implemented, utilize a process for evaluating the performance of projects identified in a plan, which may include evaluation of monitoring data, information developed by pilot studies, and other studies and other relevant information.
- Improvements to the plan

The U.S. EPA provides additional guidance for implementation of the integrated plans once they are developed. They recommend that the plans be implemented through incorporation into the NPDES permits of the respective communities/utilities or through an enforcement action such as administrative or court decrees issued by consent.

The IPF aligns well with the GLWA service area's complex regulatory landscape and goals to achieve water quality objectives through holistic, watershed wide, and receiving water quality-based approaches. Applicable elements of the IPF for the GLWA service area include:

- WRRF improvements to meet future anticipated NPDES requirements
- Combined Sewer Overflows
- Sanitary Sewer Overflows
- Capacity Management and Operation and Maintenance (CMOM)
- Long Term Operation and Maintenance
- Asset Management
- Stormwater Management
- Prioritization of all needs to achieve improvements in receiving water quality
- Affordability to establish the scheduling of improvements

The wastewater master plan is a comprehensive and regional plan structured to address many elements of the IPF. As a result, the master plan development is proceeding with the evaluation of preliminary concepts, alternatives and implementation timelines consistent with the IPF principles and the GLWA NPDES permit.

4.4.5 Great Lakes CSO Notification Policy

In January 2018 the EPA published the final rule in the Central Register regarding public notification requirements for CSOs discharged to the Great Lakes. The requirements address signage, notification of local public health departments, and other potentially affected public entities, notification to the public and annual notice. The final rule became effective on February 7, 2018. The rule is intended to provide timely notification to reduce the public's potential exposure to pathogens. The final rule includes the following:

- Develop a public notification plan by August 7, 2018
- Implementation of signage requirements by November 7, 2018
- Begin annual notice requirements by February 7, 2019 (or alternate date specified by the Director) which allows permittee time to collect data for the first year
- Initial notice be provided, as soon as possible, but no later than four hours after becoming aware that a CSO discharge has occurred
- Within seven days of becoming aware of the event, supplemental information shall be provided included the estimated volume of the discharge and the approximate time that the discharge ended.

It should be noted that untreated and partially treated CSOs are both included under this policy, one public notification for multiple discharges into the same water body is allowed and signage requirements may be waived if no public access to the water body exists.

4.4.6 Potential Future WRRF Regulations

Future permit limits are difficult to speculate, however, four areas for GLWA to monitor (and influence) over time with respect to the WRRF discharge permit include nutrient limits,

disinfection limits, emerging contaminants wet weather regulations for wastewater treatment plants. In addition, regulations related to the notification of CSOs and land application of biosolids should also be monitored. A brief description of each follows:

4.4.6.1 Nutrients

The Michigan Department of Environmental Quality has worked in partnership with US EPA for decades and continues to advance the protection of surface waters from excessive nitrogen and phosphorus pollution. In the past the focus has been on point sources, such as the GLWA WRRF, and because of those efforts point source pollution has been greatly reduced. Today, the major surface water quality issues can be attributed to discharges associated with wet weather pollution including CSOs, failing septic systems, soil erosion, farming operations and storm water. The current NPDES permit requires GLWA to achieve 0.6/0.7 mg/L TP (depending on season) on a monthly average basis from outfall 0049B, and 1.5 mg/L TP on a monthly average basis for primary effluent discharged to either the Detroit River or the Rouge River. Understand, however, that although the primary effluent limit is a monthly average, the limit should be taken as a maximum daily limit, since there may only have one day in the month when primary effluent is discharged. The current permit only requires that GLWA report ammonia nitrogen in the effluent.

For the purpose of this Master Plan we have assumed that GLWA will not receive a numeric limit for ammonia or total nitrogen within the planning period. With respect to total phosphorus, we have assumed that GLWA will endeavor to achieve the best possible TP removal within the existing infrastructure, e.g. no add-on processes will be evaluated to achieve lower phosphorus limits.

4.4.6.2 Disinfection

In recent years there has been a push to investigate the linkage (or lack thereof) of coliphage in recreational waters and incident of illness. If a linkage is found this could result in the need for significant modifications in wastewater treatment plant disinfection and monitoring, that would require the deactivation of viruses in addition to bacteria (e.g. fecal coliform, *E. coli*). GLWA should continue to be kept abreast of this issue to ensure that EPAs next steps regarding this issue are scientifically valid and will achieve environmentally beneficial results commensurate with the cost to achieve any new requirements. It is likely that the permit will move from fecal coliform as an indicator organism for bacteria to *E. coli* as has been done in other parts of the country, however this modification should not significantly impact the existing facility's ability to achieve this limit given the current disinfection technology.

4.4.6.3 Emerging Contaminants

Similarly, regulatory standards around emerging contaminants ebb and flow. Whether the issue is pharmaceuticals and personal care products, endocrine disrupters, or more recently the ubiquitous PFOS/PFOAs, GLWA should remain up to date on current trends to understand the potential impact of new regulations on the Authority's CIP.

The presence of poly- and perfluoroalkyl substances (PFAS) in water resource recovery facilities (WRRFs) has been widely reported. However, comprehensive quantitative data on specific PFAS compounds, their fate and phase partitioning through WRRF treatment processes, and the factors that control PFAS distribution in finished biosolids remain poorly understood. The absence of this fundamental information is a critical barrier for utilities to effectively manage and respond to a rapidly evolving public perception and regulatory climate related to PFAS.

Under the Safe Drinking Water Act (SDWA) EPA currently has not established maximum contaminant levels (MCLs) for PFAS chemicals. However, EPA has issued a health advisory for PerFluoroOctanoic Acid (PFOA) and PerFluoroOctaneSulfonic acid (PFOS) of 70 parts per trillion (ppt). States, therefore, have been taking the lead in PFAS regulations. Michigan's Department of Energy, Great Lakes and Environment (EGLE), has been at the forefront of state-led regulatory standards for PFAS in drinking water. In 2018 EGLE conducted a state-wide sampling program of public, school and tribal water supplies for PFAS. Subsequently, EGLE has proposed some of the most stringent limits in the nation and has established proposed MCLs for these contaminants in the single digit parts per trillion.

On the wastewater side, EGLE's Water Resources Division is investigating an Industrial Pretreatment Program (IPP) PFAS initiative to develop means for initial screening, monitoring plans, probable source monitoring and sampling and analysis protocol as well as source reduction. In addition, GLWA's most recent NPDES permit requires quarterly monitoring and reporting of PFAS in the effluent.

GLWA is an active participant in ongoing and planned research related to PFAS occurrence, fate and mass distribution in WRRFs. The complex phase behavior exhibited by PFAS, including sorption to solids, colloidal attachment, uptake at the air-water interface, and fate of volatile PFAS compounds is not well understood, yet these all play an important role in understanding the discharge from WRRFs and the nature and levels of PFAS in finished biosolids and is the subject of the upcoming Water Research Foundation (WRF) project 5031. The release of PFAS from applied biosolids has received increased public and regulatory scrutiny, and regulatory decisions made here could significantly impact how GLWA manages biosolids in the future. GLWA is currently participating in a WRF project with CDM Smith and Purdue University to better understand PFAS in biosolids. Continuing to participate in and educate regulators and the legislature on the emerging research on the fate and transport of PFAS at WRRFs, as well as the environmental and health impacts of these compounds is a critical role for GLWA in the upcoming years. In addition, encouraging source control of these contaminants before they enter the water and wastewater systems is paramount.

4.4.6.4 Blending Policy

On April 17, 2018 EPA announced it will begin a new rulemaking process to provide certainty surrounding the use of "blending" by wastewater treatment plants. They will be looking to engaging partners on the state and local level to design a rule that offers a common-sense approach to protecting public health and safely managing the nation's wastewater. GLWA should keep abreast of the ongoing discussions related to blending as it could have significant implications on future upgrades to the facility.

4.4.6.5 Residuals Management Program

As an industry, utilities are moving to produce Class A biosolids vs. Class B biosolids, as a means to increase the potential for beneficial reuse and to increase the revenue of the final product. As more Class A products hit the market, the market for Class B biosolids could diminish. Regardless, it is important for GLWA to maintain a portfolio of biosolids treatment processes and provide options, as exists today, for various outlets for biosolids. GLWA should remain abreast of biosolids regulations that could impact the economics of treatment and reuse/disposal of biosolids. These include:

- Potential update to 503 regulations to include emerging contaminants (including PFOS and PFOA)

- Land application rates of phosphorus (biosolids managed differently than manures)
- The Global Gap, which prohibits international sale of food products grown in biosolids.

Section 5

Planning Criteria

5.1 Overview

This section presents the principal planning criteria for the Wastewater Master Plan. The categories of planning criteria include the regional service area, planning period, population projections, wastewater flows and loads, contract capacities, development driven green infrastructure, hydrologic criteria, and climate change.

5.2 Regional Service Area

Figure 5-1 shows the GLWA regional service area as of October 2019. The most recent change to the service area was in June 2017 when the Western Township Utilities Authority (WTUA) began to divert flow from the Wayne County Rouge Valley Sewage Disposal District and the GLWA regional system to the Ypsilanti Community Utility Authority (YCUA).

Based on the results of Members surveys in November 2017 and July 2018, no other changes to the GLWA regional service area have been announced.

Population projections and Member survey results show residential growth driving expansion of the northern boundary of the Clinton-Oakland and Macomb Interceptor districts to the year 2060.

5.2.1 Datum

The NAD88 datum is used for GIS deliverables, the Regional Wastewater Collection System SWMM Model, the Regional Operating Plan and most graphics in this report.

The City of Detroit datum is traditionally used by operating staff at GLWA and DWSD. All construction drawings of GLWA leased facilities are based on the Detroit City Datum. To convert to NAD88 add 479.05 to the Detroit City Datum. The City of Detroit datum is cited in some parts of this report and associated technical memoranda when citing operational control points.

5.3 Planning Period and Related Time Periods

The planning period is nominally 2020 to 2060. The planning study was performed from April 2017 to October 2019.

Recommended projects from the Wastewater Master Plan were input to the FY2021 CIP in August 2019. Detailed costs by project were input to the 10-year CIP. 20-year projections from FY2021 to FY2039 were provided for GLWA financial planning. Financial projections apply to fiscal years, and FY2021 begins July 1, 2020 and ends on June 30, 2021. Capital expenditure projects were provided in detail for FY2021 to FY2030, and at a planning level to FY2039.

Operating and maintenance costs are documented for FY2017, FY2018, and FY2019.

Cost estimates are normalized to mid-2019 with ENR Construction Cost Index of 11400. In general, historic costs and future costs are presented in terms of mid-2019 construction prices. See Technical Memorandum 7 for information on cost estimating and life cycle cost analysis.

Existing conditions for model simulations was established as operating rules and condition in effect in 2018. The Regional Wastewater Collection System Model was calibrated to metering data collected from September 2017 to November 2018 and regional collection system operating data in 2017 and 2018.

Model simulations for existing conditions were performed for the period April 1 to October 31, 2018. This period was chosen due to rainfall characteristics, currency of information from the West Side Model project, and Michigan EGLE interest in this 7-month period of the year for analysis of compliance with water quality standards for recreation and aquatic species protection.

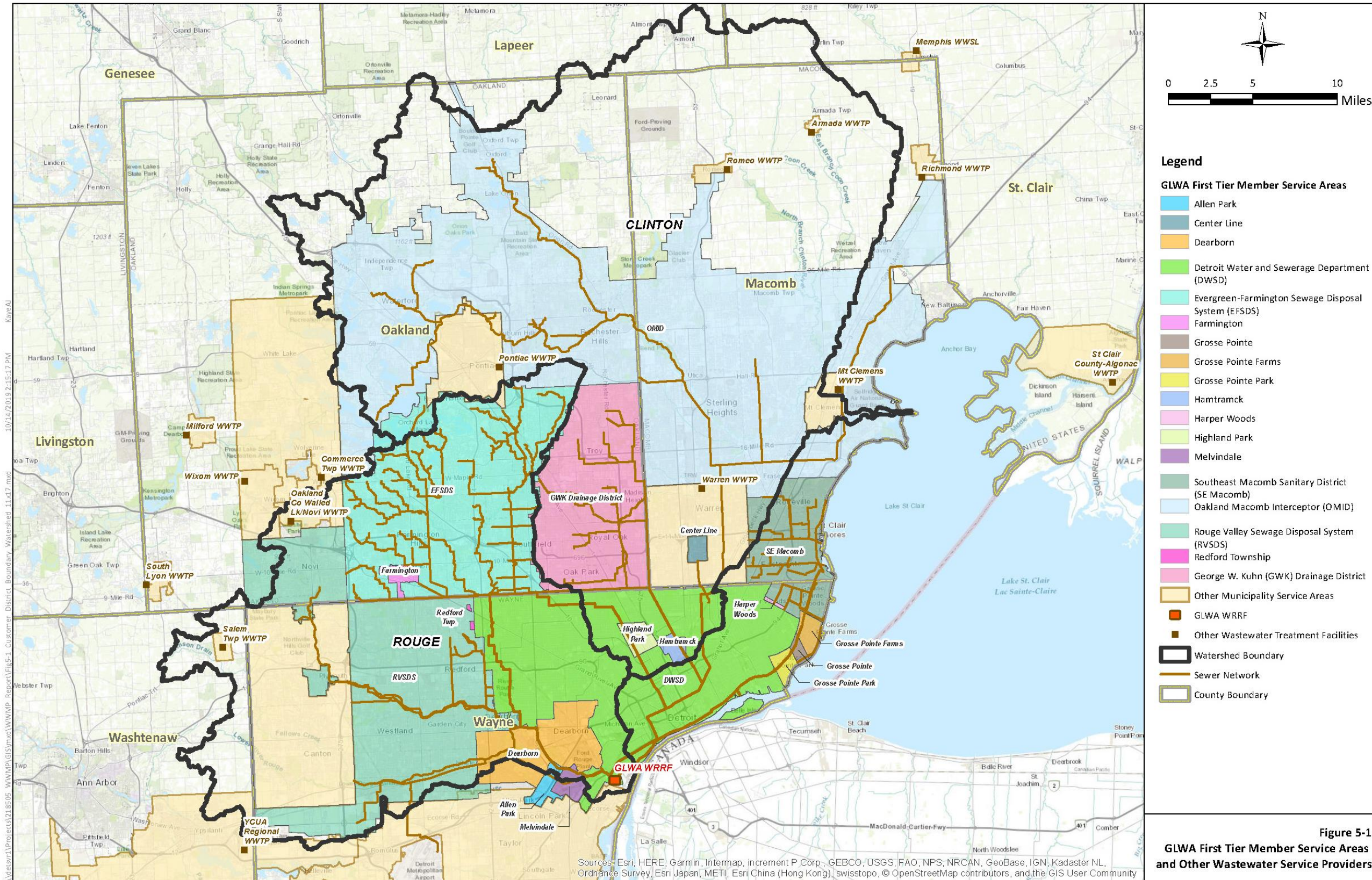

Figure 5-1
GLWA First Tier Member Service Areas and Other Wastewater Service Providers

Figure 5-1. GLWA First Tier Member Service Areas and Other Wastewater Service Providers

5.4 Population Projections

Population projections are based on the Southeast Michigan Council of Governments (SEMCOG) forecast for 2045 supplemented by GLWA Member surveys and extrapolation to the year 2060. SEMCOG prepares annual analyses of population and households by local unit of government within its 7-county planning region. The 2045 forecast was completed in June 2018.

Population forecasting, and the associated economic and demographic projections that drive population growth, is an essential component of master planning. Population change directly impacts sanitary wastewater flows (including domestic, commercial, industrial, and institutional flows) and the increase in the size of the service area (infiltration/inflow).

5.4.1 Regional Forecast Models for Population

Two regional population forecast models were reviewed to establish future projections. These models include the Woods and Poole Economics, Inc. 2018 Regional Projection (W&P) and the Regional Economics Model, Inc. (REMI model) adapted for the southeast Michigan region by the Southeast Michigan Council of Governments (SEMCOG).

5.4.1.1 Woods and Poole Economics, Inc. 2018 Regional Projection

The W&P model forecasts long-term economic and demographic parameters through the year 2050. The W&P database includes more than 900 economic and demographic parameters such as population data by age, sex, and race; employment and earnings; number of households, size, and income; and many other parameters for each county in the United States.

The W&P model projects population and other parameters using a multi-stage approach that begins with projections for the entire United States and ends with individualized projections for each county. As an intermediate step, 179 Economic Areas (EAs) are defined using sub-groups of contiguous counties to better capture regional patterns. The parameters for each EA are modified using an “export based” approach and are adjusted for individual cases if there are any other external factors for consideration. The EA economic growth assumptions are used to control the county-wide projections for population. The W&P model is revised on an annual basis with new data sources, computational techniques, and revised assumptions.

5.4.1.2 Southeast Michigan Council of Governments

SEMCOG is a regional planning partner with local member governments that consist of Livingston, Macomb, Monroe, Oakland, St. Clair, Washtenaw, and Wayne Counties. All counties, cities, villages, townships, school districts, and community colleges are invited to participate with SEMCOG. Every five years, SEMCOG releases long-term demographic and socioeconomic predictions. SEMCOG’s latest release was published in 2018 to reflect projections through the year 2045 in five-year intervals.

The REMI model is an economic/demographic model developed in Amherst, Massachusetts that was adapted for the southeast Michigan region by the University of Michigan for SEMCOG. SEMCOG made many adjustments to the REMI model based on local knowledge and input from the Regional Development Forecast Task Force. SEMCOG also generated a preliminary version of the REMI model projection in 2016 and solicited comments, which were then incorporated into the final version of the database, released in 2018. SEMCOG reviews the population projections with each

municipality and makes local adjustments to the estimates based on the information provided. The REMI model has been extensively peer reviewed and is currently used by other government agencies in Michigan such as the State Department, House Fiscal Agency, and Senate Fiscal Agency.

5.4.2 Regional Population Forecast Comparison

SEMOG's projections using the REMI model were selected for the GLWA WWMP efforts, as it is believed to be a more robust projection for southeastern Michigan due to insight from the SEMCOG members and the Regional Development Forecast Task Force. The REMI model does not force any assumptions based on past trends for the region. Changes in employment such as industry composition and labor force participation are correctly accounted for using population.

Therefore, SEMCOG's REMI model is believed to provide the most reliable forecast for the southeast Michigan region and its projections were used to estimate the population in the GLWA service area for future time periods through the year 2045.

5.4.3 Population Extrapolations: 2045 through 2060

The planning period extends 15 years beyond the 2045 SEMCOG projection. To forecast the SEMCOG populations through 2060, two different estimation techniques were completed using the 2015 to 2045 SEMCOG projections as a reference data set:

- The **Short-Term Trend Method** projects the data by assuming the future time periods will follow the same linear trend as the last five-year time interval (2040 to 2045) in the reference data set.
- The **Long-Term Trend Method** projects the data by assuming the future time periods will follow the same linear trend as the overall trend for the reference data set (2015 to 2045).

5.4.3.1 Information from First and Second Round GLWA Member Surveys

During the master planning process, two rounds of member surveys were distributed to the GLWA First Tier members to request information and feedback on their systems pertinent to the planning process. The first survey was distributed to the First Tier Members in September 2017. The survey asked questions to gain a better understanding of the members' existing systems and included topics such as general sewer system characteristics, billing meters, regulatory compliance, contract capacity, and current population. Members were also asked to provide the current population and area in their district that is currently served by GLWA.

Second-round surveys were distributed to the GLWA First Tier Members in May 2018. The second-round survey focused on potential changes in each community's wastewater system through the year 2060 such as future population, area with sewer, in-system storage, future GLWA connections, and system operation.

Trends to the year 2060 were developed individually with each First Tier Member based on the drivers of growth most applicable to the Member. The individual trend projections allowed for consideration of zoning build-out limitations, as well as in-fill redevelopment trends. Where it was not possible to develop individual projections with a Member, then a projection mid-way between the Short-Term and Long-Term projections was adopted.

Based on the Member survey and SEMCOG projections, the GLWA regional service area population is forecast to grow up to 9 percent by the year 2060:

- 2.75 million residents in 2018
- 2.77 million residents in 2025
- 2.90 million residents in 2045
- 3.06 million residents in 2060

Table 5-1 shows population projections by first and second tier Member in 5-year intervals to year 2060.

Details of the population projections, associated employment projections, and Member surveys are discussed in Technical Memorandum 2.

Table 5-1. Population Projections By First and Second Tier Member in 5-Year Intervals to Year 2060

First and Second Tier Member	Population Type	Existing 2018	Projection								
		2018	2020	2025	2030	2035	2040	2045	2050	2055	2060
Allen Park	Total	28,804	26,971	26,493	26,386	26,517	26,881	27,045	26,263	26,082	25,901
	GLWA	2,650	2,465	2,437	2,428	2,440	2,473	2,488	2,503	2,518	2,533
	Member Comments:	No Comments Provided									
Center Line	Total & GLWA	9,046	8,983	9,000	9,032	9,066	9,100	9,114	9,121	9,139	9,156
	Member Comments:	No Significant Changes Projected									
Dearborn	Total	101,785	101,185	100,886	101,248	101,938	102,644	103,684	104,724	105,764	106,804
	GLWA	92,624	92,078	91,806	92,136	92,764	93,406	94,352	95,299	96,245	97,192
	Member Comments:	Based on 7/10/18 Meeting: "Use Higher of the two Projections for the 2050 to 2060 time period"									
Detroit	Total & GLWA	657,119	638,140	631,668	640,533	657,136	675,608	694,812	714,016	733,220	752,424
	Member Comments:										
Farmington	Total	10,220	10,402	10,420	10,471	10,589	10,764	10,795	10,826	10,857	10,888
	GLWA	8,730	8,886	8,901	8,945	9,045	9,195	9,221	9,248	9,274	9,301
	Member Comments:	2015 - 2030: In fill and redevelopment					2035 - 2060: No predicted in fill or redevelopment				
Grosse Pointe	Total & GLWA	5,326	5,274	5,249	5,257	5,192	5,179	5,194	5,147	5,124	5,101
	Member Comments:	Survey was not Received									
Grosse Pointe Farms	Total & GLWA	9,476	9,248	9,058	9,031	9,112	9,062	9,111	8,955	8,905	8,854
	Member Comments:	No Comments Provided									
Grosse Pointe Park	Total & GLWA	11,555	12,183	12,095	12,024	12,017	12,094	12,201	12,308	12,415	12,522
	Member Comments:	2015 time Period: "fully developed land, estimated from 2010"									
Hamtramck	Total & GLWA	22,902	23,463	22,879	23,038	23,135	23,186	23,349	23,512	23,675	23,838
	Member Comments:	2025 time period: Wayne County Jail might close									
Highland Park	Total & GLWA	11,398	11,512	11,628	11,745	11,862	11,981	12,102	12,223	12,346	12,470
	Member Comments:	2020 through 2060: Projecting Conservative 0.2% growth due to redevelopment									
Melvindale	Total & GLWA	10,160	9,826	9,543	9,584	9,710	9,772	9,830	9,888	9,946	10,004
	Member Comments:	Not Provided									

First and Second Tier Member		Population Type	Existing 2018	Projection								
Evergreen Farmington Sewerage Disposal System (EFDS)	Auburn Hills	Total	24,732	26,081	27,123	27,294	27,524	27,838	28,084	28,330	28,576	28,822
		GLWA	1,270	1,339	1,392	1,401	1,413	1,429	1,442	1,454	1,467	1,479
		Member Comments:	No Comments Provided									
	Beverly Hills	Total	10,320	10,121	9,960	9,949	9,949	9,959	10,029	10,099	10,169	10,239
		GLWA	8,812	8,642	8,505	8,495	8,495	8,504	8,564	8,623	8,683	8,743
		Member Comments:	No Comments Provided									
	Bingham Farms Bloomfield Hills	Total & GLWA	1,049	1,026	1,028	1,013	1,041	1,069	1,080	1,080	1,080	1,080
		Member Comments:	No Comments Provided									
		Total & GLWA	4,091	4,037	4,015	4,036	4,082	4,189	4,266	4,343	4,420	4,497
	Bloomfield Township	Member Comments:	No Comments Provided									
		Total & GLWA	41,364	41,192	41,340	41,212	41,446	41,917	42,188	42,459	42,730	43,001
		Member Comments:	No Comments Provided									
	Birmingham	Total	20,516	21,162	21,525	21,732	22,000	22,261	22,251	22,241	22,231	22,221
		GLWA	14,715	15,178	15,439	15,587	15,779	15,967	15,959	16,325	16,527	16,728
		Member Comments:	Redevelopment 2050-2060									
	Farmington	Total	10,220	10,402	10,420	10,471	10,589	10,764	10,795	10,826	10,857	10,888
		GLWA	1,490	1,516	1,519	1,526	1,544	1,569	1,574	1,578	1,583	1,587
		Member Comments:	No Comments Provided									
	Farmington Hills	Total & GLWA	80,033	80,442	81,290	82,283	83,452	84,448	85,200	85,200	85,200	85,200
		Member Comments:	No Comments Provided									
	Franklin Village	Total & GLWA	3,009	2,904	2,889	2,873	2,849	2,925	2,972	3,100	3,200	3,300
		Member Comments:	No Comments Provided									
	Keego Harbor	Total & GLWA	3,039	3,094	3,069	3,078	3,116	3,092	3,148	3,204	3,260	3,316
		Member Comments:	No Comments Provided									
	Lathrup Village	Total & GLWA	3,982	3,949	3,881	3,850	3,852	3,887	3,803	3,719	3,635	3,551
		Member Comments:	No Comments Provided									
	Orchard Lake Village	Total & GLWA	2,353	2,228	2,235	2,231	2,300	2,269	2,263	2,263	2,263	2,263
		Member Comments:	No Comments Provided									
Southfield	Total	77,859	81,229	81,895	82,092	82,606	83,000	83,816	84,632	85,448	86,264	
	GLWA	70,603	73,659	74,263	74,441	74,907	75,265	76,005	76,745	77,484	78,224	
	Member Comments:	No Comments Provided										
Troy	Total	85,299	84,164	83,561	83,409	83,586	83,880	83,911	83,942	83,973	84,004	
	GLWA	15,235	15,032	14,925	14,897	14,929	14,982	14,987	14,993	14,998	15,004	
	Member Comments:	No Comments Provided										
West Bloomfield Township	Total	65,847	66,660	65,992	66,953	68,631	69,763	69,854	69,945	70,036	70,127	
	GLWA	44,906	45,461	45,005	45,661	46,805	47,577	47,639	47,701	47,763	47,825	
	Member Comments:	No Comments Provided										

First and Second Tier Member		Population Type	Existing 2018	32,706								
Southeast Macomb Sanitary District (SEMSD)	Eastpointe	Total & GLWA	32,706	32,884	31,378	30,555	30,499	30,729	30,843	29,837	29,455	31,185
		Member Comments:	No Comments Provided									
	Roseville	Total & GLWA	47,892	47,525	47,304	46,850	46,697	46,924	46,995	46,527	46,366	46,205
		Member Comments:	No Comments Provided									
	St. Clair Shores	Total & GLWA	60,208	60,986	61,936	62,734	62,595	63,308	63,276	63,244	63,212	63,180
		Member Comments:	No Comments Provided									
	Harper Woods	Total	15,108	14,598	14,387	14,368	14,400	14,602	14,682	14,762	14,842	14,922
		GLWA	14,100	13,624	13,427	13,410	13,439	13,628	13,703	13,777	13,852	13,927
		Member Comments:	No Comments Provided									
	Grosse Pointe Shores	Total & GLWA	2,532	2,447	2,409	2,440	2,499	2,539	2,555	2,571	2,587	2,603
		Member Comments:	No Comments Provided									
	Grosse Pointe Woods	Total & GLWA	15,721	15,262	15,132	15,004	14,948	14,870	15,077	14,731	14,627	14,523
		Member Comments:	No Comments Provided									
	Oakland Macomb Interceptor Drain Drainage District (OMIDDD-MIDDD)	Chesterfield Township	Total	44,986	48,356	50,892	53,011	54,034	54,674	54,721	54,768	54,815
GLWA			42,737	45,938	48,347	50,360	51,332	51,940	51,985	52,030	52,074	52,119
Member Comments:			No Comments Provided									
Clinton Township		Total & GLWA	98,523	105,493	108,546	109,376	110,395	111,416	111,937	112,459	112,980	113,501
		Member Comments:	No Comments Provided									
Fraser		Total & GLWA	14,741	15,001	15,009	15,017	15,025	15,033	15,049	15,065	15,081	15,097
		Member Comments:	No Comments Provided									
Harrison Township		Total	25,702	26,623	26,765	26,907	27,509	28,111	29,074	30,037	31,000	31,963
		GLWA	23,623	24,544	24,686	26,907	27,509	28,111	29,074	30,037	31,000	31,963
		Member Comments:	No Comments Provided									
Lenox Township		Total & GLWA:	5,463	5,522	5,913	6,647	7,258	7,359	7,322	8,011	8,390	8,768
		Member Comments:	No Comments Provided									
Macomb Township		Total	88,223	90,124	93,733	96,320	98,779	98,779	97,427	101,908	103,692	105,477
		GLWA	80,000	83,000	87,200	90,100	92,900	94,850	95,000	99,636	102,293	104,950
		Member Comments:	No Comments Provided									
New Haven		Total & GLWA	4,966	5,044	4,895	4,867	4,884	4,841	4,692	4,707	4,663	4,619
		Member Comments:	No Comments Provided									
Shelby Township		Total	73,647	78,129	81,801	82,566	83,237	83,228	83,354	83,480	83,606	83,732
		GLWA	41,629	44,498	47,880	48,601	48,998	48,992	49,066	49,140	49,214	49,288
		Member Comments:	No Comments Provided									
Sterling Heights		Total & GLWA	133,847	134,714	136,619	138,617	139,504	140,123	141,021	141,919	142,817	143,715
		Member Comments:	No Comments Provided									
Utica		Total	4,565	4,883	5,133	5,205	5,278	5,188	5,290	5,392	5,494	5,596
		GLWA	4,815	5,133	5,383	5,455	5,528	5,438	5,540	5,642	5,744	5,846
		Member Comments:	No Comments Provided									
Washington Township		Total	26,447	30,460	31,694	35,119	36,969	37,314	37,227	40,936	42,769	44,602
		GLWA	19,347	22,283	23,085	25,312	26,515	26,740	26,683	29,188	30,415	31,642
		Member Comments:	No Comments Provided									

First and Second Tier Member		Population Type	Existing 2018	Projection								
Oakland Macomb Interceptor Drain Drainage District Clinton-Oakland Sewage Disposal District (OMID-COSDOS)	Auburn Hills	Total	24,732	26,081	27,123	27,294	27,524	27,838	28,084	28,330	28,576	28,822
		GLWA	23,463	24,743	25,731	25,893	26,111	26,409	26,643	26,876	27,109	27,343
		Member Comments:	No Comments Provided									
	Clarkston Village	Total & GLWA	876	847	871	875	909	911	919	927	935	943
		Member Comments:	No Comments Provided									
	Independence Township	Total	35,074	36,918	37,471	38,298	39,174	39,782	39,922	40,062	40,202	40,342
		GLWA	17,823	18,760	19,041	19,461	19,907	20,216	20,287	20,358	20,429	20,500
		Member Comments:	No Comments Provided									
	Lake Angelus	Total	300	301	304	295	295	285	290	295	300	305
		GLWA	0	0	0	0	0	0	0	0	0	300
		Member Comments:	No Comments Provided									
	Lake Orion Village	Total	2,830	3,044	3,086	3,130	3,203	3,236	3,295	3,354	3,413	3,472
		GLWA	2,491	2,680	2,717	2,755	2,820	2,849	2,901	2,900	2,900	2,900
		Member Comments:	No Comments Provided									
	Oakland Charter Township	Total	18,176	21,032	21,822	23,887	24,858	26,004	25,924	25,844	25,764	25,684
		GLWA	9,083	10,510	10,905	11,937	12,422	12,995	12,955	12,915	12,875	12,835
		Member Comments:	No Comments Provided									
	Orion Township	Total	35,287	34,815	34,925	35,409	36,570	37,269	37,032	36,795	36,558	36,321
		GLWA	32,950	32,509	32,612	33,064	34,148	34,801	34,580	34,358	34,137	33,916
		Member Comments:	No Comments Provided									
	Oxford Village	Total	3,077	2,837	2,885	2,941	2,953	2,943	2,890	2,837	2,784	2,731
		GLWA	2,554	2,355	2,395	2,441	2,451	2,443	2,399	2,401	2,500	2,600
		Member Comments:	No Comments Provided									
	Oxford Township	Total	16,772	17,720	17,640	18,761	18,976	19,409	19,449	19,489	19,529	19,569
		GLWA	8,076	8,532	8,494	9,033	9,137	9,345	9,365	9,384	9,403	9,422
		Member Comments:	No Comments Provided									
	Rochester	Total & GLWA	13,181	14,164	14,424	14,423	14,454	14,584	14,657	15,026	15,216	15,405
		Member Comments:	No Comments Provided									
Rochester Hills	Total	73,706	75,288	76,940	77,382	78,711	79,399	79,709	80,019	80,329	80,639	
	GLWA	69,904	71,404	72,971	73,390	74,651	75,303	75,597	75,891	76,185	76,479	
	Member Comments:	No Comments Provided										
Waterford Township	Total	74,656	72,080	72,389	72,729	73,020	73,539	74,059	74,579	75,099	75,619	
	GLWA	74,656	72,080	72,389	72,729	73,020	73,539	74,000	74,000	74,000	74,000	
	Member Comments:	No Comments Provided										
West Bloomfield Township	Total	65,847	66,660	65,992	66,953	68,631	69,763	69,854	69,945	70,036	70,127	
	GLWA	20,941	21,199	20,987	21,292	21,826	22,186	22,215	22,244	22,273	22,302	
	Member Comments:	No Comments Provided										

First and Second Tier Member		Population Type	Existing 2018	Projection								
Rouge Valley (RVDS)	Canton Township	Total	92,521	99,462	101,086	106,261	110,226	112,102	114,119	116,136	118,153	120,170
		GLWA	3,945	4,241	4,310	4,531	4,700	4,780	4,866	4,952	5,038	5,124
		Member Comments:	Survey was not Received									
	Dearborn Heights	Total	59,371	61,070	60,865	61,472	62,132	62,246	62,542	62,838	63,134	63,430
		GLWA	39,790	40,929	40,792	41,198	41,641	41,717	41,916	42,114	42,312	42,511
		Member Comments:	Survey was not Received									
	Garden City	Total & GLWA	26,994	26,058	26,049	26,394	26,555	26,647	26,764	26,881	26,998	27,115
		Member Comments:	Survey was not Received									
	Inkster	Total	25,760	25,385	24,808	24,366	24,259	24,263	24,420	24,577	24,734	24,891
		GLWA	25,631	25,258	24,684	24,244	24,138	24,142	24,298	24,454	24,610	24,766
		Member Comments:	Survey was not Received									
	Livonia	Total & GLWA	94,159	92,342	91,997	92,415	92,923	93,665	94,228	94,791	95,354	95,917
		Member Comments:	Survey was not Received									
	Northville	Total	5,828	5,765	5,798	5,888	6,005	6,113	6,183	6,253	6,323	6,393
		GLWA	5,657	5,596	5,628	5,715	5,829	5,934	6,002	6,070	6,138	6,206
		Member Comments:	Survey was not Received									
	Northville Township	Total	30,306	33,921	34,771	35,292	36,157	36,282	36,886	37,490	38,094	38,698
		GLWA	171	191	196	199	204	205	208	212	215	218
		Member Comments:	Survey was not Received									
	Novi	Total & GLWA	60,458	63,966	64,801	65,638	66,609	67,061	67,417	67,773	68,129	68,485
		GLWA	54,026	57,161	57,907	58,655	59,523	59,927	60,245	60,563	60,881	61,199
		Member Comments:	Survey was not Received									
	Plymouth	Total & GLWA	8,872	9,090	9,341	9,468	9,534	9,592	9,786	9,980	10,174	10,368
		Member Comments:	Survey was not Received									
Plymouth Township	Total	27,440	28,843	29,130	29,622	30,121	30,598	30,649	30,700	30,751	30,802	
	GLWA	1,105	1,161	1,173	1,192	1,213	1,232	1,234	1,236	1,238	1,240	
	Member Comments:	Survey was not Received										
Redford	Total	47,880	45,349	44,719	44,758	44,772	45,064	45,277	45,490	45,703	45,916	
	GLWA	46,571	44,109	43,497	43,535	43,548	43,832	44,039	44,247	44,454	44,661	
	Member Comments:	Survey was not Received										
Romulus	Total	24,010	23,918	24,425	24,706	24,836	25,818	26,330	26,842	27,354	27,866	
	GLWA	2,364	2,355	2,405	2,433	2,445	2,542	2,592	2,643	2,693	2,744	
	Member Comments:	Survey was not Received										
Van Buren Township	Total	29,274	30,773	31,898	33,163	34,064	35,398	35,966	36,534	37,102	37,670	
	GLWA	7,047	7,408	7,679	7,983	8,200	8,521	8,658	8,795	8,931	9,068	
	Member Comments:	Survey was not Received										
Wayne	Total & GLWA	17,010	16,189	15,867	15,995	15,737	15,810	15,910	16,010	16,110	16,210	
	Member Comments:	Survey was not Received										
Westland	Total & GLWA	83,452	83,455	83,475	83,405	83,841	84,462	85,427	86,392	87,357	88,322	
	Member Comments:	Survey was not Received										

First and Second Tier Member		Population Type	Existing 2018	Projection								
S.E. Oakland (GWK)	Berkley	Total & GLWA	15,166	14,592	14,807	14,889	14,997	14,913	14,964	15,015	15,066	15,117
		Member Comments:	No Comments Provided									
	Beverly Hills	Total	10,320	10,121	9,960	9,949	9,949	9,959	10,029	10,099	10,169	10,239
		GLWA	1,508	1,479	1,455	1,454	1,454	1,455	1,465	1,476	1,486	1,496
		Member Comments:	No Comments Provided									
	Birmingham	Total	20,516	21,162	21,525	21,732	22,000	22,261	22,251	22,241	22,231	22,221
		GLWA	5,801	5,984	6,086	6,145	6,221	6,294	6,292	6,436	6,515	6,595
		Member Comments:	No Comments Provided									
	Clawson	Total & GLWA	11,661	11,494	11,674	11,647	11,736	11,834	11,935	12,036	12,137	12,238
		Member Comments:	No Comments Provided									
	Ferndale	Total & GLWA	20,428	20,173	20,635	20,793	20,942	21,164	21,069	20,974	20,879	20,784
		Member Comments:	No Comments Provided									
	Hazel Park	Total & GLWA	16,016	14,886	14,817	14,604	14,532	14,550	14,448	14,500	14,500	14,500
		Member Comments:	No Comments Provided									
	Huntington Woods	Total & GLWA	6,230	6,247	6,246	6,222	6,267	6,257	6,247	6,237	6,227	6,217
		Member Comments:	No Comments Provided									
	Madison Heights	Total & GLWA	30,749	29,275	29,614	29,520	29,456	29,672	29,757	29,800	29,800	29,800
		Member Comments:	No Comments Provided									
	Oak Park	Total & GLWA	30,837	30,186	29,919	29,539	29,380	29,291	29,129	28,967	28,805	28,643
		Member Comments:	No Comments Provided									
Pleasant Ridge	Total & GLWA	2,489	2,395	2,447	2,462	2,468	2,449	2,518	2,600	2,650	2,775	
	Member Comments:	No Comments Provided										
Royal Oak	Total & GLWA	59,510	59,930	60,556	60,838	60,665	61,112	61,612	62,000	62,000	62,000	
	Member Comments:	No Comments Provided										
Royal Oak Township	Total & GLWA	2,378	2,449	2,407	2,368	2,333	2,343	2,313	2,283	2,253	2,223	
	Member Comments:	No Comments Provided										
Southfield	Total	77,859	81,229	81,895	82,092	82,606	83,000	83,816	84,632	85,448	86,264	
	GLWA	7,256	7,570	7,632	7,651	7,699	7,735	7,811	7,887	7,964	8,040	
	Member Comments:	No Comments Provided										
Troy	Total	85,299	84,164	83,561	83,409	83,586	83,880	83,911	83,942	83,973	84,004	
	GLWA	70,064	69,132	68,636	68,512	68,657	68,898	68,924	68,949	68,975	69,000	
	Member Comments:	No Comments Provided										
Summation	Total	3,109,514	3,130,187	3,147,597	3,186,284	3,231,476	3,272,637	3,305,482	3,345,047	3,380,862	3,418,865	
	GLWA	2,752,672	2,756,773	2,769,676	2,799,893	2,836,706	2,873,542	2,903,855	2,939,306	2,971,592	3,006,367	

5.5 Wastewater Flows and Loads

The growth in population described in Section 5.4 is anticipated to create an increase sanitary wastewater flow to the GLWA WRRF by approximately 10 mgd by 2045 and 16 mgd by 2060.

In addition to population growth, flow projections could be influenced by other factors, including: water conservation, shifts in service population to or from other outside wastewater treatment plant providers, significant growth or shifts in industrial users, and removal of I/I in the collection system. See Table 5-2 for wastewater flow and load projections. Additional information on wastewater flows and loads is presented in Section 7 of this report and Technical Memorandum 5A.

Sanitary wastewater flow at the WRRF in the three fiscal year period ending June 30, 2019, averaged 189 mgd, and for the four fiscal year period ending June 30, 2016, averaged 202 mgd based on GLWA's Annual Wastewater Flow Balance Report.

The significance of shifts in service area population can be understood by comparing sanitary wastewater flow between 2016 and 2019. For the 3-year period ending June 30, 2016, the average sanitary wastewater flow at the WRRF was 202 mgd. For the 3-year period ending June 30, 2019, the averages sanitary wastewater flow was 189 mgd. The reduction in sanitary wastewater flow during this period was largely due to diversions of flow from the GLWA regional system to the other wastewater service providers in the region. The Clinton-Oakland District in Oakland County initiated a flow diversion of 30 percent of its annual flow to the Pontiac Water Resource Recovery Facility in 2016. The Western Township Utility Authority in Wayne County diverted a portion of its flow from the GLWA regional system to the Ypsilanti Community Utility Authority beginning in 2017. These two diversions account for approximately 10 mgd of the sanitary wastewater flow reduction to the GLWA WRRF. The City of Highland Park is making improvements in flow estimates and metering, which accounts for another 1.5 mgd of the reduction. Other reductions in sanitary wastewater flow during this period are ascribed to the increased use of low flow plumbing fixtures.

Table 5-2. Projected Influent Flow at the GLWA Water Resource Recovery Facility

Measure of WRRF Flow	Existing Flow (mgd)	2045 Flow (mgd)	2060 Flow (mgd)
Average Daily Flow	630	651 to 662	668 to 679
Maximum Day Flow	1,2571	1,299 to 1,321	1,333 to 1355
Peak Hour Flow	1,9022	1,700	1,700
Minimum Day Flow	389	376 to 400	380 to 404

¹The existing maximum daily flow represents the 98th percentile of flow from the historical 3-year dataset of FY2015 to FY2017.

²The peak hour flow recorded from the historical 3-year dataset exceeded the primary treatment capacity of 1,700 mgd.

5.6 Hydrologic Criteria

Model simulations were performed with synthetic design storms, with actual storm event data, and with continuous simulation.

5.6.1 Continuous Simulations

Continuous simulation was used for comparison of Alternatives as discussed in Section 6. Based on work performed for the GLWA West Side Model agreement was reached with EGLE that the 7-month period from April 1 to October 31 is the most sensitive for evaluation of receiving water quality impacts. The year 2018 based on recent acceptance of this period by EGLE for use on the GLWA West Side Model.

5.6.2 Design Event Simulations

Design storm hyetographs are shown in Figures 5-2 to 5-4 for Michigan EGLE requirements.

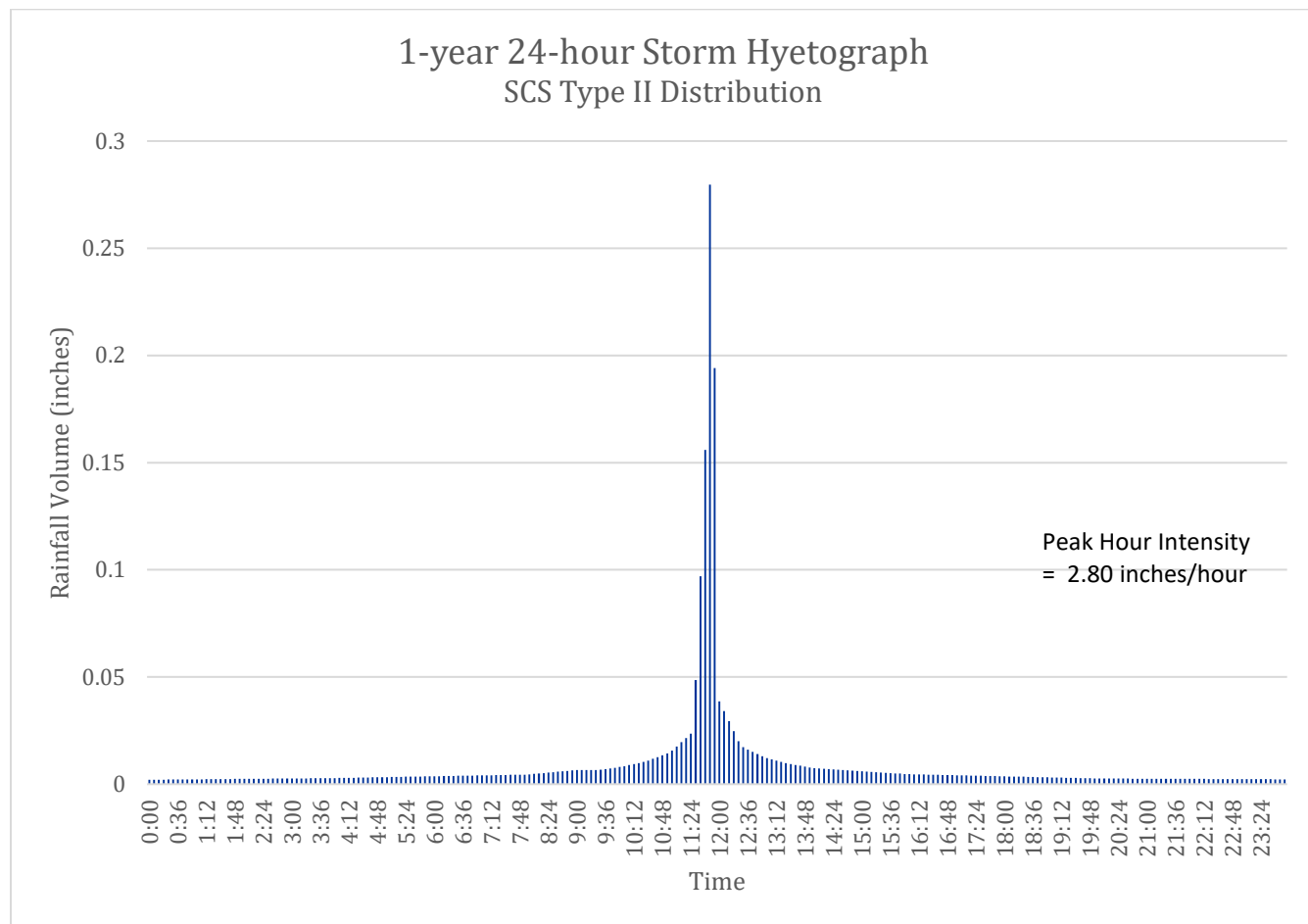

Figure 5-2. 1-Year 24-Hour Design Storm

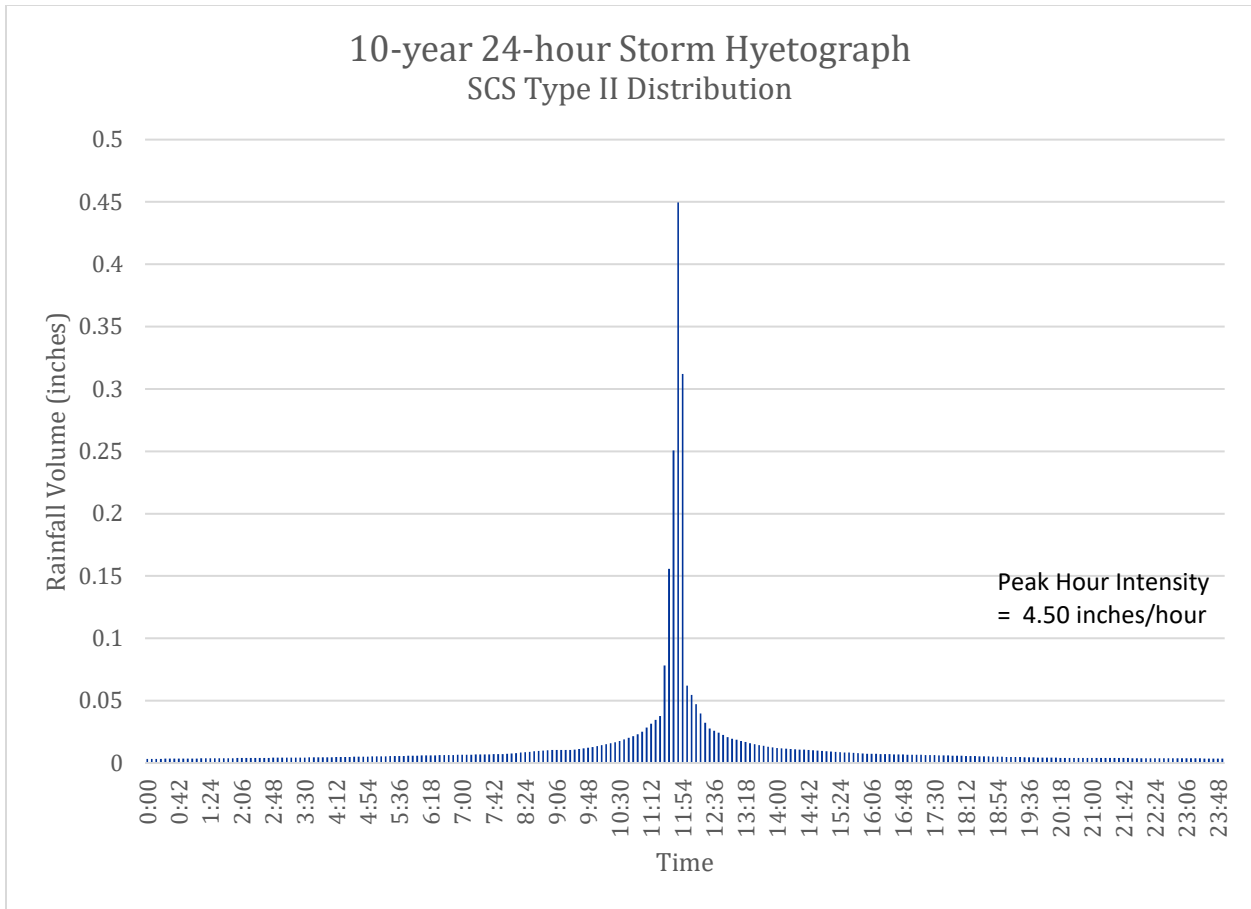

Figure 5-3. 10-Year 24-Hour Design Storm

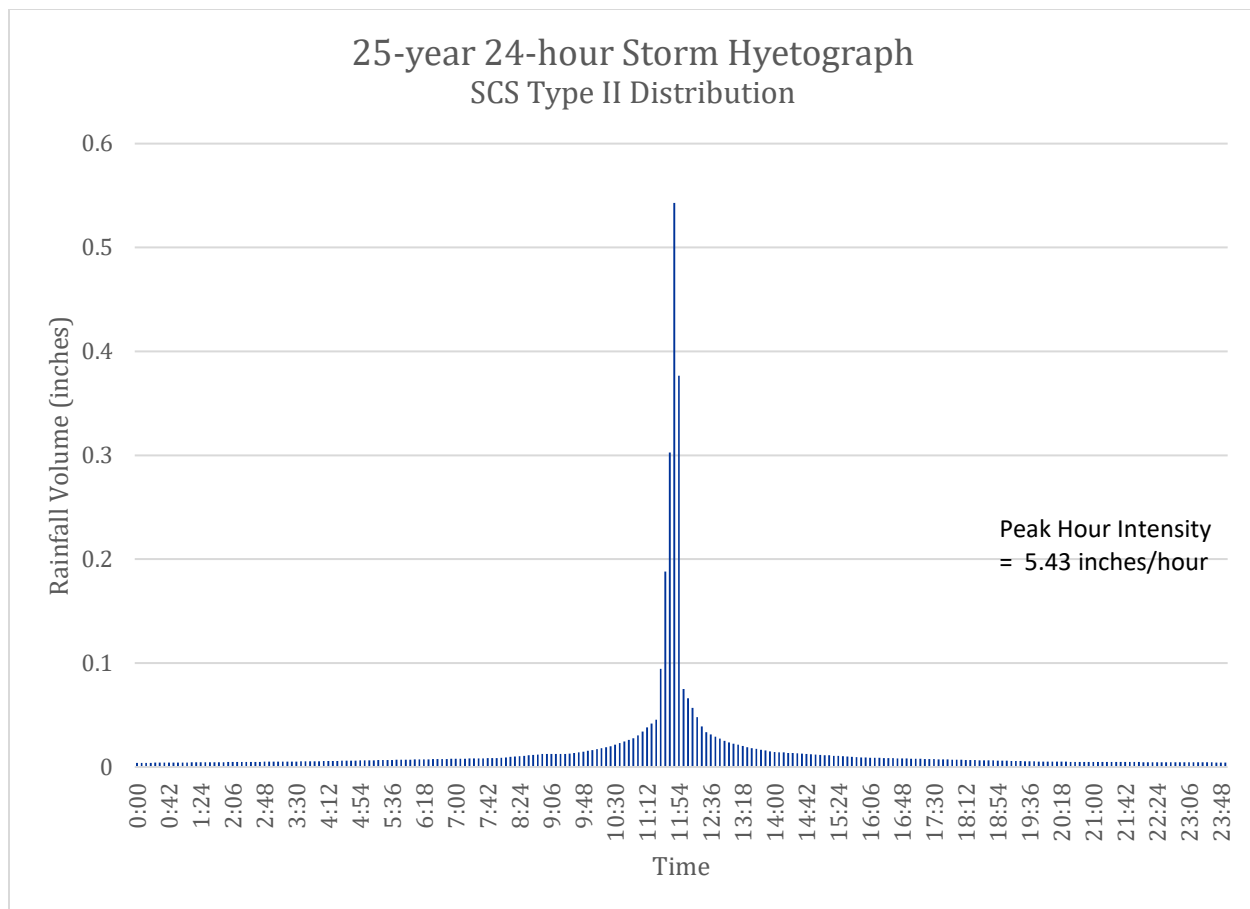

Figure 5-4. 25-Year 24-Hour Design Storm

5.7 Development Driven Green Stormwater Infrastructure

GLWA's analysis of green stormwater infrastructure (GSI) in the WWMP can be placed in a larger context of national trends in GSI analysis, implementation, and regulatory framework. Some key trends are briefly surveyed below:

- A consensus is forming within the scientific community, regulatory agencies, and the water utility industry that urban/suburban stormwater impacts are significant, and that green stormwater infrastructure is a key strategy for addressing them.
- Impacts of urban and suburban stormwater on water quality and aquatic ecosystems are well documented in the scientific and professional literature (e.g., Burton and Pitt, 2001; Schueler et al., 2009).
- A 2009 report by the National Research Council concluded that the current approach to municipal stormwater management in the United States has not yielded significant water quality improvements (NRC, 2009). The problem continues to grow in many watersheds within the United States even as progress is being made on most other sources of water

pollution. Stormwater management practices have been improved but are being outpaced by urban and suburban development trends (WEF Stormwater Institute, 2015).

- Green infrastructure and source control technologies are increasingly accepted as the best practice for reducing stormwater impacts. For example, the National Research Council has recommended low impact development, green infrastructure and on-site retention as technological best practices due to their ability to mimic natural hydrology and pollutant attenuation processes (NRC, 2009).
- Monitoring data and available analysis on the effectiveness of green infrastructure for hydrologic, hydraulic, and water quality performance is growing. In addition to a significant academic literature, the International Stormwater BMP Database is a source of both data and statistical performance analysis on the effectiveness of many green infrastructure approaches (WERF, 2016).
- Formal support for GSI has increased within the Clean Water Act regulatory framework.
 - In January 2019, the U.S. Congress amended the Clean Water Act to encourage incorporation of GSI in municipal stormwater and wastewater plans. EPA’s 2012 Integrated Municipal Stormwater and Wastewater Planning Approach Framework, incorporated into the CWA by reference, encourages permittees to “evaluate and incorporate, where appropriate, effective sustainable technologies, approaches and practices, particularly including green infrastructure measures, in integrated plans where they provide more sustainable solutions for municipal wet weather control.” (USEPA, 2012)
 - Green infrastructure is not explicitly required under federal regulations governing MS4 systems (40 CFR Part 122). However, it is seen as a best practice addressing portions of two of the six minimum control measures that are required: post-construction stormwater management and pollution prevention/good housekeeping. Current EPA guidance encourages green infrastructure as a best practice for post-construction stormwater management, provided inspection and maintenance provisions are included (USEPA, 2010). Some permitting approaches are beginning to focus more on program outcomes such as monitored stormwater management performance and receiving water quality. Some are incorporating more specific design and maintenance requirements (WEF Stormwater Institute, 2015).
 - As of 2015, 17 U.S. states and the District of Columbia had retention-based performance standards for new development and redevelopment (WEF Stormwater Institute, 2015).

Specifically, if population growth in a census tract exceeds 20 percent, then it was assumed that redevelopment would take place, and the redevelopment would trigger implementation of storm water ordinance within the jurisdiction that the growth was occurring and thereby create implementation of green stormwater infrastructure or equal stormwater controls.

5.8 Climate Resiliency

5.8.1 Detroit River Level

The Detroit River and the most downstream end of the Rouge River levels fluctuate seasonally and annually. Historic Detroit River levels are presented on Figure 5-5. Based on historic construction drawings, the criteria used in the design of facilities since the 1940's assumed a range of elevations in the Detroit River from El 91 ft minimum to El 98 ft maximum (City of Detroit datum). The Detroit River level is important as the River level impacts the capacity of the Detroit River Outfall to discharge by gravity.

The estimated capacity of the DRO and RRO to discharge as a function of River level, when both outfalls are operating concurrently, is presented in Table 5-3. The hydraulics are quite complex because of the flow paths they share when both outfalls are in operation. When both outfalls are in operation, the intent is to preferentially discharge secondary effluent to the Rouge River and primary effluent to the Detroit River. This is accomplished by modulating control gates to maintain the desired level of primary effluent discharged while preventing submergence of the primary clarifier weirs. The primary clarifier weirs are at an elevation well below that of the secondary clarifier weirs (100.50 ft vs 104.00 ft). The capacity of the DRO is well over 900 mgd when operating independently. It should be noted that the spring/summer of 2019, represented historically high Great Lake levels and Detroit River levels, rivaling historic high elevations of 1986. On May 1, 2019, a peak hour flow of 1,680 mgd was discharged (694 mgd through the DRO and 986 mgd through the RRO) when the Detroit River level at Zug Island was reported at 98.5 ft.

Not only are the WRRF outfalls impacted, but the discharges from the Conner Creek RTB, Baby Creek SDF, and St Aubin SDF can be impacted, and increased river levels also increase the infiltration into the system as groundwater levels increase and the river backs up into the system through the CSOs.

Prevailing winds from the southeast can also increase the Detroit River elevations as winds and changes in atmospheric pressure push water in Lake Erie towards the mouth of the Detroit River creating a seiche phenomenon which increases the water surface elevation at one end of the lake with a corresponding drop in level at the other end.

The Rouge River water surface elevation responds to rain events. The Rouge River will rise several feet in major storm events upstream of the concrete channel section.

High river elevations create hydraulic conditions on CSO outfall backwater gates that increase in-system storage during rain events when there are high river levels. Due to the significance of river-induced in-system storage and potential river inflow, the Regional Wastewater Collection System Model includes computational tools to account for river level and the impact on hydraulic grade calculations within the sewer system.

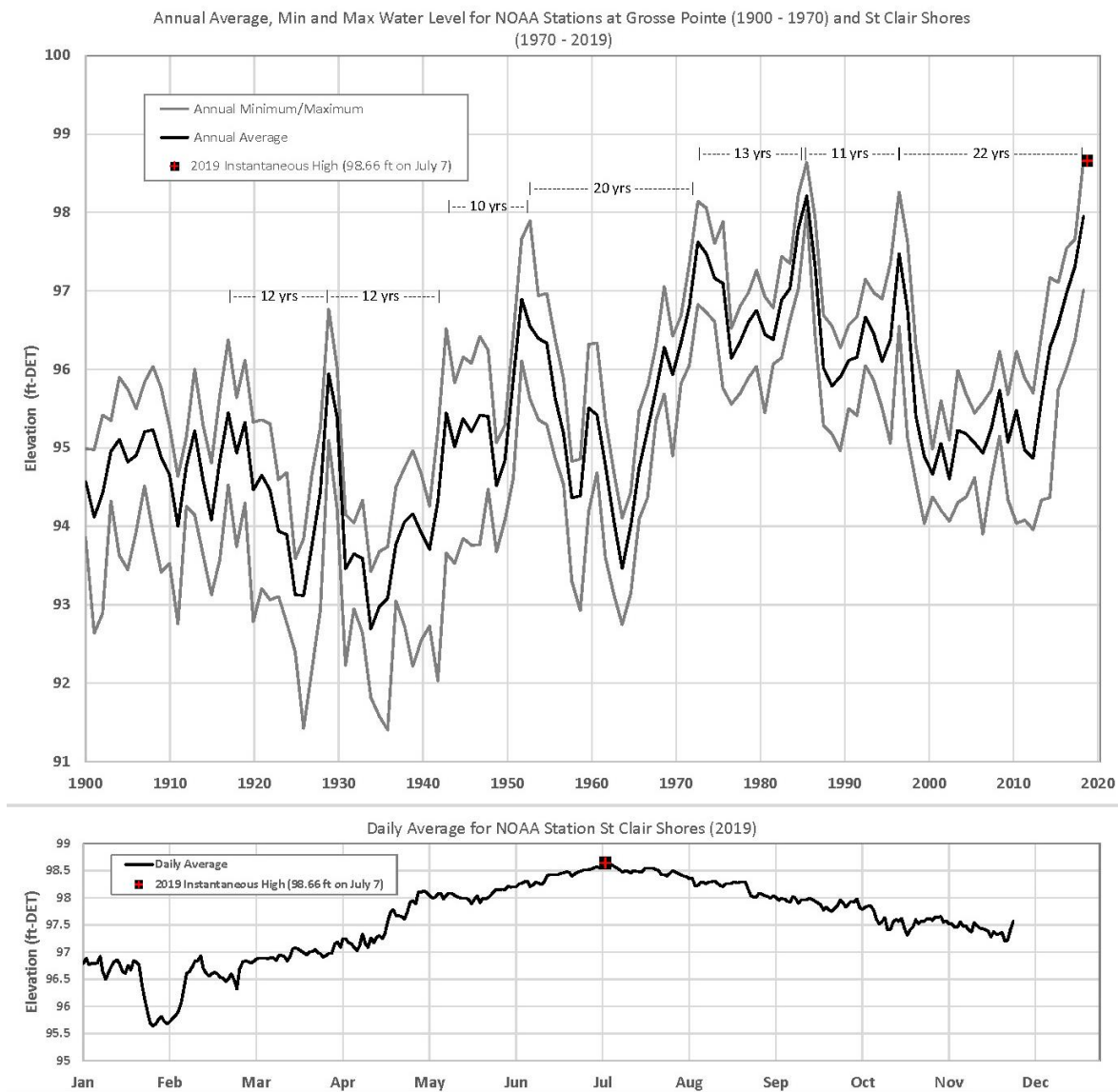

Figure 5-5. Lake St Clair Water Surface Elevation Cycles (1900 through 2019)

Table 5-3. Outfall Capacity based on River Elevation

		River Elev. (ft)				
		96.0	96.5	97.0	97.4	98.0
Flow (mgd)	DRO	742	706	650	600	501
	RRO	1,538	1,484	1,380	1,290	1,094
	WWTP	2,280	2,190	2,030	1,890	1,595

5.8.2 Climate Change Impacts in the Midwest and Great Lakes Region

The Fourth National Climate Assessment (NCA4) provides the latest synthesis of climate change impacts in the United States. The Great Lakes Integrated Sciences and Assessments (GLISA) also tracks climate change projections and adaptation opportunities in the region. Notable climate change impacts in the Midwest and/or Great Lakes Region include:

- Increased annual average temperatures, with record-setting hot years to be more common; these are expected to increase in magnitude depending on climate scenario further into late century. Temperatures have already increased 2.3°F since 1951 and are expected to increase between 3°F -6°F and 6°F -11°F by 2050 and 2100 respectively.
- Increased precipitation of up to 20% in the winter and spring in the Midwest by late century based on a 1986-2015 baseline ; Annual precipitation has increased by 14% since 1951 in the region.
- Increased frequency and intensity of heavy precipitation events. The observed change in Midwest precipitation events that exceeds the 99th percentile of daily values has increased between 39-42%, This includes an increase in frequency and intensity of severe thunderstorms in the Midwest, especially during the spring.
- Lake surface temperatures rose at a faster rate than air temperatures, which may result in reduced lake ice cover (though there is high variability). Along with increased evaporation, this may lead to more lake-effect precipitation, falling more as rain than snow.
- Lake levels, driven by precipitation, evaporation, and runoff, may vary and with increasing variability, meaning there could be periods of time with low or high lake levels.

5.8.3 Climate Change Implications for the GLWA's Wastewater Infrastructure

A key finding from the NCA4 is that these climate change impacts create additional risks or failure rates to already stressed infrastructure systems. The NCA4 recommends that infrastructure systems adapt to climate change to reduce the risk of failure and maintain their ability to provide essential services to populations. Climate change may result in the following impacts to the GLWA's wastewater infrastructure:

- Extreme precipitation events can overwhelm combined sewer systems which may result in more frequent discharge of untreated wastewater into the Detroit River and Rouge River, and/or more frequent discharge of primary effluent at the WRRF. Warmer river and lake water levels may amplify this issue contributing to lower dissolved oxygen concentrations and/or algal blooms.
- Extreme precipitation events may result in localized flooding and/or increases in water levels of the Detroit River. These may result in flooding of low lying GLWA assets – the consequences of which may range from minor asset damage to lengthy outages.
- GLWA's operations depend on reliable power from the electric grid. Both increased heat waves and extreme storm events may result in more frequent power outages in the region.

Global climate models predict rainfall intensity and frequency to increase with climate change in the Great Lakes region. Impact of these more frequent and intense events are being analyzed as a part of the collection system modeling and should be regularly re-evaluated to assess the impact on the WRRF. To account for these factors, the master planning effort has used historic high and low Detroit River levels in our analyses moving forward, however as additional information is obtained this assumption should be revisited.

5.8.4 Analysis of Climate Models and Potential Changes to Rainfall Frequency, Duration and Intensity

In 2019, SEMCOG and Michigan DOT conducted a Climate Resiliency and Flooding Mitigation Study as a basis for transportation planning in southeast Michigan. This study included an analysis of output from six climate models to develop intensity-duration-frequency (IDF) curves that reflect potential future changes in local climate for mid-century (year 2050) and end of century (year 2100). The climate models, analysis methods, and IDF development are discussed in the report titled Precipitation Intensity-Duration-Frequency under Future Climate, SEMCOG Region, Michigan, prepared by Tetra Tech, May 2019.

The projected IDF curves were analyzed for the Wastewater Master Plan to develop potential mid-century hyetographs for the 10-year 1-hour and 10-year 24-hour storms. Two analyses were done: one to establish the average change projection from the six climate models, and a second to establish the least change projection from the six models. To develop the hyetographs, a rainfall distribution (NRCS Midwest and Southeast US Type 3) was applied to the projected rainfall depths for the average change projection and the least change projection.

Figure 5-6 compares the 10-year 1-hour design storm for today's Atlas 14 hyetograph to potential mid-century average change and least change predictions. The average change projection yields a 10-year 1-hour storm depth of 3.03 inches, which is approximately today's 200-year 1-hour event based on Atlas 14. The least change projection yields a 10-year 1-hour event storm depth of 2.09 inches, which is approximately today's 25-year 1-hour event based on Atlas 14.

Figure 5-7 compares the 10-year 24-hour storm depth for today's Atlas 14 hyetograph to potential mid-century average change and least change predictions. The average change projection yields a 10-year 24-hour storm depth of 3.31 inches, which is approximately today's 25-year 1-hour event based on Atlas 14. The least change projection yields a 10-year 24-hour event storm depth is 3.31 inches, which is the same as the Atlas 14 depth for the 10-year 24-hour event.

Climate models and predictions need to be reassessed on a periodic basis. Section 9 proposes processes for assessing water quality improvements, rainfall trends, and Detroit River elevation cycles at 5-year intervals.

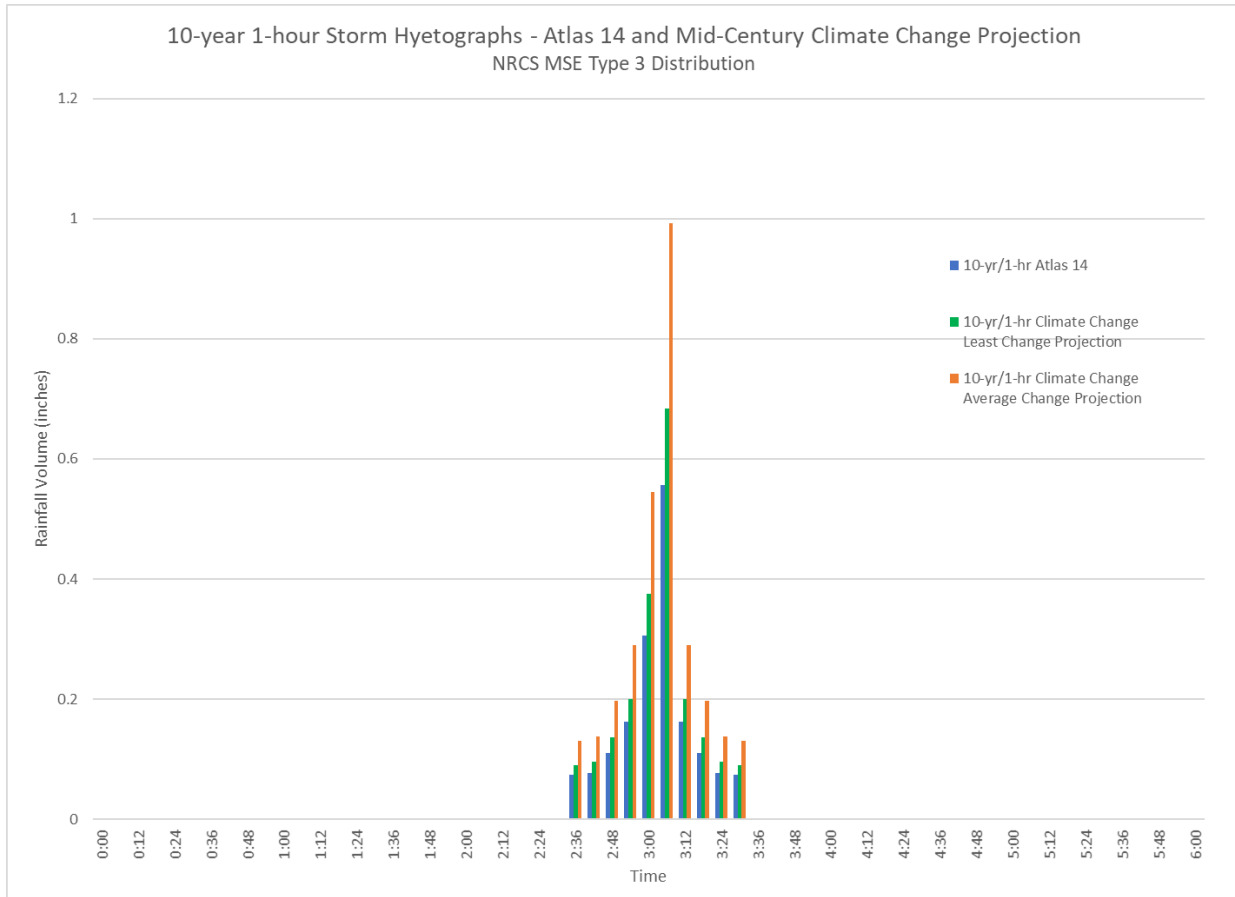

Figure 5-6. Comparison of the 10-year 1-hour Design Storm to Potential Mid-Century Average Change and Least Change Predictions

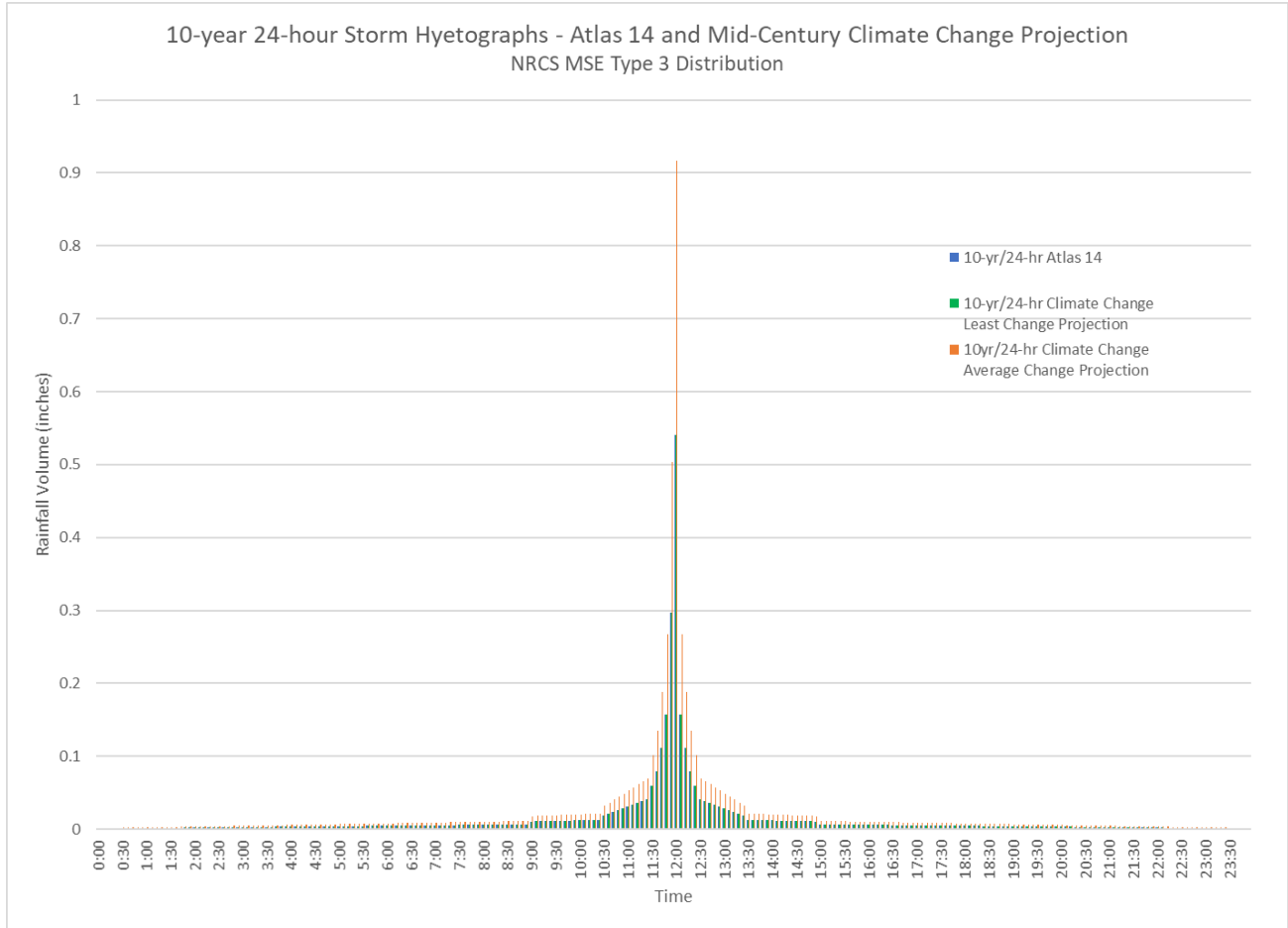

Figure 5-7. Comparison of the 10-year 24-hour Design Storm to Potential Mid-Century Average Change and Least Change Predictions

Section 6

Collection System

6.1 Overview

This section describes process used to identify and evaluate alternatives for collection system improvements and water quality protection from combined sewer overflows and sanitary sewer overflows. A wide range of solutions was identified based on previous studies and new investigations underway by GLWA and its Members. The wide range of solutions was narrowed to a shorter list based on screening criteria and an analysis of the root causes for overflows upstream of each CSO outfall in the City of Detroit. Following this screening process, selected alternatives were evaluated using the regional wastewater collection system model and river water quality models to compare the relative water quality benefits of the selected alternatives. In addition, the selected alternatives were compared in a decision support scoring framework based on the 5 outcomes identified in Section 2.

This section also describes the analysis of collection system capacity, condition assessment and long-term redundancy requirements. GLWA's leased trunk sewer, interceptors, and pump stations generally have capacity for a 10-year 24-hour design storm. Condition assessment and rehabilitation projects have been recently completed by GLWA on pump stations, condition assessments for CSO facilities is underway in project CS-299. Long term collection system redundancy requirements were analyzed based on the ability to convey dry weather flow during interceptor rehabilitation.

Cost estimates for alternatives are presented at a summary level in this section. Detailed cost estimates are presented in Technical Memorandum 7, Appendix A.

6.2 Identification of Alternatives for Wet Weather Water Quality Protection

As noted in Section 3, the GLWA and its Members in the regional service area have constructed substantial infrastructure and developed operational practices to control over 95 percent of wet weather flow on an annual basis. Many types of control technologies are well understood in the region, and a series of previous Long Term CSO Control Plans from 1996 to 2010 and engineering studies of sanitary sewer overflow controls have examined a range of solutions for remaining uncontrolled CSO and SSOs.

Table 6-1 presents terminology and categories of CSO control technologies. Wet weather regulatory compliance requires the use of a variety of infrastructure improvements and operational practices designed to address specific causes of overflow within the service area. Cost-effective compliance solutions typically include a combination of the following control technologies:

- Green Infrastructure and Inflow Source Control

- Operational Optimization
- Infrastructure Optimization
- Asset Management
- Grey Infrastructure

Table 6-1. Categories of Technology for Combined Sewer Overflow Control

<p>Non-Structural Regional Optimization & Coordination</p> <p style="text-align: center;">IWOP</p> <p style="text-align: center;">Real Time Control</p> <p style="text-align: center;">Weir and Regulator Modifications</p> <p style="text-align: center;">In-System Storage</p> <p style="text-align: center;">Contract Capacity Change</p> <p style="text-align: center;">CMOM (Inspections & Cleaning)</p> <p style="text-align: center;">IDEP</p> <p style="text-align: center;">Water Quality</p> <p style="text-align: center;">Monitoring</p>	<p style="text-align: center;">Regional Collection & Conveyance System</p>		
	<p style="text-align: center;">Green Infrastructure & Inflow Controls</p> <p style="text-align: center;">Green Infrastructure</p> <p style="text-align: center;">Sewer Separation</p> <p style="text-align: center;">Catch Basin Restrictors</p> <p style="text-align: center;">River Inflow Controls</p> <p style="text-align: center;">Downspout & Footing Drain Disconnection</p> <p style="text-align: center;">DCIA Reduction</p>	<p style="text-align: center;">Conveyance Rehab</p> <p style="text-align: center;">Pipeline Rehabilitation</p> <p style="text-align: center;">Manhole Rehabilitation</p> <p style="text-align: center;">Outfall Rehabilitation</p> <p style="text-align: center;">Pump Station Rehabilitation</p> <p style="text-align: center;">Regulator Rehabilitation</p>	<p style="text-align: center;">New Conveyance</p> <p style="text-align: center;">New Pipelines</p> <p style="text-align: center;">Major Pipeline Reconstruction</p> <p style="text-align: center;">Outfall Relocation</p>
	<p style="text-align: center;">Regional Treatment System</p>		
	<p style="text-align: center;">WRRF Upgrades & Rehabilitation</p> <p style="text-align: center;">Pumping</p> <p style="text-align: center;">Preliminary Treatment</p> <p style="text-align: center;">Secondary Treatment</p> <p style="text-align: center;">Disinfection</p> <p style="text-align: center;">Biosolids</p> <p style="text-align: center;">Plant Utilities</p>	<p style="text-align: center;">Remote Facility Expansion & Rehab</p> <p style="text-align: center;">RTB and SDF Service Area Expansion</p> <p style="text-align: center;">RTB & SDF Improvements</p>	<p style="text-align: center;">New Treatment Storage Facility</p> <p style="text-align: center;">New RTB and SDF</p> <p style="text-align: center;">In-Line Disinfection</p> <p style="text-align: center;">Netting</p> <p style="text-align: center;">Dechlorination</p>
	<p style="text-align: center;">Legend</p> <p style="text-align: center;"><i>Blue-Asset Management</i></p> <p style="text-align: center;"><i>Red-Optimization</i></p> <p style="text-align: center;"><i>Orange-Low Cost Controls</i></p> <p style="text-align: center;"><i>Green-GSI/Inflow Control</i></p> <p style="text-align: center;"><i>Grey -Grey Infrastructure</i></p>		

Based on the application of CSO control technologies and results of previous studies, the Wastewater Master Plan began its analysis of alternatives by identifying candidate solutions for specific locations.

Candidate solutions are capital projects or operation and maintenance activities within the categories above, and at specific locations, that are designed to reduce the impact of wet weather discharges. Each candidate solution has a performance impact, such as a reduction in untreated wet weather discharge volume, frequency of occurrence or reduction in wet weather discharge pollutant load. Candidate solutions can apply to stormwater discharges, sanitary sewer overflows, combined sewer overflows, and treatment facilities. Combinations of candidate solutions were identified by water body to create alternatives. These candidate solutions are listed in Tables 6-2 to 6-5 organized by water body.

Table 6-2. Preliminary Identification of Alternatives for the Clinton River and Lake St Clair*

Impacted Waterbody	Preliminary Alternative Name and Location	Original Idea for Preliminary Alternative	Type of Alternative	Discharges Controlled
Lake St. Clair	Expand Chapaton RTB	Macomb County	Retention Treatment Basin	Chapaton RTB
Lake St. Clair	Water Fowl Management	Macomb County	Regional Operating Plan	
Lake St. Clair	CMOM SEMSD	WWMP	CMOM BMP (Inspections & Cleaning)	Multiple Outfalls
Lake St. Clair	CMOM Grosse Pointe Farms	WWMP	CMOM BMP (Inspections & Cleaning)	Multiple Outfalls
Lake St. Clair	IDEP SEMSD	WWMP	IDEP	Separated Storm Drains
Lake St. Clair	IDEP Grosse Pointe Farms	WWMP	IDEP	Separated Storm Drains
Clinton River East Subwatershed	CMOM Centerline	WWMP	CMOM BMP (Inspections & Cleaning)	Multiple Outfalls
Clinton River East Subwatershed	IDEP Centerline	WWMP	IDEP	Separated Storm Drains
Clinton River Red Run Subwatershed	Habitat Restoration on Red Run Drain	WWMP	Green Infrastructure	
Clinton River Red Run Subwatershed	GWK District Green Infrastructure	WWMP	Green Infrastructure	B-23, B-07
Clinton River Red Run Subwatershed	Additional Treatment for GWK RTB	MCDPW	Retention Treatment Basin	GWK RTB
Clinton River Red Run Subwatershed	Peak Stream Flow Management	CRWA	Regional Operating Plan	
Clinton River Red Run Subwatershed	CMOM GWK	WWMP	CMOM BMP (Inspections & Cleaning)	Multiple Outfalls
Clinton River Red Run Subwatershed	IDEP GWK	WWMP	IDEP	Separated Storm Drains
Impacted Waterbody	Preliminary Alternative Name and Location	Original Idea for Preliminary Alternative	Type of Alternative	Discharges Controlled

*Red text indicates that these outfalls are designated as Priority Non-Core in the NPDES Permit

Table 6-3. Preliminary Identification of Alternatives for the Detroit River*

Impacted Waterbody	Preliminary Alternative Name and Location	Original Idea for Preliminary Alternative	Type of Alternative	Discharges Controlled
Detroit River Downtown	Near East Side Sewer Separation	WWMP	Sewer Separation	B-07, B-010

Impacted Waterbody	Preliminary Alternative Name and Location	Original Idea for Preliminary Alternative	Type of Alternative	Discharges Controlled
Detroit River Downtown	I-375 Sewer Separation	WWMP	Sewer Separation	B-18
Detroit River Downtown	Near East Side Sewer Separation	WWMP	Sewer Separation	B-08
Detroit River Downtown	I-94 Sewer Separation	WWMP	Sewer Separation	B-03 to B-020
Detroit River Downtown	OCWRC EFSD Footing Drain Disconnections	WWMP	Footing Drain Disconnection	B-23, B-07
Detroit River Downtown	Relocate Outfall B-25 for West Riverfront Park	WWMP	Outfall Relocation	B-25
Detroit River Downtown	Relocate Outfall B-26 for West Riverfront Park	WWMP	Outfall Relocation	B-26
Detroit River Downtown	Relocate Outfall B-27 for West Riverfront Park	WWMP	Outfall Relocation	B-27
Detroit River Downtown	Maintenance Connection of DRI to NIEA	DR-226/WWMP	New Pipelines	Multiple Outfalls
Detroit River Downtown	B-29 Pumping, Screening & Disinfection Facility (Phase 1)	WWMP	Retention Treatment Basin	Multiple Outfalls
Detroit River Downtown	B-29 Add High Rate Clarification to Facility (Phase 2)	WWMP	Retention Treatment Basin	Multiple Outfalls
Detroit River Downtown	Jos. Campau Netting Facility	Plan of Record	Netting Facility	B-10
Detroit River Downtown	Orleans Netting Facility	Plan of Record	Netting Facility	B-14 and B-15
Detroit River Downtown	Riopelle Netting Facility	Plan of Record	Netting Facility	B-16
Detroit River Downtown	Rivard Netting Facility	Plan of Record	Netting Facility	B-17
Detroit River Downtown	Hastings Netting Facility	Plan of Record	Netting Facility	B-18
Detroit River Downtown	Randolph Netting Facility	Plan of Record	Netting Facility	B-19
Detroit River Downtown	Bates Netting Facility	Plan of Record	Netting Facility	B-20
Detroit River Downtown	Woodward Netting Facility	Plan of Record	Netting Facility	B-21
Detroit River Downtown	1st Hamilton Netting Facility	Plan of Record	Netting Facility	B-23
Detroit River Downtown	3rd Street Netting Facility	Plan of Record	Netting Facility	B-24
Detroit River Downtown	Cabacier Netting Facility	Plan of Record	Netting Facility	B-25
Detroit River Downtown	11th Netting Facility	Plan of Record	Netting Facility	B-26
Detroit River Downtown	Vermont Netting Facility	Plan of Record	Netting Facility	B-28

Impacted Waterbody	Preliminary Alternative Name and Location	Original Idea for Preliminary Alternative	Type of Alternative	Discharges Controlled
Detroit River Downtown	Add Dechlorination at Leib SDF	WWMP	Screening & Disinfection Facility	105
Detroit River Downtown	Add Dechlorination at St Aubin SDF	WWMP	Screening & Disinfection Facility	106
Detroit River Downtown	18th Netting Facility	Plan of Record	Netting Facility	B-29
Detroit River Downtown	24th Netting Facility	Plan of Record	Netting Facility	B-31
Detroit River Downtown	Jos. Campau Disinfection Facility	Plan of Record	Inline Disinfection Facility	B-10
Detroit River Downtown	Rivard Disinfection Facility	Plan of Record	Inline Disinfection Facility	B-17
Detroit River Downtown	24th Street Disinfection Facility	Plan of Record	Inline Disinfection Facility	B-31
Detroit River Downtown	Construct New RTB Under I-375 Improvements	WWMP	Retention Treatment Basin	B-017
Detroit River Downtown	Brush Sewer -- Bates and Woodridge Streets 4.83 million gal	LTCISO Work Group 1996	In-System Storage	B-20
Detroit River Downtown	In-System Storage at NE Pump Station	Regional Operating Plan	In-System Storage	B-07
Detroit River Downtown	Remote Activation of VR-15 and VR-16	Quick Win	Interim Wet Weather Operating Plan	B-07
Detroit River Downtown	Fairview PS Diversion to Conner RTB	Regional Operating Plan	Interim Wet Weather Operating Plan	104
Detroit River Downtown	DRI Regulator Improvements	Quick Win	Interim Wet Weather Operating Plan	B-05 to B-28
Detroit River Downtown	CMOM Highland Park	WWMP	CMOM BMP (Inspections & Cleaning)	Multiple Outfalls
Detroit River Downtown	CMOM Hamtramack	WWMP	CMOM BMP (Inspections & Cleaning)	Multiple Outfalls
Detroit River Downtown	IDEP Highland Park	WWMP	IDEP	Separated Storm Drains
Detroit River Downtown	IDEP Hamtramack	WWMP	IDEP	Separated Storm Drains
Detroit River Downtown	Increase Capacity of WRRF by 500 CFS	WWMP	WRRF Pumping Improvements	Multiple Outfalls
Detroit River East	Meldrum District Connection to Lieb SDF	Plan of Record	RTB and SDF Service Area Expansion	B-07

Impacted Waterbody	Preliminary Alternative Name and Location	Original Idea for Preliminary Alternative	Type of Alternative	Discharges Controlled
Detroit River East	Dredge Conner Creek Channel to Restore Outlet Capacity	WWMP	RTB and SDF Service Area Expansion	104
Detroit River East	Grosse Pointe Farms Sewer Separation	WWMP	Sewer Separation	Conner RTB (104)
Detroit River East	Fischer District Sewer Separation	WWMP	Sewer Separation	B-03, B-05
Detroit River East	Old English Village Sewer Separation	WWMP	Sewer Separation	Conner RTB (104)
Detroit River East	Fischer District Sewer Separation	WWMP	Sewer Separation	B-04, B-06
Detroit River East	McClellan (Parkview) Netting Facility	Plan of Record	Netting Facility	B-03
Detroit River East	Fischer Netting Facility	Plan of Record	Netting Facility	B-04
Detroit River East	Iroquois Netting Facility	Plan of Record	Netting Facility	B-05
Detroit River East	Helen Netting Facility	Plan of Record	Netting Facility	B-06
Detroit River East	Adair Netting Facility	Plan of Record	Netting Facility	B-09
Detroit River East	Add Dechlorination at Conner Creek RTB	WWMP	Retention Treatment Basin	104
Detroit River East	Add Dechlorination at Belle Isle RTB		Retention Treatment Basin	
Detroit River East	Add 240 MGD High Rate Clarification at Conner RTB	Regional Operating Plan	Retention Treatment Basin	104
Detroit River East	Fischer Disinfection Facility	Plan of Record	Inline Disinfection Facility	B-04, B-03, B-05
Detroit River East	Helen Disinfection Facility	Plan of Record	Inline Disinfection Facility	B-06
Detroit River East	Conner 5.27 Million Gallons CC2A	CS-1329 June 2000	In-System Storage	Near East Side Outfalls
Detroit River East	Ashland Relief 3.14 Million Gallons AR1A	CS-1329 June 2000	In-System Storage	Near East Side Outfalls
Detroit River East	Ashland Relief 3.77 Million Gallons AR2	CS-1329 June 2000	In-System Storage	Near East Side Outfalls
Detroit River East	Ashland Relief 3.18 Million Gallons AR1	CS-1329 June 2000	In-System Storage	Near East Side Outfalls
Detroit River East	Ashland 2.67 Million Gallons ASHL1A	CS-1329 June 2000	In-System Storage	Near East Side Outfalls

Impacted Waterbody	Preliminary Alternative Name and Location	Original Idea for Preliminary Alternative	Type of Alternative	Discharges Controlled
Detroit River East	CMOM Grosse Pointe	WWMP	CMOM BMP (Inspections & Cleaning)	Multiple Outfalls
Detroit River East	CMOM Grosse Pointe Park	WWMP	CMOM BMP (Inspections & Cleaning)	Multiple Outfalls
Detroit River East	IDEP Grosse Pointe	WWMP	IDEP	Separated Storm Drains
Detroit River East	IDEP Grosse Pointe Park	WWMP	IDEP	Separated Storm Drains
Detroit River East	Macomb County Footing Drain Disconnections	WWMP	Footing Drain Disconnection	B-23, B-07
Detroit River West	Conner and Freud Pumping Station Improvements (CS-120)	GLWA CIP	Pump Station Rehabilitation	Conner RTB 104
Detroit River West	Rehabilitation of the Detroit River Interceptor (DB-226)	GLWA CIP	Pipeline Rehabilitation	Multiple Outfalls
Detroit River West	GHIB Area Sewer Separation	WWMP	Sewer Separation	B-37, B-38, B-42
Detroit River West	McKinstry Netting Facility	Plan of Record	Netting Facility	B-35
Detroit River West	Summit-Clark/Ferdinand Netting Facility	Plan of Record	Netting Facility	B-36 and B-37
Detroit River West	Morrel Netting Facility	Plan of Record	Netting Facility	B-38
Detroit River West	Schroeder Netting Facility	Plan of Record	Netting Facility	B-42
Detroit River West	Morrel In-System Storage Facility	Quick Win	In-System Storage	B-38
Detroit River West	Calvary In-System Storage Facility	Quick Win	In-System Storage	TBD
Detroit River West	Clark In-System Storage Facility	Quick Win	In-System Storage	B-36, B-37
Detroit River West	Upper Livernois Relief In-System Storage	Quick Win	In-System Storage	TBD
Detroit River West	GHIB Dewatering Control	WWMP	Regional Operating Plan	B-37, B-38, B-42

*Red text indicates Priority Non-Core in the NPDES Permit

Table 6-4. Preliminary Identification of Alternatives for the Rouge River*

Impacted Waterbody	Preliminary Alternative Name and Location	Original Idea for Preliminary Alternative	Type of Alternative	Discharges Controlled
Ashcroft-Sherwood Drain	Redford Township Sewer Separation	WWMP	Sewer Separation	U3, U4, U5, U9, U10, U11
Ashcroft-Sherwood Drain	Redford Township Green Infrastructure	WWMP	Green Infrastructure	U3, U4, U5, U9, U10, U11
Ashcroft-Sherwood Drain	Redford Township Expand Service Area of RTB	WWMP	Retention Treatment Basin	45A, U2, U1
Ashcroft-Sherwood Drain	Redford Township New RTB	WWMP	Retention Treatment Basin	45A, U2, U1
Lower Rouge River	Inkster Sewer Separation	WWMP	Sewer Separation	10, 11, L41, L42
Lower Rouge River	Inkster Green Infrastructure	WWMP	Green Infrastructure	10, 11, L41, L42
Lower Rouge River	Inkster Expand Service Area of Middlebelt RTB	WWMP	Retention Treatment Basin	10, 11, L41, L42
Main Rouge River Between Upper and Lower Rouge Rivers	West Warren Siphon Improvements	Quick Win	Pipeline Rehabilitation	B-054
Main Rouge River Between Upper and Lower Rouge Rivers	Warren Siphon District Sewer Separation	WWMP	Sewer Separation	B-054
Main Rouge River Between Upper and Lower Rouge Rivers	West Chicago and Plymouth Sewer Separation	WWMP	Sewer Separation	B-063, B-064
Main Rouge River Between Upper and Lower Rouge Rivers	Additional Sewer Separation West of New NWI South of I-96	WWMP	Sewer Separation	Multiple Outfalls
Main Rouge River Between Upper and Lower Rouge Rivers	Green Infrastructure for Warren Siphon	DWSD GSI Program	Green Infrastructure	B-054
Main Rouge River Between Upper and Lower Rouge Rivers	Remove River Inflow -- West Chicago West of River	Quick Win	River Inflow Control	B-063
Main Rouge River Between Upper and Lower Rouge Rivers	Remove River Inflow -- Plymouth	Quick Win	River Inflow Control	B-064
Main Rouge River Between Upper and Lower Rouge Rivers	Remove River Inflow -- West Chicago East of River	Quick Win	River Inflow Control	B-060, B-061, B-062

Impacted Waterbody	Preliminary Alternative Name and Location	Original Idea for Preliminary Alternative	Type of Alternative	Discharges Controlled
Main Rouge River Between Upper and Lower Rouge Rivers	Backwater Gate at B-063	Quick Win	River Inflow Control	B-063
Main Rouge River Between Upper and Lower Rouge Rivers	Lyndon Bramell First Flush Basin & Associated Influent Sewers	Plan of Record	Retention Treatment Basin	B-070, B-071
Main Rouge River Between Upper and Lower Rouge Rivers	Lahser Dolson First Flush Basin & Associated Influent Sewers	Plan of Record	Retention Treatment Basin	B-067, B-068
Main Rouge River Between Upper and Lower Rouge Rivers	W. Chicago First Flush Basin & Associated Influent Sewers	Plan of Record	Retention Treatment Basin	B-060, B061, B-062
Main Rouge River Between Upper and Lower Rouge Rivers	Trinity Tireman First Flush Basin & Associated Influent Sewers	Plan of Record	Retention Treatment Basin	B-056, B-057, B-058
Main Rouge River Between Upper and Lower Rouge Rivers	Schoolcraft / West Parkway Netting Facility	Plan of Record	Netting Facility	B-069
Main Rouge River Between Upper and Lower Rouge Rivers	Lahser Dolson Netting Facility	Plan of Record	Netting Facility	B-067, B-068
Main Rouge River Between Upper and Lower Rouge Rivers	Glendale Netting Facility	Plan of Record	Netting Facility	B-065
Main Rouge River Between Upper and Lower Rouge Rivers	W. Chicago Siphon Netting Facility	Plan of Record	Netting Facility	B-060, B061, B-062
Main Rouge River Between Upper and Lower Rouge Rivers	W. Chicago Netting Facility	Plan of Record	Netting Facility	B-060, B061, B-062
Main Rouge River Between Upper and Lower Rouge Rivers	Trinity Tireman Netting Facility	Plan of Record	Netting Facility	B-056, B-057, B-058
Main Rouge River Between Upper and Lower Rouge Rivers	Warren Netting Facility	Plan of Record	Netting Facility	B-054

Impacted Waterbody	Preliminary Alternative Name and Location	Original Idea for Preliminary Alternative	Type of Alternative	Discharges Controlled
Main Rouge River Between Upper and Lower Rouge Rivers	Pulaski Netting Facility	Plan of Record	Netting Facility	048 (No B-#)
Main Rouge River Between Upper and Lower Rouge Rivers	Schoolcraft / West Parkway Disinfection Facility	Plan of Record	Inline Disinfection Facility	B-069
Main Rouge River Between Upper and Lower Rouge Rivers	Lahser Dolson Disinfection Facility	Plan of Record	Inline Disinfection Facility	B-067, B-068
Main Rouge River Between Upper and Lower Rouge Rivers	Glendale Disinfection Facility	Plan of Record	Inline Disinfection Facility	B-065
Main Rouge River Between Upper and Lower Rouge Rivers	W. Chicago Siphon Disinfection Facility	Plan of Record	Inline Disinfection Facility	B-060, B061, B-062
Main Rouge River Between Upper and Lower Rouge Rivers	W. Chicago Disinfection Facility	Plan of Record	Inline Disinfection Facility	B-060, B061, B-062
Main Rouge River Between Upper and Lower Rouge Rivers	Trinity Tireman Disinfection Facility	Plan of Record	Inline Disinfection Facility	B-056, B-057, B-058
Main Rouge River Between Upper and Lower Rouge Rivers	Warren Disinfection Facility	Plan of Record	Inline Disinfection Facility	B-054
Main Rouge River Between Upper and Lower Rouge Rivers	Optimize VR-9	IWOP/Quick Win	Interim Wet Weather Operating Plan	Multiple Outfalls
Main Rouge River Between Upper and Lower Rouge Rivers	Rehabilitate In System Storage Tributary to Rouge River	Quick Win	In-System Storage	Multiple Outfalls
Main Rouge River Downstream of Lower Rouge River	NWI Diversion to Oakwood RTB	DWSD 2014	RTB and SDF Service Area Expansion	SSO Dearborn & RVSD
Main Rouge River Downstream of Lower Rouge River	Dearborn CSO 01, 03, 04 Sewer Separation	Dearborn CSO Rvsd BOD	Sewer Separation	01, 03, 04

Impacted Waterbody	Preliminary Alternative Name and Location	Original Idea for Preliminary Alternative	Type of Alternative	Discharges Controlled
Main Rouge River Downstream of Lower Rouge River	Dearborn CS013-014 First Flush Basin and SDF	Dearborn CSO Rvsd BOD	Retention Treatment Basin	013, 014
Main Rouge River Downstream of Lower Rouge River	Add Dechlorination at Baby Creek	WWMP	Retention Treatment Basin	
Main Rouge River Downstream of Lower Rouge River	Add Dechlorination at Oakwood	WWMP	Retention Treatment Basin	
Main Rouge River Downstream of Lower Rouge River	Add Dechlorination at Hubbell-Southfield	WWMP	Retention Treatment Basin	
Main Rouge River Downstream of Lower Rouge River	Wyoming In-System Storage Facility	Quick Win	In-System Storage	TBD
Main Rouge River Downstream of Lower Rouge River	Optimize VR-8	IWOP/Quick Win	Interim Wet Weather Operating Plan	101
Main Rouge River Downstream of Lower Rouge River	CMOM RVSDS	WWMP	CMOM BMP (Inspections & Cleaning)	Multiple Outfalls
Main Rouge River Downstream of Lower Rouge River	CMOM Dearborn	WWMP	CMOM BMP (Inspections & Cleaning)	Multiple Outfalls
Main Rouge River Downstream of Lower Rouge River	CMOM Melvindale	WWMP	CMOM BMP (Inspections & Cleaning)	Multiple Outfalls
Main Rouge River Downstream of Lower Rouge River	CMOM Allen Park	WWMP	CMOM BMP (Inspections & Cleaning)	Multiple Outfalls
Main Rouge River Downstream of Lower Rouge River	IDEP RVSDS	WWMP	IDEP	Separated Storm Drains
Main Rouge River Downstream of Lower Rouge River	IDEP Dearborn	WWMP	IDEP	Separated Storm Drains

Impacted Waterbody	Preliminary Alternative Name and Location	Original Idea for Preliminary Alternative	Type of Alternative	Discharges Controlled
Main Rouge River Downstream of Lower Rouge River	IDEP Melvindale	WWMP	IDEP	Separated Storm Drains
Main Rouge River Downstream of Lower Rouge River	IDEP Allen Park	WWMP	IDEP	Separated Storm Drains
Main Rouge River Downstream of Lower Rouge River	North Interceptor West Arm		New Pipelines	
Main Rouge River Upstream of Upper Rouge River	OCWRC 57 CFS to POR 6 Mile Basin	WWMP	RTB and SDF Service Area Expansion	EFSDS SSO
Main Rouge River Upstream of Upper Rouge River	Additional Sewer Separation West of New NWI North of I-96	WWMP	Sewer Separation	Multiple Outfalls
Main Rouge River Upstream of Upper Rouge River	Florence and Ridge District Sewer Separation	WWMP	Sewer Separation	B-079
Main Rouge River Upstream of Upper Rouge River	Schoolcraft Siphon/Ray/Brammel District Sewer Separation	WWMP	Sewer Separation	B-069/B-070
Main Rouge River Upstream of Upper Rouge River	Glenhurst Siphon District Sewer Separation	WWMP	Sewer Separation	B-082
Main Rouge River Upstream of Upper Rouge River	27 Million Gallons of GSI with Weir Modification	WWMP	Green Infrastructure	B-54 to B-87
Main Rouge River Upstream of Upper Rouge River	OCWRC 57 CFS to Optimized Southfield Sewer	WWMP	Sewer Separation	EFSDS SSO
Main Rouge River Upstream of Upper Rouge River	Remove River Inflow -- Lyndon	Quick Win	River Inflow Control	B-072
Main Rouge River Upstream of Upper Rouge River	Remove River Inflow -- Glenhurst	Quick Win	River Inflow Control	B-082
Main Rouge River Upstream of Upper Rouge River	OCWRC 57 CFS to New NWI	WWMP	New Pipelines	EFSDS SSO
Main Rouge River Upstream of Upper Rouge River	Six Mile First Flush Basin and Collector Sewers (McNichols)	Plan of Record	Retention Treatment Basin	B-080, B-081
Main Rouge River Upstream of Upper Rouge River	Puritan Riverdale First Flush Basin and Collector Sewers	Plan of Record	Retention Treatment Basin	B-077

Impacted Waterbody	Preliminary Alternative Name and Location	Original Idea for Preliminary Alternative	Type of Alternative	Discharges Controlled
Main Rouge River Upstream of Upper Rouge River	Glendale First Flush Basin & Associated Influent Sewers	Plan of Record	Retention Treatment Basin	B-065
Main Rouge River Upstream of Upper Rouge River	Six Mile Netting Facility (McNichols)	Plan of Record	Netting Facility	B-080, B-081
Main Rouge River Upstream of Upper Rouge River	Puritan Riverdale Netting Facility	Plan of Record	Netting Facility	B-077
Main Rouge River Upstream of Upper Rouge River	Lyndon Bramell Netting Facility	Plan of Record	Netting Facility	B-070, B-071
Main Rouge River Upstream of Upper Rouge River	Six Mile Disinfection Facility (McNichols)	Plan of Record	Inline Disinfection Facility	B-080, B-081
Main Rouge River Upstream of Upper Rouge River	Puritan Riverdale Disinfection Facility	Plan of Record	Inline Disinfection Facility	B-077
Main Rouge River Upstream of Upper Rouge River	Lyndon Bramell Disinfection Facility	Plan of Record	Inline Disinfection Facility	B-070, B-071
Main Rouge River Upstream of Upper Rouge River	Expand Puritan Fenkell RTB to Serve Area East of River	WWMP	Retention Treatment Basin	102
Main Rouge River Upstream of Upper Rouge River	Expand Puritan Fenkell RTB to Serve Part of Redford Township	WWMP	Retention Treatment Basin	102
Main Rouge River Upstream of Upper Rouge River	Expand Seven Mile RTB to Serve Area East of River	WWMP	Retention Treatment Basin	103
Main Rouge River Upstream of Upper Rouge River	Add High Rate Clarification to OCWRC 57 CFS Alternatives	WWMP	Retention Treatment Basin	EFSDS SSO
Main Rouge River Upstream of Upper Rouge River	OCWRC Sanitary Retention Basins	OWRC LTCAP	Sanitary Retention Basin	EFSDS SSO
Main Rouge River Upstream of Upper Rouge River	Add Dechlorination at Seven Mile	WWMP	Retention Treatment Basin	103
Main Rouge River Upstream of Upper Rouge River	Add Dechlorination at Puritan Fenkell	WWMP	Retention Treatment Basin	102
Main Rouge River Upstream of Upper Rouge River	Weir Modifications at 6-Mile and Hubbell	WWMP	Weir and Regulator Modifications	B-080/B-081
Main Rouge River Upstream of Upper Rouge River	Automate Shiawassee Gate	Quick Win	Interim Wet Weather Operating Plan	102,103
Main Rouge River Upstream of Upper Rouge River	Improve Operational Control at PF and 7-Mile RTBs	Quick Win	Interim Wet Weather Operating Plan	102, 103

Impacted Waterbody	Preliminary Alternative Name and Location	Original Idea for Preliminary Alternative	Type of Alternative	Discharges Controlled
Main Rouge River Upstream of Upper Rouge River	CMOM EFSDS	WWMP	CMOM BMP (Inspections & Cleaning)	Multiple Outfalls
Main Rouge River Upstream of Upper Rouge River	CMOM Farmington	WWMP	CMOM BMP (Inspections & Cleaning)	Multiple Outfalls
Main Rouge River Upstream of Upper Rouge River	IDEP EFSDS	WWMP	IDEP	Separated Storm Drains
Main Rouge River Upstream of Upper Rouge River	IDEP Farmington	WWMP	IDEP	Separated Storm Drains
Middle Rouge River	Dearborn Heights Sewer Separation	WWMP	Sewer Separation	L-43, M-13, M-14
Middle Rouge River	Dearborn Heights Green Infrastructure	WWMP	Green Infrastructure	L-43, M-13, M-14

*Red text indicates Priority Non-Core in the NPDES Permit

Table 6-5. Preliminary Identification of Alternatives for Multiple Water Bodies*

Impacted Waterbody	Preliminary Alternative Name and Location	Original Idea for Preliminary Alternative	Type of Alternative	Discharges Controlled
Multiple/All	Wayne County LTCAP Phase 1	RVSD LTCAP	Pipeline Rehabilitation	RVSD SSO
Multiple/All	Rehabilitate NWI	WWMP	Pipeline Rehabilitation	Multiple Outfalls
Multiple/All	Rehabilitate Trunk Sewers: Eliminate PACP Scores 4 and 5	WWMP	Pipeline Rehabilitation	Multiple Outfalls
Multiple/All	2020 to 2030	WWMP	Pipeline Rehabilitation	Multiple Outfalls
Multiple/All	2031 to 2040	WWMP	Pipeline Rehabilitation	Multiple Outfalls
Multiple/All	2041 to 2050	WWMP	Pipeline Rehabilitation	Multiple Outfalls
Multiple/All	2051 to 2060	WWMP	Pipeline Rehabilitation	Multiple Outfalls
Multiple/All	Rehabilitate Interceptors: Eliminate PACP Scores 4 and 5	WWMP	Pipeline Rehabilitation	Multiple Outfalls
Multiple/All	2020 to 2030	WWMP	Pipeline Rehabilitation	Multiple Outfalls
Multiple/All	2031 to 2040	WWMP	Pipeline Rehabilitation	Multiple Outfalls
Multiple/All	2041 to 2050	WWMP	Pipeline Rehabilitation	Multiple Outfalls
Multiple/All	2051 to 2060	WWMP	Pipeline Rehabilitation	Multiple Outfalls
Multiple/All	Downspout Disconnection	NPDES Permit	DCIA Reduction	Multiple Outfalls
Multiple/All	Private Property GSI in Detroit	DWSD Storm Credit	Green Infrastructure	Multiple Outfalls
Multiple/All	Downspout Disconnections in Detroit	NPDES Permit	DCIA Reduction	Multiple Outfalls
Multiple/All	Catch Basin Restrictors in Detroit Tributary to Detroit River	WWMP	Catch Basin Restrictors	Multiple Outfalls
Multiple/All	Downspout Disconnection Tributary to Rouge River	NPDES Permit	DCIA Reduction	Multiple Outfalls
Multiple/All	MDOT Stormwater Removal from Southfield Sewer	WWMP	Green Infrastructure	Multiple Outfalls
Multiple/All	DWSD Stormwater Removal from Southfield Sewer	WWMP	Green Infrastructure	Multiple Outfalls
Multiple/All	Rouger River Log Jam Management	GLWA CIP	River Inflow Control	Multiple Outfalls
Multiple/All	River Inflow Management Program	WWMP	River Inflow Control	Multiple Outfalls
Multiple/All	Phase 2 CSO Control Conduit 8 mile to Warren	WWMP	New Pipelines	Multiple Outfalls

Impacted Waterbody	Preliminary Alternative Name and Location	Original Idea for Preliminary Alternative	Type of Alternative	Discharges Controlled
Multiple/All	Sanitary Floatables Skimmer Watercraft	WWMP	Netting Facility	Multiple Outfalls
Multiple/All	Wayne County LTCAP Phase 2 -- SRB in Livonia	RVSD LTCAP	Sanitary Retention Basin	RVSD SSO
Multiple/All	Dynamic Real Time Control	R&I	Real Time Control	Multiple Outfalls
Multiple/All	Clean Regulators to Increase Flow to Interceptor	Quick Win	CMOM BMP (Inspections & Cleaning)	Multiple Outfalls
Multiple/All	Update Head Discharge Curves for Detroit River Outfalls	Quick Win	Interim Wet Weather Operating Plan	Multiple Outfalls
Multiple/All	Reduce Pre-Storm Wet Well Level in PS1 and PS2 to EI 73	Quick Win	Interim Wet Weather Operating Plan	Multiple Outfalls
Multiple/All	Establish HGL and Reconcile Contract Capacity for RVSD	RVSD LTCAP	Interim Wet Weather Operating Plan	RVSD SSO
Multiple/All	Regional Water Quality Monitoring Program Phase 1	WWMP	Regional Operating Plan	Multiple Outfalls
Multiple/All	Regional Water Quality Monitoring Program Phase 2	WWMP	Regional Operating Plan	Multiple Outfalls
Multiple/All	Improvements for Climate Resilience	WWMP	Regional Operating Plan	Multiple Outfalls
Multiple/All	Rehabilitate In System Storage Tributary to Detroit River	Quick Win	In-System Storage	Multiple Outfalls
Multiple/All	CMOM DWSD Rouge River	WWMP	CMOM BMP (Inspections & Cleaning)	Multiple Outfalls
Multiple/All	CMOM DWSD Detroit River	WWMP	CMOM BMP (Inspections & Cleaning)	Multiple Outfalls
Multiple/All	CMOM OMIDD	WWMP	CMOM BMP (Inspections & Cleaning)	Multiple Outfalls
Multiple/All	IDEP DWSD Rouge River	WWMP	IDEP	Separated Storm Drains
Multiple/All	IDEP DWSD Detroit River	WWMP	IDEP	Separated Storm Drains
Multiple/All	IDEP OMIDD	WWMP	IDEP	Separated Storm Drains
Multiple/All	New Detroit River Interceptor	WWMP	New Pipelines	B-03 to B-045
Multiple/All	Regional Sewer Separation		Sewer Separation	Multiple Outfalls

*Red text indicates Priority Non-Core in the NPDES Permit

6.3 Root Cause Analysis

A root cause analysis was performed to analyze the hydraulic and hydrologic features of the combined sewer service areas in the GLWA and DWSD collection systems. Previous studies were reviewed along with early results of collection system modeling to identify the root causes of combined sewer discharges. In all cases, combined sewer overflows occur when the dry weather flow and wet weather flow exceeds interceptor conveyance capacity. However, each trunk sewer, tributary area, and interceptor connection point has unique characteristics that result in a variety of types of root causes. The results are presented in Table 6-6.

Table 6-6 Root Cause Analysis of Tributary Area Characteristics and Conveyance Capacity that Cause Combined Sewer Overflows.

Table 6-6. GLWA/DWSD Outfall Root Cause Analysis

GLWA Outfall	Location	Existing Regulatory Status	Potential CSO Control Solutions	Root Cause
B-001	Fox Creek	Prohibited	Continue to monitor, take corrective action as necessary	Emergency Overflow. Only intended to discharge in extreme events
B-003	McClellan Cadillac	Priority	Regulator improvements, sewer separation by converting existing relief sewers to separated storm drains, screening or netting and disinfection	Large trunk sewers and relief trunk sewers designed for 10-year storm and intended to overflow when regulator capacity to DRI is exceeded. Stormwater from I-94 is discharged through outfalls B-003, B-004 and B-006.
B-004	Fischer	Remaining		
B-005	Iroquois	Priority		
B-006	Helen	Remaining		
B-007	Meldrum	Priority	Meldrum Sewer diversion to Leib SDF	Discharges when capacity of NIEA is exceeded and when storm flows in tributary area south of NIEA exceed regulator capacity to the DRI is exceeded.
B-009	Adair	Remaining	Regulator improvements to maximize flow routing to WRRF, sewer separation by converting existing relief sewers to separate storm drains, screening or netting and disinfection	Large trunk sewers and relief trunk sewers designed for 10-year storm and intended to overflow when regulator capacity to DRI is exceeded.
B-010	Joseph Campau	Priority		
B-014	Orleans	Remaining		
B-015	Orleans Relief	Remaining		
B-016	Riopelle	Remaining		
B-017	Rivard	Remaining		
B-018	Hastings	Remaining		
B-019	Randolph	Remaining		
B-020	Bates/Brush	Priority		
B-021	Woodward	Remaining		
B-022	Griswold	Minimal		
B-023	First Street	Priority	Screening or netting and disinfection.	Discharges when capacity of NIEA is exceeded and when storm flows in tributary area south of NIEA exceed regulator capacity to the DRI is exceeded.
B-024	Third Street	Remaining	Netting and disinfection and/or relocate for construction of Ralph C Wilson Jr Park	Medium diameter trunk sewers intended to overflow when regulator capacity to DRI is exceeded.
B-025	Sixth Street	Remaining		

GLWA Outfall	Location	Existing Regulatory Status	Potential CSO Control Solutions	Root Cause
B-026	Eleventh Street	Remaining		
B-027	Rosa Parks Boulevard	Extreme	Relocate for construction of Ralph C Wilson Jr Park	Emergency Overflow. Only intended to discharge in extreme events
B-028	Sixteenth Street	Extreme	Pilot for Netting Facility of Relocated Outfalls	
B-029	Eighteenth Street	Priority	Regulator improvements, sewer separation, screening or netting and disinfection	Medium diameter trunk sewer intended to overflow when regulator capacity to DRI is exceeded.
B-030		Minimal	Continue to monitor, take corrective action as necessary	Changes in tributary area land use and drainage area now produce minimal volume during larger storm events.
B-031	Twenty-Fourth Street	Remaining	Regulator improvements, sewer separation, screening or netting and disinfection	Medium diameter trunk sewer intended to overflow when regulator capacity to DRI is exceeded
B-032		Minimal	Continue to monitor, take corrective action as necessary	Changes in tributary area land use and drainage area now produce minimal volume during larger storm events.
B-033		Minimal		
B-034		Minimal		
B-035		Extreme		Emergency Overflow. Only intended to discharge in extreme events.
B-036	Summit-Clark	Priority	Regulator improvements, sewer separation, screening or netting and disinfection	Medium diameter trunk sewer intended to overflow when regulator capacity to DRI is exceeded.
B-037	Ferdinand	Remaining		
B-038	Morrell	Remaining		
B-039		Minimal	Continue to monitor, take corrective action as necessary	Changes in tributary area land use and drainage area now produce minimal volume during larger storm events.
B-040	Campbell	Extreme	Continue to monitor, take corrective action as necessary	Emergency Overflow. Only intended to discharge in extreme events.
B-041	Livernois	Minimal	Continue to monitor, take corrective action as necessary	Changes in tributary area land use and drainage area now produce minimal volume during larger storm events.
B-042	Schroeder	Remaining	Regulator improvements, sewer separation, screening or netting and disinfection	Medium diameter trunk sewers intended to overflow when regulator capacity to DRI is exceeded.
B-044	Cary	Remaining		

GLWA Outfall	Location	Existing Regulatory Status	Potential CSO Control Solutions	Root Cause
B-045	Dearborn Street, Old Rouge	Minimal	Continue to monitor, take corrective action as necessary	Changes in tributary area land use and drainage area now produce minimal volume during larger storm events.
B-059	Pulaski Street, Old Rouge	Extreme	Continue to monitor, take corrective action as necessary	Emergency Overflow. Only intended to discharge in extreme events.
B-046	Carbon Street	Prohibited	Continue to monitor, take corrective action as necessary	Emergency Overflow. Only intended to discharge in extreme events
B-049	South Fort Street	Prohibited	Continue to monitor, take corrective action as necessary	Emergency Overflow. Only intended to discharge in extreme events.
B-050	South Fort Street	Prohibited	Continue to monitor, take corrective action as necessary	Emergency Overflow. Only intended to discharge in extreme events
B-054	Warren	Priority	Sewer separation with green infrastructure or first flush capture, screening or netting, and disinfection.	Frequent discharges with small volumes of overflow caused by downstream siphon size restriction or clogging
B-056, 057, 058	Tireman Avenue	Remaining	In-system storage or first flush capture basin with netting or screening and disinfection. New facility sizes could be reduced with green stormwater infrastructure.	Frequent overflows and high overflow volumes due to downstream capacity restrictions in the NWI and Hubbell and Southfield sewers.
B-060, 061, 062	West Chicago (East Shore)	Priority	In-system storage or first flush capture basin with netting or screening and disinfection. New facility sizes could be reduced with green stormwater infrastructure.	Frequent overflows and high overflow volumes due to downstream capacity restrictions in the NWI and Hubbell and Southfield sewers.
B-063	West Chicago (West Shore)	Remaining	Sewer separation with green infrastructure or first flush capture, screening or netting, and disinfection.	Frequent discharges with small volumes of overflow caused by downstream siphon size restriction or clogging
B-064	Plymouth	Remaining	Sewer separation with green infrastructure or first flush capture, screening or netting, and disinfection.	Frequent discharges with small volumes of overflow caused by downstream siphon size restriction or clogging
B-065	Glendale Relief	Priority	In-system storage or first flush capture basin with netting or screening and disinfection. New facility sizes could be reduced with green stormwater infrastructure.	Frequent overflows and high overflow volumes due to Hubbell and Southfield sewer capacity or weir heights
B-067. 068	Lahser (Dolson)	Priority	Relief sewer, in-system storage or first flush capture basin with netting or screening and disinfection. New facility sizes could be reduced with green stormwater infrastructure.	Infrequent overflows due to capacity downstream in NWI, and in-system storage for most storms.
B-069	West Parkway	Remaining	Sewer separation with green infrastructure or first flush capture, screening or netting, and disinfection.	Frequent discharges with small volumes of overflow caused by downstream siphon size restriction or clogging
B-070	Schoolcraft	Remaining	Sewer separation with green infrastructure or first flush capture, screening or netting, and disinfection.	Frequent discharges with small volumes of overflow caused by downstream siphon size restriction or clogging

GLWA Outfall	Location	Existing Regulatory Status	Potential CSO Control Solutions	Root Cause
B-071	Brammell	Remaining	Relief sewer, in-system storage, or first flush capture basin with netting or screening and disinfection. New facility sizes could be reduced with green stormwater infrastructure.	Infrequent overflows due to capacity in the NWI, and in-system storage for most storms.
B-072	Lyndon	Remaining	Sewer separation or first flush basin with netting and disinfection.	Infrequent overflows due to capacity downstream NWI and in-system storage for most storms.
B-075	Fenkell (East Shore)	Remaining	Sewer separation or first flush basin with netting and disinfection.	Medium diameter trunk sewer with limited volume for in-system storage.
B-077	Puritan (East Shore)	Remaining	Relief sewer and/or sewer separation projects	Sufficient NWI downstream capacity for most storms, in-system storage and small service areas
B-079	Florence and Ridge	Minimal	Continue to monitor, take corrective action as necessary	Infrequent overflows due to downstream NWI capacity and in-system storage for most storms.
B-080, 081	McNichols	Priority	In-system storage or first flush capture basin with netting or screening and disinfection. New facility sizes could be reduced with green stormwater infrastructure.	Frequent overflows and high overflow volumes due to downstream capacity restrictions in the NWI and Hubbell and Southfield sewers.
B-082	Glenhurst	Remaining	Relief sewer and/or sewer separation projects	Infrequent overflow due to capacity in NWI for small storms, in-system storage and small service area.
B-085	Seven Mile (East Shore)	Remaining	In-system storage or first flush capture basin with netting or screening and disinfection. New facility sizes could be reduced with green stormwater infrastructure.	Frequent overflows and high overflow volumes due to downstream NWI capacity restrictions.
B-087	Pembroke	Remaining	In-system storage or first flush capture basin with netting or screening and disinfection. New facility sizes could be reduced with green stormwater infrastructure.	Frequent overflows and high overflow volumes due to downstream NWI capacity restrictions.

6.4 Screening of Candidate Solutions

The list of candidate solutions was reviewed with the Steering Team, Technical Interest Groups, and the Regional Collaboration Group over a series of meetings in 2018 and 2019. Screening was performed to select the most promising candidate solutions for simulation by modeling with the RWCS model and the receiving water models.

Screening criteria were identified and evaluated based on the factors presented in Table 6-7. In the table below, the term “candidate solution” refers to a project that would create an operational change or a physical infrastructure change to the collection system.

In some locations, particularly for the GLWA Members Redford Township, Dearborn Heights and Inkster, there are multiple candidate solutions, but only one was selected for regional modeling. Using the example of the Redford Township central sewer district which is tributary to the Bell Branch of the Rouge River. This sewer district has five feasible solutions:

1. Sewer Separation
2. Outfall consolidation and routing of overflow to a new first flush tank with screening and disinfection
3. Outfall consolidation and routing of overflow to the GLWA Puritan Fenkell Retention Treatment Basin
4. A combination of 1 and 2, or 1 and 3.
5. Use of green stormwater infrastructure to reduce the scale of new grey infrastructure for 1, 2, 3 and 4.

Selection of one of the five solutions for the regional modeling does not preclude the implementation of a different solution. At the master planning level, each solution provides similar water quality benefits in terms of reduction of pathogens, reduction in oxygen-demanding pollutants, and prevention of discharging sanitary debris. The receiving water quality modeling performed for the evaluation of alternatives shows the relative impact of CSO controls and provided guidance for the relative timing of when controls should be implemented in conjunction with other stormwater management and CMOM initiatives. Therefore, even though only one of the five feasible solutions for the Redford Township Bell Branch CSOs was modeled, any of the five could be implemented and designed to achieve the same water quality result.

Table 6-7 Screening Criteria to Select Candidate Solutions for Modeling within Regional Alternatives

Category	Screening Criteria
Infiltration Inflow Management	The solution would reduce excessive infiltration inflow.
Member Level of Service	The solution helps to meet level of service requirements identified in Member survey or service contracts
Regional Capacity Management	The solution enables GLWA to improve regional capacity management for wet weather flows
Critical Hydraulic Grade Line Management	The solution provides additional control of flows or treatment capacity to reduce wet weather surcharging/

Category	Screening Criteria
Asset Management	The solution is consistent with the goals of GLWA's Strategic Asset Management Plan
Energy Efficiency	The solution reduces reliance on pumping, particularly repeated sequential pumping, in the regional collection system
Redundancy and Reliability	The solution improve redundancy for emergency purposes, and for efficiency of system rehabilitation solutions.
Climate Resiliency	The solution adds resiliency for potentially higher Detroit River, more intense rainfall and/or warmer temperatures
Optimizes	The solution optimizes the performance of existing facilities.
Committed Projects	The solution is already committed by GLWA or a Member to be implemented within the early years of the planning period.
Removal of Stormwater from Combined Sewers	The solution removes highway storm water from combined sewers in conjunction with highway modernization solutions
Green Infrastructure	The solution is driven by development ordinances that require stormwater controls including green infrastructure.
Beneficial infrastructure or recreational improvements to communities impacted by CSOs	The solution provides multiple benefits to communities impacts by CSO, or construction to control CSO. Multiple benefits, besides improved water quality, include new streetscapes, new recreational features, and new green infrastructure.
Affordability	The solution can be implemented as one step in sequence of integrated solutions that yield progressive water quality benefits at an investment pace that is affordable to the region.
Root cause	The solution addresses the root cause in the combined sewer infrastructure

6.5. Modeling of Regional Alternatives

The candidate solutions that remained after the screening process were incorporated into the collection system and receiving water quality modeling process. The Regional Wastewater Collection System (RWCS) SWMM model was used as the basis of modeling. Individual SWMM models were created to show progressive steps toward water quality improvement that could be achieved with phased implementation. At the end of the progressive steps, there are four complete regional alternatives that are designed to meet Michigan Water Quality Standards. Table 6-8 shows the assignment of candidate solutions to the individual models. The assignment of candidate solutions was performed in consultation with the Regional Collaboration Group, and the goal was to create models that represent regionally manageable and measurable implementation steps.

Table 6-8. Assignment of Candidate Solutions for Modeling in Regional Alternatives

Model Acronym	Builds On	Model Name	Candidate Solutions Simulated in Each Modeled Progression and Alternative
EXC		Existing Conditions	Actual operating conditions in 2018 (Used time series data from pump stations and VR operating rules in 2018.)
FUT	EXC	Future Conditions	MDOT's proposed projects including new GSI, sewer separation, and stormwater storage for Gordie Howe International Bridge, I-375 Improvements, I-75 South of 8 Mile, and I-75 North of 8 Mile

Model Acronym	Builds On	Model Name	Candidate Solutions Simulated in Each Modeled Progression and Alternative
			<p>Partial sewer separation for outfalls B018 and B042 performed in conjunction with MDOT projects</p> <p>Redevelopment-driven GSI in the City of Detroit based on ordinance requirements</p> <p>Modeled Fairview PS to maintain DRI level at 9 feet</p> <p>WRRF pump ON/OFF levels per NPDES Permit</p> <p>All In-System Storage Devices (ISDs) operating at 100% of design depth</p>
CM1	FUT	Phase 1 Collection System and MS4 Best Practices	Phase 1 Collection System and MS4 Best Practices to achieve dry weather dissolved oxygen standards and dry weather partial body contact standards.
NST	CM1	Non-Structural Optimization	<p>Regulator openings enlarged at 36 locations along the Detroit River Interceptor as proposed in the Interim Wet Weather Operating Plan (IWOP)</p> <p>VR-08 throttled to 86 cfs as proposed in the IWOP</p> <p>Increased operating level at ISD 005</p> <p>VR-17 operating rules updated per IWOP</p>
NBL	NST	New Baseline	<p>MCPWO Chapaton Basin Expansion</p> <p>Dearborn first flush capture and screening and disinfection facility at CSO-14</p> <p>Dearborn sewer separation at CSO-01, -03, and -04</p> <p>Fairview PS improvements (seven new 40 MGD pumps)</p> <p>RVSDS river inflow mitigated in accordance with the implementation of the Wayne County Long Term Corrective Action Plan</p> <p>Completion of remaining committed GSI projects by DWSD in Detroit</p>
OPT	NBL	Optimized Facilities	<p>NWI diversion to Oakwood RTB</p> <p>Meldrum Sewer connected to Leib SDF</p> <p>VR-15 and VR-16 programmed to close at high WRRF wet well levels (El 85) to divert flow from NIEA to Leib SDF.</p>
RD1	OPT	Rouge and Detroit Phase 1	<p>Dearborn Heights Ashcroft Drain area sewer separation</p> <p>Sewer separation for outfall B054 (West Warren) on the Rouge River and outfalls B003, B004, B005 and B006 (Fischer District) on the Detroit River</p> <p>Sewer separation at B018</p> <p>Phase 1 in-system storage on the Rouge River with nine new ISDs on the east side of the Rouge River</p> <p>Pilot Netting Facilities B-020 and B-023</p>

Model Acronym	Builds On	Model Name	Candidate Solutions Simulated in Each Modeled Progression and Alternative
CM2	RD1	Phase 2 Collection System and MS4 Best Practices	Phase 2 Collection System and MS4 Best Practices to achieve dry weather dissolved oxygen standards and dry weather full body contact standards.
RD2	CM2	Rouge and Detroit Phase 2	<p>Redford Ashcroft Drain CSO outfall consolidation, first flush capture and screening and disinfection facility</p> <p>Six Redford Township CSOs on Bell Branch routed to Puritan Fenkell RTB</p> <p>Inkster and Dearborn Heights Lower Rouge Separation and/or Extend RTB Service Areas</p> <p>New Phase 2 CSO Control Conduit for Rouge River</p> <p>Sewer separation on the Detroit River (B007, B009, B010, and B017) and Rouge River (Glenhurst (B082), Ray & Brammel (B071), Lyndon (B072), Schoolcraft and Outer Drive (B069/B070), Puritan (B077), Plymouth (B064), West Chicago (B063), Florence & Ridge (B079))</p> <p>Sewer separation in Detroit east of Rouge River in the service areas tributary to the Puritan, Fenkell and Lyndon CSO outfalls.</p>
CM3	RD2	Phase 3 Collection System and MS4 Best Practices	Phase 3 Collection System and MS4 Best Practices to achieve all water quality standards.
RD3	CM3	Rouge and Detroit Phase 3 (Recommended Plan, plus adaptive elements from RDA)	Installation of netting and in-line disinfection for remaining CSO outfalls that exceed regulatory criteria for Extreme Event or Minimum Volume discharges.
POR	NBL, CM3	Plan of Record 2008 LTCSO Plan and 2010 Supplement	Construction of first flush basins, netting facilities and in-line disinfection for Rouge River CSO outfalls in accordance with the 2010 LTCSO Plan Supplement. Construction of the Meldrum Sewer diversion to the Leib SDF; construction of netting and in-line disinfection facilities for Detroit River CSO outfalls in accordance with the 2008 LTCSO Plan. CSO outfalls designated as Minimum Volume or Extreme Event only discharges subsequent to 2010 LTCSO plan would not have new controls.
CON	OPT, CM3	New Conveyance Alternative	New relief conduits to provide additional capacity to convey wet weather flow at the WRRF, new Pump Station 3 and high rate clarification at the WRRF.
GSI	RD1	Maximum GSI	Construction of 15,300 acres of GSI within public rights of way on Detroit's West, Central, and East Districts.
RDA	GSI	Maximum GSI and Reduced DWII	DWII reduced by 50% by improvements to DWSD distribution mains and GLWA water transmission mains, reductions in river inflow, and excessive I/I in Member systems
SEP	FUT CM3	Full Separation	Separation of all 233 acres of combined sewer area in the GLWA regional system.

6.6 Collection System Alternatives Scoring Methodology

A scoring methodology was developed to evaluate collection system alternatives. The methodology derives from the 5 desired outcomes developed for the Wastewater Master Plan as

discussed in Section 2. In comparing costs and benefits of alternatives, the 5 desired outcomes represent benefits, and the scoring methodology provides the means to measure the benefits. This section describes the development and application of the scoring methodology.

The seven-month period of April 1 through October 31, 2018 was selected as the continuous simulation period because it is a recent period with a large amount of system operation and monitoring data. This seven-month interval is the period of the year that is of most interest for examining compliance with water quality standards given partial and full body contact recreation during these months. This period in 2018 was a relatively wet period with 10 storms exceeding 1-inch depth and a total of 28.5 inches of rainfall. This time period had been used to document the performance of the West Side Model in a recent deliverable to EGLE and continuous river boundary conditions were available for modeling.

6.6.1 Attainment Measures

A set of attainment measures was developed in consultation with the Steering Team and Regional Collaboration Group. Meetings with EGLE were held to obtain input on how the attainment measures could be interpreted for regulatory compliance.

The attainment measures indicate progress toward achieving the 5 desired outcomes. Higher attainment measure scores indicate a greater degree of progress toward the respective desired outcomes. Table 6-9 provides a list of the attainment measures and the computational method. A description of each attainment measure is presented below. Additional detail is provided in Technical Memorandum 6A.

6.6.2 Percent of Time Achieving Partial Body Contact Use

The Attainment Measure for Partial Body Contact Use is calculated by the receiving water quality model. The score is based on *E. coli* compliance calculated as the percentage of time meeting the partial body (1,000 cfu/100 ml) water quality standards. The statistics are calculated for each model segment and all model timesteps, where the percentage of time is the number of timesteps meeting each standard compared against the total model timesteps. These metrics are aggregated into a single number for each receiving water, weighted by river mile, and then into a single regional weighted value by the relative length of river in the Detroit and Rouge systems.

6.6.3 Percent of Time Achieving Full Body Contact Use

The attainment measure for Full Body Contact Use is calculated by the receiving water quality model. The score is based on *E. coli* compliance calculated as the percentage of time meeting the partial body (300 cfu/100 ml) water quality standards. The statistics are calculated for each model segment and all model timesteps, where the percentage of time is the number of timesteps meeting each standard compared against the total model timesteps. These metrics are aggregated into a single number for each receiving water, weighted by river mile, and then into a single regional weighted value by the relative length of river in the Detroit and Rouge systems.

Table 6-9. Attainment Measures

Desired Outcome	Attainment Measure	Key Objective	Computational Method Simulation Period
-----------------	--------------------	---------------	---

Protect Public Health and Safety	% of Time achieving Partial Body Contact Use	Meet Water Quality Standards	% of time <i>E. Coli</i> ≤ 1000 (River Mile Weighted)
Protect Public Health and Safety	% of Time Achieving Full Body Contact Use	Meet Water Quality Standards	% of time <i>E. Coli</i> ≤ 300 (River Mile Weighted)
Preserve and Enhance Natural Resources	% of Time Achieving Aquatic Life Use	Meet Water Quality Standards	% of time D.O. > 5 (Rouge) % of time D.O. > 7 (Detroit) (River Mile Weighted)
Preserve and Enhance Natural Resources	% of Rouge River Outfalls with First Flush Capture	Meet Water Quality Standards	Inventory of outfalls protected by first flush capture facilities
Protect Public Health and Safety Maintain High Quality Service	% of Time achieving Critical Hydraulic Grade Line	Reduce the Risk of Sanitary Sewer Overflow and Basement Flooding	% of time HGL below critical elevations for all areas monitored to protect from SSO and basement flooding.
Provide Value for Investment Maintain High Quality Service	% Wet Weather Flow Capture	Minimize Sewer Overflows	% of CSO and SSO volume treated during precipitation events
Provide Value for Investment	% of Existing CSO Facility Design Capacity Utilized	Maximize Use of Existing Treatment Facilities	% of Overflow events when remote treatment facilities utilize more than 80% of design capacity
Provide Value for Investment Maintain High Quality Service	Value-Added Improvements to Existing Facilities	Maximize Improvements to Existing Infrastructure	% of Potential Improvements to Existing Facilities
Contribute to Economic Prosperity	Value-Added Benefits for Impacted Communities	Maximize Benefits to Impacted Communities	% of Potential Benefits for Tributary Area

6.6.4 Percent of Time Achieving Aquatic Life Use

The Attainment Measure for Aquatic Life Use is calculated by the receiving water quality model. It is only measured for the Rouge River, because CSO discharges do not impact dissolved oxygen in the Detroit River. The score is based on the percentage of time that each segment meets the 5 mg/l dissolved oxygen standard. The statistics are calculated for each model segment and all model timesteps, where the percentage of time is the number of timesteps meeting each standard compared against the total model timesteps. These metrics are aggregated into a single number weighted by river mile, and then into a single regional weighted value over the length of the Rouge River.

Water quality scores are computed for the entire model simulation period (not just during the NPDES permit defined Wet Weather events).

6.6.5 Percent of Rouge River Outfalls with First Flush Capture

The Attainment Measure for Rouge River Outfalls with First Flush Capture is calculated by a count of the outfalls and their respective CSO control technology. The percentage of outfalls is based on the total All existing CSO control facilities on the Rouge River include first flush controls, except

for the Baby Creek Screening and Disinfection Facility. Existing uncontrolled CSOs with an NPDES permit category of Minimal Volume and Extreme Event Only were not counted in the percentage. Where sewer separation is included in an alternative, then the separated CSO outfall is counted as achieving first flush capture.

6.6.6 Percent of Time Achieving Critical Hydraulic Grade Line

The Attainment Measure for Critical Hydraulic Grade Line is calculated by the hydrology and hydraulic model (Regional Wastewater Collection System Model, or RWCS Model). The critical hydraulic grade line protection score is calculated as the percentage of time that the HGL at designated critical locations is below an elevation threshold measured with the NAVD88 datum. This statistic is computed for the entire simulation period, not just the wet weather events. The measure calculated so that a day is considered an “exceedance” if any node within the critical nodes exceeds a critical elevation. Most HGL thresholds are set to the pipe crown, with several locations along the Northwest Interceptor set to allow ten feet of surcharge. Critical hydraulic grade line elevations were reviewed with Member representatives of the Regional Collaboration Group.

6.6.7 Percent Capture of Wet Weather Flow

The Attainment Measure for Percent Capture is calculated by the hydrology and hydraulic model (Regional Wastewater Collection System Model, or RWCS Model). Percent capture is defined as the percentage of stored or treated wet weather flow volume during wet weather events. The events are defined in the GWLA/DWSD NPDES permit:

For the interim period, is defined as those days on which an average 0.10 inches or more of precipitation was recorded by six strategically located rainfall gauges (as defined in Part I.9.c.(10) of the Operational Plan) in the WRRF’s service area, plus two days immediately following days of 0.10 inch to 1.00 inch days of precipitation or three days following days of 1.00 inch or more precipitation. Rainfall days are further limited to those days in which the air temperature exceeds 32° F (0° C) for at least an eight-hour period. The permittee may demonstrate that certain events such as snowmelt, and other unforeseen events will be considered rainfall days.

6.6.8 Percent of Existing CSO Facilities Activated During Wet Weather Events

The attainment measure for Percent of Existing CSO Facilities Activated is calculated by the hydrologic and hydraulic model (Regional Wastewater Collection System Model, or RWCS Model). A facility capacity activation is counted if the peak flow exceeds 0.1 cfs. For each wet weather event, the number of existing CSO facilities activated was divided by the total number of existing CSO facilities as listed in Table 6-10.

Table 6-10 Design Capacities Used for Calculating Percent of Capacity Utilized

Facility Name	Volume Capacity (Million Gallons)	Peak Flow Capacity (Cubic Feet Per Second)
Belle Isle RTB	0.3	66
Leib SDF	9.94	1,550
St Aubin SDF	2.43	250
Baby Creek SDF	28	5,100

Facility Name	Volume Capacity (Million Gallons)	Peak Flow Capacity (Cubic Feet Per Second)
Milk River RTB	18.8	1,920
Chapaton RTB	28	1,545
Martin RTB	8.6	410
Acacia Park RTB	4.4	290
Birmingham RTB	5.5	330
Bloomfield Village RTB	10	700
George W Kuhn RTB	92	6,700
Inkster RTB	3.1	500
Middlebelt Road RTB	1.3	405
Dearborn Heights RTB	2.7	500
Redford Township RTB	1.7	190
Dearborn C4	2.4	Capture Shaft, no treatment capacity
Dearborn C7	6.2	936
Dearborn C8	7.5	1,047
Oakwood RTB	9	1,660
Conner Creek RTB	31.5	13,962
Hubbell-Southfield RTB	22	2,200
Puritan-Fenkell RTB	2.8	655
Seven Mile RTB	2.2	494
Dearborn C6	6.5	1,867

6.6.9 Asset Management Score

The Attainment Measure for Asset Management is a qualitative measure of the way each alternative or alternative step improves existing infrastructure. Each alternative or alternative step is rated on the following scale, with 5 being the highest potential value:

- 1 = Maintains existing condition of infrastructure
- 2 = Improves the frequency of inspection of existing infrastructure
- 3 = Rehabilitates existing infrastructure in conjunction with new wet weather controls
- 4 = Repurposes or optimizes existing infrastructure to improve wet weather controls
- 5 = Supports early investment to improve existing infrastructure

The scoring was assigned as a value-added metric. Improvements to the condition of existing wastewater infrastructure are being prioritized by GLWA and its Members. Maximum scores were given to progressive steps along the adaptive integrated plan that minimize near term costs for new facilities, and thus allow use of GLWA capital improvement resources for rehabilitation of existing facilities.

Scores for pre-planning period time steps are based on judgment from the Regional Collaboration Group. Prior to the recession of 2008, particularly when more grant funding was available and the

infrastructure was newer, the judgment was that wastewater assets were sufficiently maintained. During the recession that began in 2008, expenditures for inspection and rehabilitation were reduced, which jeopardized the condition of existing infrastructure. The creation of GLWA in 2016 established new policies and funding priorities for asset management and re-investment.

6.6.10 Contribution to Economic Prosperity

The attainment measure for Contribution to Economic Prosperity is a qualitative measure of the way each alternative provides benefits to communities impacted by local wet weather water quality and level of service of existing infrastructure. Each alternative is rated on the following scale, with 5 representing the highest potential value:

- 1 = Maintains existing level of service and local community features
- 2 = Provides improvements early in the planning period to impacted communities
- 3 = Improves streets and level of service
- 4 = Adds green stormwater infrastructure and other development improvements
- 5 = Supports progressive expenditures consistent with regional affordability

The scoring was assigned as a value-added metric. These scores were assigned based on the qualitative guidance provided by the US EPA publication: *Characterizing the Value of Water to Inform Decision-Making*. August 2017. This document examines the challenges that urban areas face in operating wastewater and stormwater infrastructure under Clean Water Act (CWA) requirements and financial constraints. Agencies with multiple CWA obligations must prioritize their investments. The integrated planning process allows for systematically identifying and prioritizing actions and projects to meet CWA obligations. A fundamental premise of prioritizing actions is the value that water resource improvements create for communities currently impacted by impaired water quality. The US EPA document characterizes the value of water and applies that value to inform integrated wastewater and stormwater planning.

The US EPA document uses examples cities and counties in Missouri to develop measures for comprehensive integrated planning. These measures include:

- Economic value of major commercial water users – Blue Economy
- Economic value of water-related recreation
- Improvement in property values and related new development
- Value of green infrastructure in the impacted areas

These generic measures were applied more specifically to the needs of GLWA's service area through the 1 to 5 scale cited earlier. These measures are consistent with the goals of the existing Green Infrastructure Program of the NPDES permit for GLWA and DWSD.

6.6.11 Weighting Factors for Attainment Measures

Each Attainment Measure has an associated weighting factor that is used to calculate a total Desired Outcome Progress Score for each alternative and each progression step. The weighting factors were developed in consultation with the Regional Collaboration and Steering Team. A series of “what-if” scenarios were demonstrated to show the impact of changing weighting factors.

6.7 Scoring Results

Attainment scores were developed in an iterative process by performing the continuous simulations, reviewing results with the Regional Collaboration Group, making model refinements and re-simulating. The iterative process facilitated detailed interaction with GLWA staff and Members. The process also allowed for continuing improvements to operating rules and model physical representation of the collection system.

The modeling results for September 2019 are shown in Decision Support Framework Table 6-11. A future version of this report will present a final set of November 2019 model results.

Table 6-11. Decision Support Framework Scoring of Regional Alternatives

Decision Support Framework Scoring December 31, 2019					Past Progress					Future Baseline	Phase 1 Collection System and MS4 Best Practices	Progressive Near Term System-Wide Control Steps			Phase 1 CSO Controls	Phase 2 Collection System and MS4 Best Practices	Phase 2 CSO Controls	Phase 3 Collection System and MS4 Best Practices	Phase 3 CSO Controls	Guidance for Adaptive Elements		Other Alternatives to Meet the Water Quality Requirements				
					Health & Safety	Natural Resources	Quality Service	Value of Investment	Economic Prosperity	Attainment Measure	Weighting Factor	1980 to 1989	1990 to 1999	2000 to 2009	2010 to 2019	Existing Conditions (EXC)	Future Conditions (FUT)	Base Flow & Stormwater Improved for Dry Weather Partial Body Contact (CM1)	IWOP / ROP (NST)	Committed Projects (NBL)	Wet Weather Facility Optimization (OPT)	Public Health Protection for Small Storms (RD1)	Base Flow & Stormwater Improved for Dry Weather Full Body Contact (CM2)	Extend Protection for Public Health and Aquatic Species (RD2)	Base Flow & Stormwater Improved for all Water Quality Standards (CM3)	Extend Protection for Extreme Wet Weather Events (RD3)
					% of Time achieving Partial Body Contact Use	5%	45%	50%	65%	66%	66%	66%	91.3%	91.3%	92%	92%	92.2%	99.5%	99.5%	99.7%	99.9%	92.8%	92.7%	99.9%	99.9%	100%
					% of time achieving Full Body Contact Use	5%	8%	15%	24%	24.8%	24.8%	24.8%	39.2%	39.3%	39.5%	39.5%	38.9%	84.4%	84.4%	98.7%	99.9%	39.8%	39.6%	99.9%	99.9%	100%
					% of Time achieving Aquatic Life Use (DO WQS)	10%	80%	85%	90%	94.6%	94.6%	94.6%	94.7%	96.7%	95.2%	95.2%	95.4%	96.7%	96.8%	96.8%	96.8%	95.4%	95.5%	95.9%	96.8%	96.8%
					% of Rouge River Outfalls with First Flush Capture	10%	0%	6.7%	20%	35%	35%	35%	35%	35%	35%	35%	73.3%	73.3%	100%	100%	100%	73.3%	73.3%	100%	100%	100%
					Asset Management Score	15%	60%	50%	25%	30%	35%	37.2%	39.4%	50.6%	61.7%	72.8%	83.9%	95%	97.2%	99.4%	99.9%	99.4%	99.9%	77.2%	77.2%	24.4%
					% of Existing CSO Facility Activated during Wet Weather Events	10%	45%	45%	50%	70.5%	70.5%	70.2%	70.2%	70.3%	70.8%	70.5%	70.3%	70.3%	70.3%	70.3%	70.3%	67%	67.7%	70.8%	70.3%	70.3%
					% of time achieving Critical HGL Protection	15%	70%	75%	85%	87.6%	87.6%	87.7%	87.7%	90.2%	90.7%	91.2%	91.3%	91.3%	91.3%	91.3%	91.3%	92.1%	93%	90.2%	89%	89%
					% Capture	20%	60%	85%	95%	96.5%	96.5%	96.4%	96.4%	96.7%	97.9%	98.1%	98.8%	98.8%	99.2%	100%	100%	99.3%	99.3%	100%	96.7%	100%
					Economic Prosperity Score	10%	50%	50%	25%	25%	30%	32.2%	34.4%	45.6%	56.7%	67.8%	78.9%	90%	94.4%	96.7%	96.7%	92.2%	94.4%	72.2%	72.2%	24.4%

Decision Support Framework Scoring
December 31, 2019

Desired Outcomes					Past Progress						Future Baseline	Progressive Near Term System-Wide Control Steps			Phase 1 CSO Controls	Phase 2 Collection System and MS4 Best Practices	Phase 2 CSO Controls	Phase 3 Collection System and MS4 Best Practices	Phase 3 CSO Controls	Guidance for Adaptive Elements		Other Alternatives to Meet the Water Quality Requirements				
					Attainment Measure	Weighting Factor	1980 to 1989	1990 to 1999	2000 to 2009	2010 to 2019	Existing Conditions (EXC)	Future Conditions (FUT)	Base Flow & Stormwater Improved for Dry Weather Partial Body Contact (CM1)	IWOP / ROP (NST)	Committed Projects (NBL)	Wet Weather Facility Optimization (OPT)	Public Health Protection for Small Storms (RD1)	Base Flow & Stormwater Improved for Dry Weather Full Body Contact (CM2)	Extend Protection for Public Health and Aquatic Species (RD2)	Base Flow & Stormwater Improved for all Water Quality Standards (CM3)	Extend Protection for Extreme Wet Weather Events (RD3)	Maximum GSI (GSI)	Max GSI + Reduced DWII (RDA)	Plan of Record with Collection System and MS4 Best Practices (POR)	New Larger Interceptors and Increased Treatment at WRRF (CON)	Complete Sewer Separation (SEP)
Health & Safety	Natural Resources	Quality Service	Value of Investment	Economic Prosperity				EXC	FUT	CM1	NST	NBL	OPT	RD1	CM2	RD2	CM3	RD3	GSI	RDA	POR	CON	SEP			
					Outcome Progress Score	100%	51.7%	57%	56.5%	60.5%	61.7%	62.3%	64.8%	68.2%	71.3%	74.1%	77.1%	82.6%	83.5%	84.9%	85%	80.7%	81.2%	79%	78.2%	66.2%
					Incremental Capital Cost (2019 \$ Millions)		\$318	\$702	\$1,762	\$653	\$ -	\$3	\$6	\$14	\$267	\$213	\$450	\$10	\$1,156	\$20	\$150	\$4,640	\$2,500	\$1,859	\$3,384	\$15,000
					Cumulative Capital Cost (2019 \$ Millions)		\$318	\$1,020	\$2,782	\$3,436	\$ -	\$3	\$9	\$23	\$290	\$503	\$952	\$962	\$2,118	\$2,138	\$2,288	\$5,173	\$7,673	\$2,156	\$3,627	\$15,039
					Incremental Annual Cost (2019 \$ Millions)		\$ -		\$ -	\$ -	\$ -	\$0	\$11	\$0	\$2	\$2	\$1	\$10	\$3	\$10	\$3	\$1	\$9	\$29	\$29	\$10
					Cumulative Annual Cost (2019 \$ Millions)		\$ -	\$ -	\$ -	\$ -	\$ -	\$0	\$11	\$11	\$13	\$15	\$16	\$26	\$29	\$39	\$42	\$36	\$45	\$51	\$51	\$41
					Incremental Life Cycle Present Worth (2019 \$ Millions)		\$318	\$702	\$1,762	\$653	\$ -	\$3	\$177	\$10	\$129	\$161	\$190	\$174	\$513	\$184	\$177	\$4,308	\$1,222	\$1,727	\$2,023	\$5,039
					Historical Perspective: Cumulative Life Cycle (2019 \$ Millions)		\$318	\$1,020	2,782	\$3,436	\$ 3,436	\$3,438	\$3,615	\$3,625	\$3,754	\$3,915	\$4,105	\$4,279	\$ 4,792	\$4,976	\$5,152	\$8,580	\$9,803	\$5,649	\$5,977	\$9,011
					No Pre-Planning Period Costs: Cumulative Life Cycle (2019 \$ Millions)						\$ -	\$3	\$ 180	\$189	\$319	\$480	\$670	\$843	\$ 1,356	\$1,540	\$1,717	\$5,145	\$6,367	\$2,213	\$2,541	\$5,575

Figure 6-1 shows the costs and benefits for the four alternatives that meet the Michigan water quality standards. These four alternatives are:

1. Separate the sewers in the 233 square mile combined sewer service area (SEP).
2. Expand pumping and treatment capacity at the WRRF for additional wet weather flow and construct major relief sewers to carry first flush wet weather flow to the WRRF (CON); install netting and disinfection at outfalls that exceed NPDES limit criteria for Minimal Volume or Extreme Event discharge.
3. Implement the Plan of Record (POR) as presented in the 2008 Long Term CSO Control Plan and its 2010 Supplement. This plan would construct 7 new RTBs along the Rouge River and a series of netting and inline disinfection facilities.
4. Maximize the use of green stormwater infrastructure (GSI) by constructing over 8,500 acres of sewer separation, disconnecting 90% of downspouts, and constructing over 15,300 acres of GSI in public rights-of-way.
5. Implement an Integrated Adaptive Management solution (RD3) that creates water quality improvement for each step of implementation, and implementation can be paced at the affordability of the region.

The costs shown in Figure 6-1 represent the estimated capital costs for each alternative. The desired outcome progress score represents the weighted value of all attainment measures. All five alternatives include the programs for Collection Systems and Separate Storm Drain Best Practices to provide dry weather and MS4 water quality protection.

The Integrated Adaptive Management alternative has the lowest present worth cost and the highest Desired Outcome Progress Score.

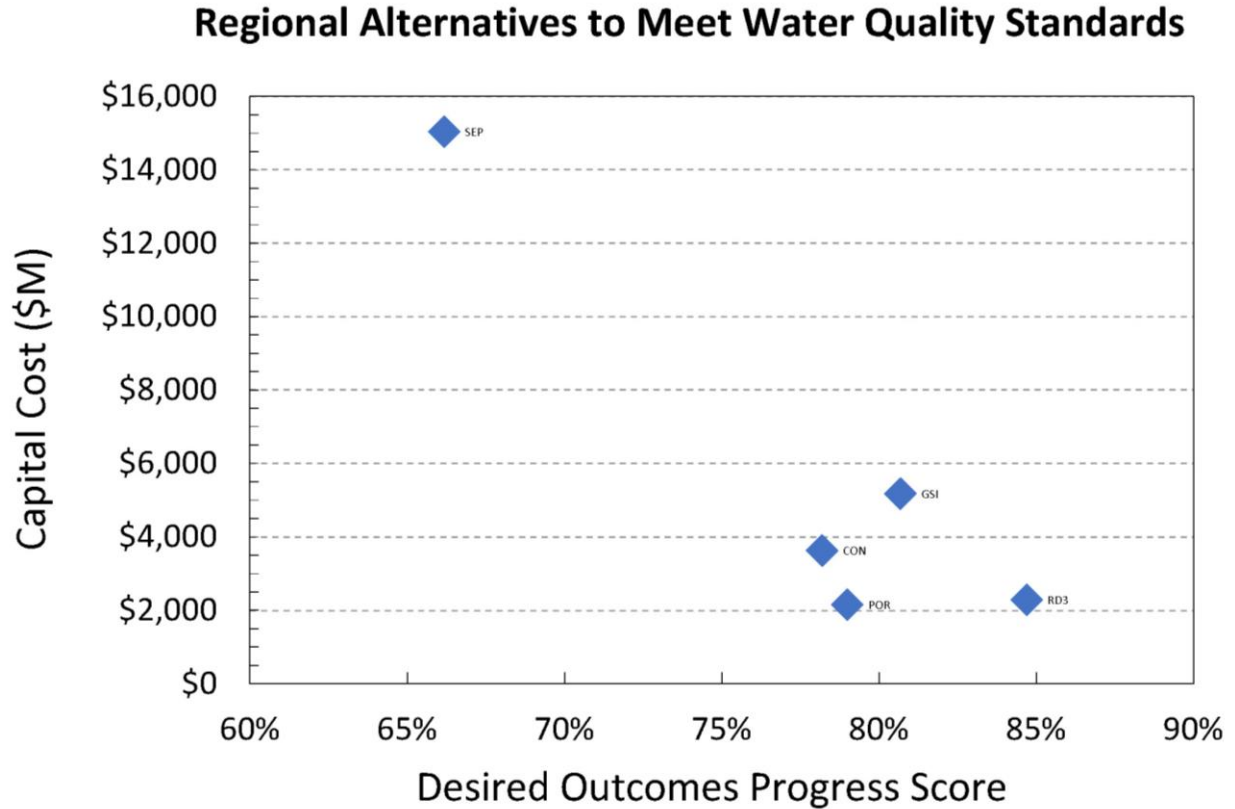

Figure 6-1. Cost and Benefit Curve for Regional Collection System Alternatives that Meet Michigan Water Quality Standards

Figure 6-2 shows the costs and benefits for each step of the progression that implements the Integrated Adaptive Management alternative. The cost-benefit curve displays a “knee of the curve” inflection point which is typical for wet weather water quality control programs. RD1, which is the completion of Phase 1 optimization, in-system storage and sewer separation, To the left of the knee of the curve, progress toward the Desired Outcomes is attained at a rate that exceeds the increases in cost to improve the Desired Outcome score. To the right of the knee of the curve, progress toward the Desired Outcomes proceeds at diminishing rates, while the costs increase at higher rates.

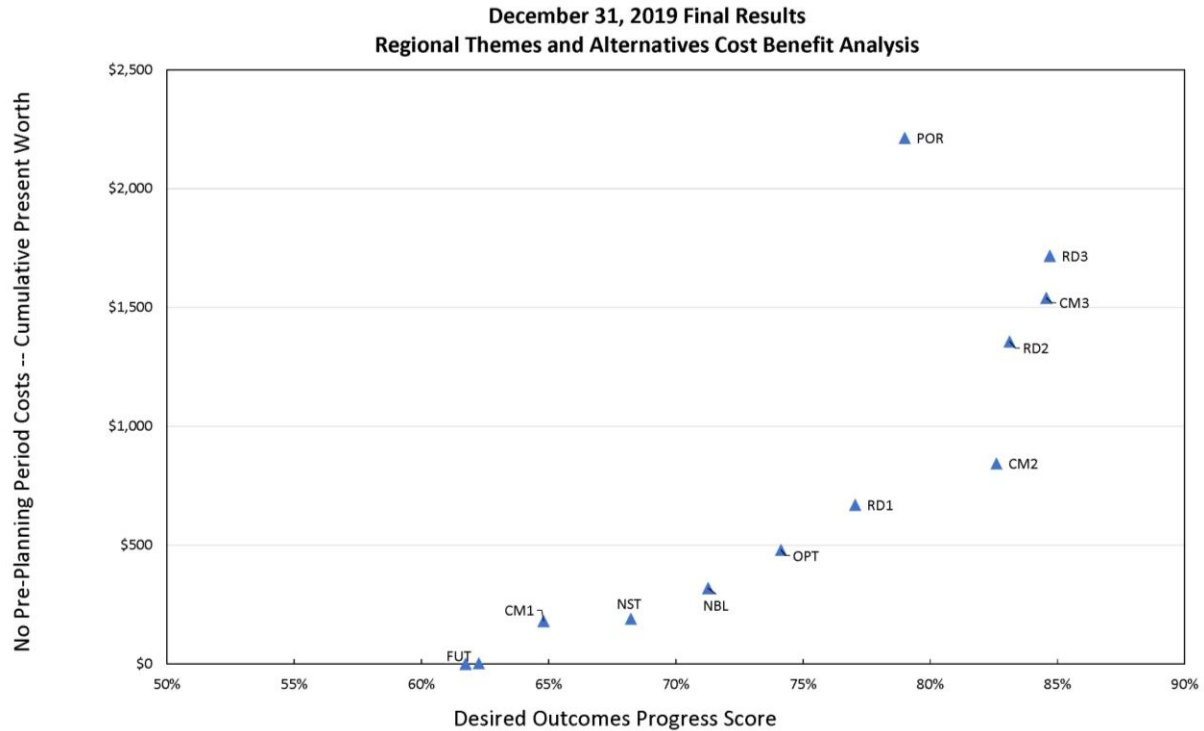

Figure 6-2. Cost and Benefit Curve for Progressive Steps along the Integrated Adaptive Management Alternative to Meet Michigan Water Quality Standards

6.8 Phasing of Proposed Projects

The scoring results shown in Table 6-11 and the graphical representation in Figure 6-2 provide guidance for sequencing of regional water quality protection projects. Programming the projects in three major phases is envisioned, as shown in Table 6-12.

Table 6-12. Phasing of Proposed Projects

Phase	Water Quality Goals	Major Projects
Phase 1		<ul style="list-style-type: none"> Scheduled asset management projects by GLWA and Members
Rouge River	Achieve Dry Weather DO and Partial Body Contact Standards Reduce Public Health Risks and DO drops by Small Storm Capture	<ul style="list-style-type: none"> Committed CSO control projects IWOP recommendations for operating rules and Detroit River Interceptor regulator improvements. Regional Operating Plan and Regional Water Quality Monitoring Program
Detroit River	Reduce Public Health Risks by Small Storm Capture with Improved Conveyance Capacity	<ul style="list-style-type: none"> Northwest Interceptor Diversion to Oakwood RTB Meldrum Sewer Diversion to Leib Screening and Disinfection Facility In-System Storage on DWSD Trunk Sewers Tributary to the Rouge River Sewer Separation for designated areas where collaborative opportunities with MDOT and Member partners

Phase	Water Quality Goals	Major Projects
		<ul style="list-style-type: none"> Pilot netting facilities on Detroit River outfalls upstream of Ralph C. Wilson Jr. Centennial Park
Assess water quality trends, priority problem areas, advances in private property and public GSI implementation, CSO percent capture. Update the Phase 2 plan based on results achieved in Phase 1.		
Phase 2		
Rouge River	Achieve Full Body Contact Standards during Dry Weather Achieve Aquatic Species Protection during Wet Weather	<ul style="list-style-type: none"> Rouge River CSO Control Conduit Suburban CSO control projects in Redford Township, Dearborn, Dearborn Heights and Inkster Continue sewer separation projects in City of Detroit
Detroit River	Public health and sanitary trash protection for priority recreational areas	
Assess water quality trends, priority problem areas, advances in private property and public GSI implementation, CSO percent capture. Update the Phase 2 plan based on results achieved in Phase 1.		
Phase 3		
Rouge River	Attain full water quality standards	Netting and disinfection for outfalls with discharges that exceed NPDES criteria for Minimal Volume or Extreme Events
Detroit River		Complete sewer separation projects in City of Detroit

6.9 Collection System Capacity Assessment

The first of the five planning Outcomes is to “Protect Public Health and Safety”. Managing the collection system capacity and managing the hydraulic grade line at critical locations are fundamental operating requirement in meeting this first Outcome.

Reducing the risk of basement flooding is a shared responsibility of property owners, each municipality, each County wastewater conveyor, and GLWA. This Wastewater Master Plan included an investigation of GLWA’s critical assets to determine if the capacity, operation, or condition of the asset poses a risk of basement flooding now or over the 40-year planning period.

The analysis of needs for GLWA’s role in basement flooding risk management was performed through the following series of tasks:

1. Level of Service Goal
2. Potential Impacts of Climate Change
3. Critical Hydraulic Grade Elevations at Major Connection Points
4. Estimate of Trunk Sewer and Interceptor Capacity

6.9.1 Level of Service Goal

The interceptors and trunk sewers leased by GLWA are located within the municipal limits of Detroit, Dearborn, Hamtramck and Highland Park. The trunk sewers leased by GLWA were

generally designed to convey flow for a 10-year 1-hour storm. (There are some exceptions to the 10-year storm level of service as described later). Interceptors were designed to convey 2 to 3 times the average dry weather flow from the tributary area.

A 10-year 1-hour storm event will generally be used as the level of service goal for GLWA leased trunk sewers.

A 10-year 1-hour storm event will be used as the basis of design for planning new storm sewer capacity for separation projects.

Interceptor surcharging is generally relieved by overflows through combined sewer outfalls.

The level of service goal for operation of interceptors will be to provide sufficient pump redundancy, optimization of regulator capacities, and active control points to maintain hydraulic grade lines in the regional collection system at or below critical elevations

6.9.2 Potential Impacts of Climate Change

A Detroit River elevation of El 98.0 has traditionally been used for design conditions for WRRF capacity and pumping requirements. However, the Detroit River reached El 98.6 in July 2019. Basement flooding protection will be assessed relative to the historic El 98.0 design elevation, and projected new levels of El 99.0 and El 99.5.

6.9.3 Critical Hydraulic Grade Line Elevations

Table 6-13 presents a preliminary identification of Critical Hydraulic Grade Elevations at Member Billing Meters, within the DWSD wastewater collection system, and at GLWA regional and CSO control facilities. These elevations were the basis for scoring the Attainment Measure of Critical Hydraulic Grade Control in the evaluation of alternatives for the Wastewater Master Plan. These elevations were reviewed and adjusted based on Member and GLWA comments received between April and January 2020.

Starting in the year 2020, these critical locations and elevations should be reviewed annually based on annual performance of the system and recordings of level sensors at or near these locations. The critical elevations should be updated as needed to improve regional system performance.

Table 6-13. Critical Elevations

Member	Meter(s) or Location (Model Junction ID)	Interceptor or Trunk Sewer Name	Cross Streets	Elevation (Feet) (NAVD88)			Criteria for Critical HGL
				Interceptor Invert	Critical	Ground	
MEMBER BILLING METER LOCATIONS							
Allen Park	AP-S-1 (SMH62496)	Northwest Interceptor	Enterprise Drive and South Dearborn Drive	556.8	578.5	599.7	Pump Station Design Criteria
	AP-S-2 (SMH62566)	Northwest Interceptor	Fairlane Drive and Fairlane Circle	557.4	580.0	586.8	Tributary area is industrial park without basements. 6-feet below grade.
Center Line	CL-S-1 (SMH16630)	Van Dyke Interceptor	8 Mile and Van Dyke	604.4	611.2	621.3	Crown of Pipe
Dearborn	DN-S-2 (SFIT0014)	Northwest Interceptor	Greenfield Road and Butler Street	556.0	574.25	589.4	Greenfield Pump Station Design Criteria
	DN-S-4 (SMH62452)	Northwest Interceptor	Southfield Freeway and Hubbard Drive	562.8	591.9	600.2	Crown of Pipe
	DN-S-5 (JCT-982)	Northwest Interceptor	Southfield Freeway 1,000 feet north of Garage Road	561.9	576.5	600.2	
	DN-S-6 (JCT-428)	Northwest Interceptor	Michigan Avenue 700 feet west of American Drive	560.5	584.6	598.6	Invert of 12" sewer u/s of meter on Dearborn Record Drawing 533793 Detail B
	DN-S-7 (JCT-1392)	Northwest Interceptor	Ford Rd and Altar Rd	567.2	592.8	611.7	Invert of 12" sewer d/s of meter at drop connection to NWI
	DN-S-8 (20319)			300 ft NW of Miller Rd and Bland St	569	572.5	585.0
Farmington	FA-S-1 (JCT-2176)	NWI	8 Mile and Berg Rd	613.87	620.87	640.95	Crown of Pipe
Grosse Pointe	GP-S-1 (FCMH11)	Fox Creek Enclosure	Charlevoix St and Neff Rd	562.77	574.35	580.46	Crown of Pipe
Grosse Pointe Farms	GPF-S-1 (SFIT3070)	Grosse Pointe Interceptor	Chalfonte Ave and Kerby Rd	565.2	569.2	582.2	Crown of Pipe
Grosse Pointe Park	GK-S-1,2 (SFIT0083)	Fox Creek Enclosure	Jefferson Ave and Maryland Street	559.7	567.7	578.3	Crown of Pipe
Melvindale	ME-S-1 (SMH62563)	Northwest Interceptor	Greenfield Road 800 feet east of	555.2	571.3	583.9	Pump Station Design Criteria

Member	Meter(s) or Location (Model Junction ID)	Interceptor or Trunk Sewer Name	Cross Streets	Elevation (Feet) (NAVD88)			Criteria for Critical HGL
				Interceptor Invert	Critical	Ground	
			Prospect Street				
Oakland County: Evergreen-Farmington	OC-S-1 (SOT136017)	First Hamilton Relief Sewer	Southfield Rd and West Haven Ave	618.3	636.6	657.9	Crown of Pipe
Oakland County: SE Oakland	SE-S-1 (SCH00080)	8 Mile and Dequindre St	Conant-Mt. Elliot Sewer	589.6	598.6	629.8	Crown of Pipe
Oakland Macomb Interceptor Drain	NES-S-DWP,1,2,4,5,6 (SMH10962)	NIEA	2,600 feet SW of 8 Mile Road and Hoover Street	574.7	592.2	619.3	Crown of Pipe
Southeast Macomb Sanitary District	Kerby Road Pump Station (Kerby Magmeter)	Kerby Rd Interceptor	Chalfonte Avenue and Kerby Road		576.75		Crown of Fox Creek Enclosure
Southeast Macomb Sanitary District	WM-S-1 (SFIT3070)	Gross Pointe Interceptor	Chalfonte Avenue and Kerby Road	565.2	569.2	582.2	Crown of Pipe
Wayne County: Rouge Valley	WC-S-1 (3005)	Northwest Interceptor	Fort St W and S Oakwood Blvd	554.4	569.2	583.3	WRRF PS1 and PS2 wet well
	WC-S-2 (JCT-1788)	Northwest Interceptor	Evergreen Rd and Ford Road	568.2	587.0	615.6	At Wayne County JC-18A
	WC-S-3 (JCT-982)	Northwest Interceptor	500 feet west of North Rd and West Road	561.9		600.2	
DWSD COLLECTION SYSTEM LOCATIONS							
	L033 (SMH05262)	Mack Ave Sewer	Mack Ave Kensington Ave	551.5	560.8	582.0	Crown of Pipe
	L063 (SFIT0079)	7 Mile Sewer	7 Mile Road Van Dyke Street	595.1	608.1	621.9	Crown of Pipe
	L098 (ISD013_US)	7 Mile Sewer	7 Mile Road Maine St	604.3	615.8	629.7	Crown of Pipe
	L118 (DR02_US)	Livernois Sewer	Livernois Ave Ranspach Street	565.9	576.4	588.3	Crown of Pipe
	L156 (SMH32696)	Joy Sewer	Joy Road Epworth Street	586.4	600.4	618.5	Crown of Pipe
	L168 (SMH40948)	Wyoming Sewer	Wyoming St Pelton Street	583.7	595.2	605.8	Crown of Pipe

Member	Meter(s) or Location (Model Junction ID)	Interceptor or Trunk Sewer Name	Cross Streets	Elevation (Feet) (NAVD88)			Criteria for Critical HGL
				Interceptor Invert	Critical	Ground	
	L172 (SMH47489)	Wyoming Sewer	Littlefield Blvd Freda Street	570.9	585.9	602.2	Crown of Pipe
OTHER GLWA REGIONAL CONTROL POINTS							
	Conner RTB Level for Opening Emergency Relief Gates (RTB_ConnerCreek)	DRI and Conner Creek Enclosure	Clairpointe St and Conner Street		578.25	587.15	RTB Operations
	Hubbell-Southfield RTB Crown Elevation of Hubbell-Southfield Outlet Sewer at Inflatable Dam (3601/36011)	Hubbell Sewer and Southfield Sewer	2,000 feet south of Michigan Ave and the American Road	571.79	583.25	599.79	Inflatable Dam Crest
	7 Mile RTB Utility Tunnel Invert Elevation (RTB_7Mile)	9-foot diameter influent sewer	650 feet south of Shiawassee Drive and Verdun Street		614.25	625.25	Prevent Flooding of Utility Tunnel
	Puritan-Fenkell RTB Service Tunnel Invert Elevation (RTB_PF)	12-foot diameter influent sewer	Fenkell St and Riverview Street		608.25	622.89	Prevent Flooding of Service Tunnel
	Oakwood RTB Highest Storm Pump ON Wet Well Level (PS_Oakwood)	Liddesdale Sewer	Liddesdale Street and Sanders Street		557.25	578.87	RTB and PS Operations
	Belle Isle RTB Storm Pump Design Wet Well Level (BelleisleWet Well)	Un-named 4.5-foot sewer	Mroch Dr and Sunset Drive		568.75	578.76	RTB and PS Operations
	Baby Creek SDF Level Upstream of Screens for Opening the Emergency Bypass Gates	Elmer Ternes Sewer	Dix Ave and Amazon St		578.25	584.75	SDF Operations at Normal Detroit River Level (Critical HGL increases to 580.25 when Detroit River is at Detroit Datum)

Member	Meter(s) or Location (Model Junction ID)	Interceptor or Trunk Sewer Name	Cross Streets	Elevation (Feet) (NAVD88)			Criteria for Critical HGL
				Interceptor Invert	Critical	Ground	
	(SDF_BabyCreekInfluent)						El 99.0 at Windmill Point)
	Leib SDF Incoming Crown Elevation of Conant Mt Elliot Sewer (MH49)	Conant-Mt Elliot Sewer	Mt Elliot St and Waterloo Street	573.47	589.72	617.45	Incoming Crown Elevation of the CME Sewer
	St. Aubin SDF Dubois Diversion Chamber Top Elevation of Inflatable Dam (SCH02082)	Un-named 5-foot sewer	Atwater St and Dubois Street	571.25	579.25	581.35	Dubois Diversion Chamber, Inflatable Dam Crest
	Conner Storm PS Wet Well (PS_Conner)	DRI	Jefferson Ave and Conner Street	523.75	558.25	589.25	High design wet well level for storm pumps
	Conner Sanitary PS Wet Well (CON_SanDisChamber)	DRI	Jefferson Ave and Conner Street	525.75	553.75	584.75	Incoming crown elevation of East Jefferson Relief Sewer
	WRRF (WRRF_PS1)	Multiple	Jefferson Ave 2,500 feet NE of Victoria Street	534.25	564.3	575.75	PS1 and PS2 Wet Well NPDES Permit

6.9.4 Analysis of Trunk Sewer, Interceptor and Pump Station Capacity

A collection system model simulation was performed using the 10-year 1-hour storm to determine locations on the regional system where surcharging occurs for 30-minutes or more to 6-feet or less below the ground surface. Results are shown in Figure 6-3 using the Optimized Conditions (OPT) model. These results are consistent with historic data from DWSD and GLWA regarding target areas for continued monitoring of trunk sewer, interceptor and outfall capacity. No immediate capital improvements are proposed for these sewer reaches.

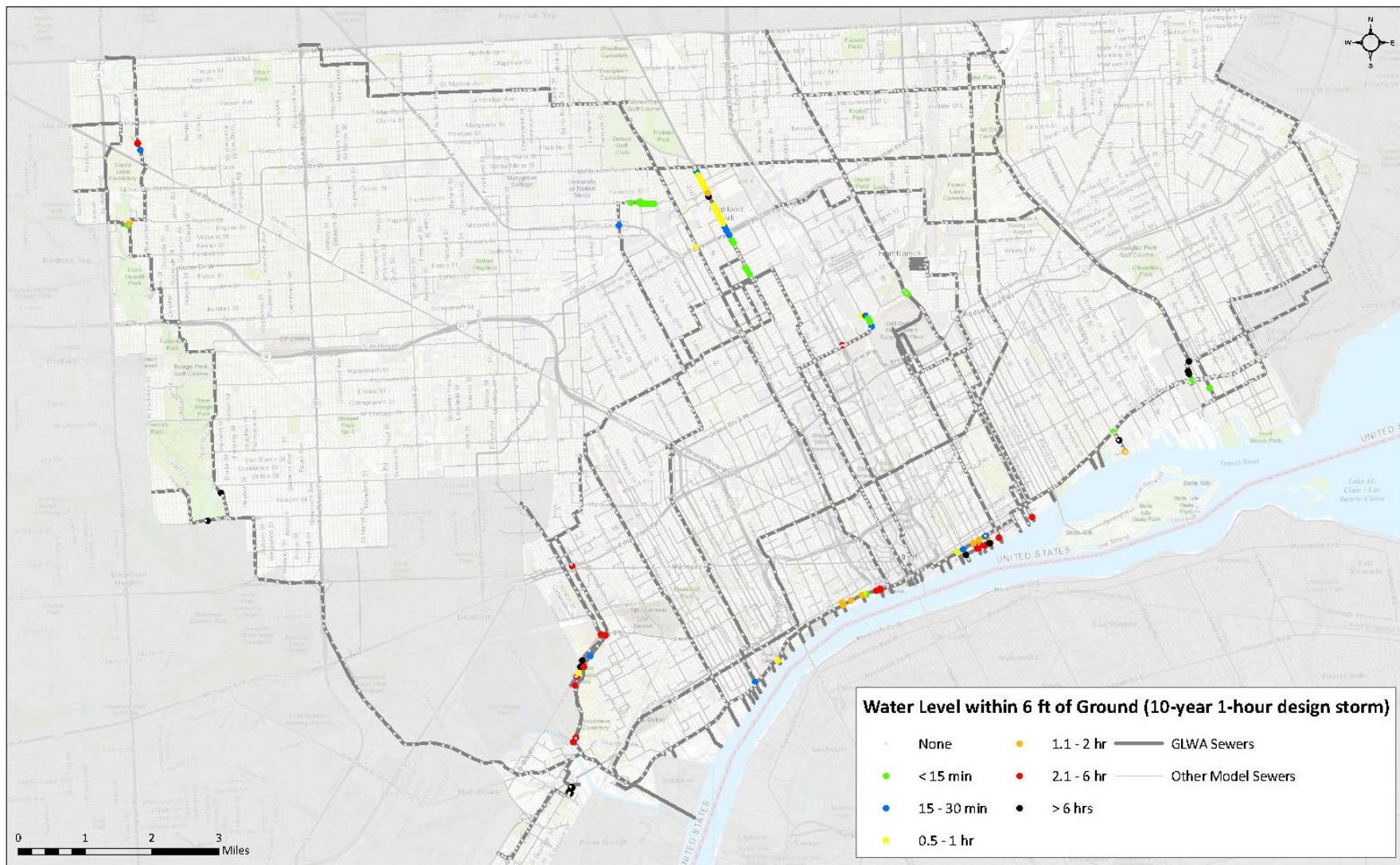

Figure 6-3. Water Level within 6 feet of Ground (10-year 1-hour Design Storm)

Table 6-14 shows modeling results that compare pump station capacity to simulated flows from the 10-year 1-hour and 10-year 24-hour design storm. The table shows pump stations are leased by GLWA as well as those that are owned by DWSD but operated by GLWA.

Table 6-14. Analysis of Pumping Station Capacity for 10-year 1-hour and 10-year 24 hour Design Storms

Pump Station		Capacity (cfs)	10-yr 1-hr storm Peak Influent Flow (cfs)		10-yr 24-hr storm Peak Influent Flow (cfs)	
			No Areal Reduction	Areal Reduction	No Areal Reduction	Areal Reduction
Belle Isle	Sanitary	3.5	100	65	120	110
	Storm	32				
Blue Hill	Sanitary	20	970	770	1,030	1,000
	Storm	1,367				
Conner	Sanitary	350	927	570	1,500	1,450
	Storm	3,500				
Fairview	All	525	460	460	460	460
Freud	Sanitary	80	3,300	2,750	3,450	3,450
	Storm	3,600				
Oakwood	Sanitary	20	700	550	780	750
	Storm	1,660				
Woodmere	All	765	600	500	590	560

All storm pumping stations have capacity for projected 10-year design storm flows.

6.10 Collection System Condition Assessment

GLWA performed a system wide condition assessment of its 183 miles of trunk sewers and interceptors in 2017 and 2018. The Wastewater Master Plan reviewed and geo-coded PACP condition ratings collected by GLWA. Results are summarized on Figure 6-4, and additional detail is presented in Technical Memorandum 6A.

A major design-build project to rehabilitate the Detroit River Interceptor was initiated in 2017, and GLWA is performing a series of other priority rehabilitation projects on segments of trunk sewers and interceptors.

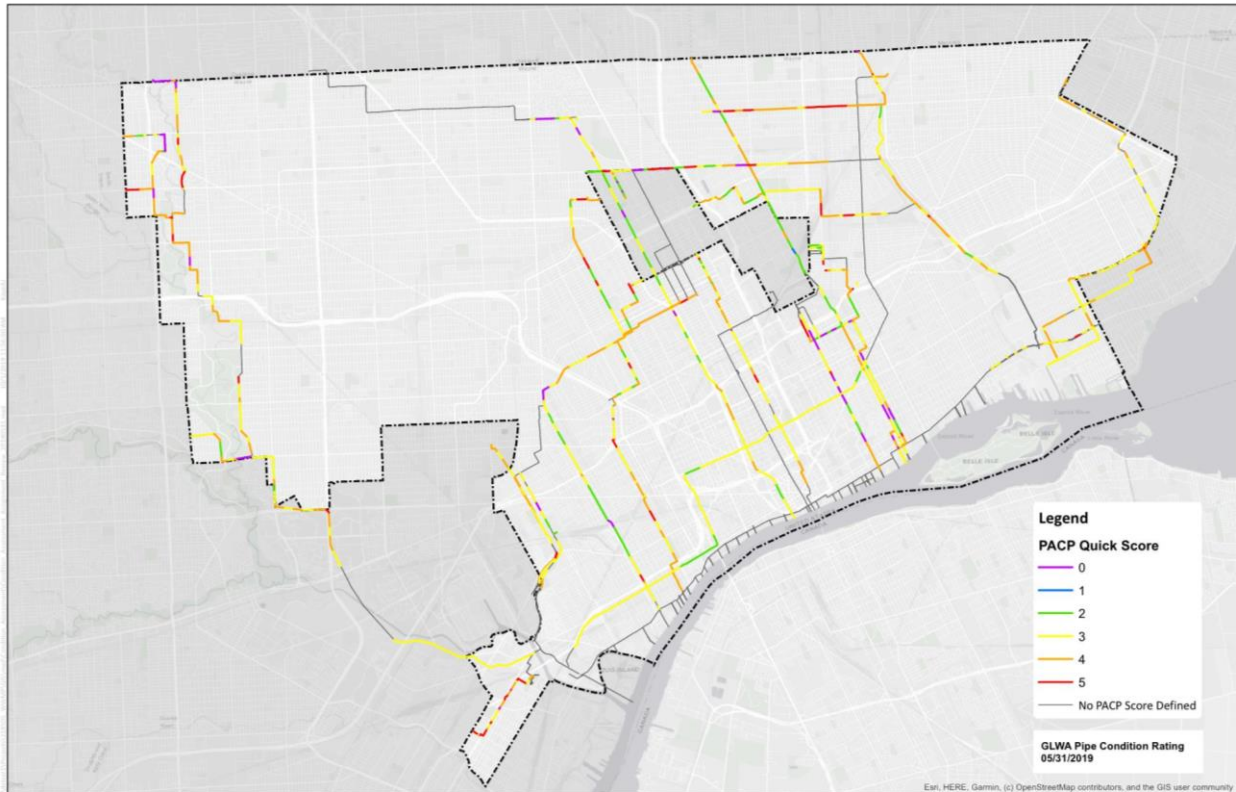

Figure 6-4. GLWA Trunk Sewer and Interceptor PACP Ratings

Technical Memorandum 6A presents discussions of pipeline and outfall condition assessment, river inflow monitoring and control, and pipeline rehabilitation needs over the planning period.

6.11 Collection System Redundancy Assessment

Needs for collection system redundancy were evaluated by the ability to bypass dry weather flow during pipeline rehabilitation projects or during emergency repairs. Each interceptor is discussed below.

Table 6-15. Interceptor Redundancy Requirements

Interceptor Segment	Dry Weather Flow Redundancy Needs
Northwest Interceptor north of Warren Pierson Gate	Dry weather flow can be pumped or diverted to DWSD trunk sewers to bypass rehabilitation or repair reaches. No additional conveyance capacity is needed.
Northwest Interceptor downstream of cross-over of Wayne County Rouge Valley Interceptor	Dry weather flow can be diverted to the Rouge Valley Interceptor for inspection or rehabilitation of the Northwest Interceptor.
Northwest Interceptor between Warren Avenue and cross-over of the Wayne County Rouge Valley Interceptor.	An additional pipeline is needed to convey dry weather flow in this reach.

Interceptor Segment	Dry Weather Flow Redundancy Needs
North Interceptor East Arm (NIEA)	Prior to construction of the NIEA, flows within the City of Detroit were conveyed to the Detroit River Interceptor (DRI). Certain connections to the DRI were bulk-headed, others are gated. Bulk-headed connection at 7-Mile Road can be converted to a gate to allow for diversion of dry weather flow to the DRI.
Detroit River Interceptor	<p>Connections to the NIEA and segments of parallel pipelines are required to bypass dry weather flows for inspection and rehabilitation of the DRI. The NIEA connections and parallel pipes are:</p> <p>Gravity connection to NIEA at West Grand Boulevard (This connection is being evaluated by GLWA).</p> <p>Gravity connection to NIEA at Concord Street.</p> <p>Pumped connection to NIEA at Mack and Gratiot through a new pipeline from new Conner Sanitary Pump Station</p> <p>Parallel pipe along Lafayette east of I-375 with flow direction to the east.</p> <p>Parallel pipe along Lafayette west of I-375 with flow direction to the west.</p>

Figure 6-4 shows conceptual alignments for dry weather flow redundancy. Additional information on the proposed pipelines for dry weather flow redundancy is presented in Technical Memorandum 6A.

Section 7

Water Resource Recovery Facility

7.1 Overview

The Water Resource Recovery Facility (WRRF) is located in southwest Detroit at 9300 W. Jefferson, near the confluence of the Detroit River and Rouge River. Construction of the original interceptors and treatment facility began in 1925 and 1930, respectively, and were completed after a series of construction projects in 1940 to provide preliminary and primary treatment of wastewater conveyed through the Detroit River and Oakwood Interceptors. Wastewater was pumped up to the site through Pump Station No.1, screened, degrittied and received primary treatment in the eight original rectangular clarifiers. Primary effluent was discharged through the Detroit River outfall. Primary sludge generated was dewatered and incinerated. Additional pumping and primary treatment capacity was added in 1956. With the advent of the Clean Water Act the activated sludge process was added with four aeration decks, (3 of the 4 using high purity oxygen generated on-site and one using air), and a total of 25 secondary clarifiers constructed between 1970 and 1982. Sludge thickening Complex B and Incinerator Complex II was also constructed at this time to manage the waste activated sludge production. In 1988, construction of Pump Station No. 2 and associated preliminary treatment commenced to convey and treat flow from the Northeast Interceptor-East Arm (NIEA) (and the Oakwood interceptor under high flows) to the WRRF. Pump Station No. 2 went on-line in 1996. Additional circular primary clarifiers were constructed in 1971, 1980 and 2005. The most recently completed major construction projects, adding new treatment infrastructure, were the biosolids drying facility which became fully operational in 2016 and the Rouge River outfall project, providing chlorination and dechlorination to primary effluent discharged during wet weather, which went on-line in the Spring of 2019. Figure 7-1 presents the historic build-out of the existing WRRF, the history of major WRRF Improvement projects is presented in Table 7-1 and the liquid and solid stream flow schematics are presented in Figure 7-2 and 7-3.

7.2 Basic Planning Criteria

7.2.1 Flows and Loads

Currently, (2018) the WRRF serves approximately 2.7 million residents in southeast Michigan through a combination of separate and combined sewers. Over the period FY2015 to FY2017, the WRRF treated approximately 630 million gallons per day (MGD) of wastewater. The permitted peak primary treatment capacity is 1,700 mgd (the largest in the nation) and the peak secondary treatment capacity is 930 mgd. Flow in excess of the peak secondary treatment facility capacity bypasses secondary treatment and is discharged through the Detroit River outfall (049). Flow in excess of the Detroit River Outfall capacity is directed to the Rouge River outfall (050). The capacity of the Detroit River and Rouge River Outfalls is a function of the water surface elevation in the rivers which can be compromised if river elevations exceed 98 ft (Detroit City Datum). During the summer of 2019 Detroit River elevations approached historic maximum levels.

Based on the projected population increase in the service area, presented in Section 5, the resulting added sanitary flow is estimated at 10.1 mgd by 2045 and 16.6 mgd by 2060, a relatively small fraction of the total plant flow. Flow projections will likely be more influenced by other outside influences including water conservation, shifts in service population to or from other outside wastewater treatment plant providers, significant growth or shifts in industrial users, and removal of I/I in the collection system. Flow and load projections for 2045 and 2060 are presented in Tables 7-2 and 7-3. Details regarding the development of future flows and loads are presented in Technical Memorandum 5A.



Figure 7-1. Historic Build-out of Existing WRRF

Table 7-1. History of Major Improvements at the WRRF

Interceptor, Pumping or Process Area	Time Period	Contract Number	Description of Construction or Upgrade
Detroit River Interceptor	1925 to 1940		Construction of DRI
Oakwood Connecting Sewer	1939	OI-2	The contract also installed 36" reinforced concrete pipe and an under-river tunnel with two shafts to connect the area south of the Rouge River to the Oakwood interceptor and ultimately to the influent pump station.
Pump Station 1	1940		Construction of PS1
Pump Station 1	1956		Two additional pumps added
Pump Station 2 and NIEA	1988 to 1996	PC-655	Pump Station 2 connected the previously complete NIEA to the WRRF
Pump Station 2	2000 to 2004		Added another influent pump
Rectangular Primary Clarifiers	1927		Installed original clarifier Units 1 to 8
Rectangular Primary Clarifiers	1956		Installed clarifier Units 9 and 10
Rectangular Primary Clarifiers	1970		Installed clarifier Units 11 and 12
Rectangular Primary Clarifiers	1991 to 1995		Replace main longitudinal collectors and cross collectors, repaired concrete inside the tanks for all units
Rectangular Primary Clarifiers	2001 to 2005		Replace troughs and weirs with 316SS
Rectangular Primary Clarifiers	2016		Crack repair, replace longitudinal and cross collectors with drive mechanisms.
Circular Primary Clarifiers	1971		Construct Units #13 and 14
Circular Primary Clarifiers	1980		Construct Units #15 and 16
Circular Primary Clarifiers	2005		Construct Units # 17 and 18
Circular Primary Clarifiers	2014	PC-756	Rehab of clarifiers 13-16 involved replacement of internals (mechanism, scum deflector, skimmer arm, effluent trough)
Activated Sludge Process	1970	PC-1970	Construct Intermediate Lift Station
Activated Sludge Process	2003	PC-751	Intermediate Lift Station Replace Pumps 1 and 2
Activated Sludge Process	Early 1990s	CM-640	Install Intermediate Lift Pumps 3, 4, and 7
Activated Sludge Process	1970	PC-233	Installation of Aeration Tanks 1 and 2. Aeration tank 1 originally designed as air activated sludge tank with coarse bubble diffusers, aeration tank 2 oxygen activated sludge with mechanical splash aerators. Included design for future conversion
Activated Sludge Process	2003	PC-744	Aeration tank 1 converted to oxygen
Activated Sludge Process	1974	PC-283	Install aeration tank #3 and 4 as oxygen reactors
Activated Sludge Process	2005	DWP-1054	Switch from on-site generation of HPO to Praxair HPO supply

Interceptor, Pumping or Process Area	Time Period	Contract Number	Description of Construction or Upgrade
Activated Sludge Process	1972 to 1982		Secondary clarifiers constructed
Activated Sludge Process	2000 to 2005	PC-720	Rehabilitation included replacement of center drives, new flowmeters, replace weirs and troughs, sludge blanket detectors.
Detroit River Outfall	1938		Original outfall construction
Detroit River Outfall	2003		Chlorination upgrade and de-chlorination added
Rouge River Outfall	2017 to 2019	PC-797	Disinfection/dechlorination upgrades to disinfection primary effluent
Sludge Thickening	1972	PC-241	Complex A constructed
Sludge Thickening	1976	PC-294	Complex B constructed
Sludge Thickening	2006		Complex A and B rehabilitated
Sludge Dewatering	1940		Complex I vacuum filters installed
Sludge Dewatering	1992	PC-616	Complex I belt filter presses installed
Sludge Dewatering	2000		Complex II Lower Level Centrifuges: Installed 8 Units
Sludge Dewatering	2000	PC-691	Complex II Upper Level Belt Filter Presses: Installed 12 Units
Sludge Dewatering	2014 to 2017	PC-787	Complex I and II Belt Filter Presses: Replaced 20 Units
Biosolids Drying	2015	PC-792	New BDF collects liquid sludge from blend tanks then dewateres with centrifuges, and dry in rotary drum dryers prior to haul agricultural land application
Incineration	1940		Installed Complex I
Incineration	1970		Installed Complex II
Incineration	2013	PC-791	Air quality improvements including new quench water system, wet scrubber, and venturi scrubber.
Incineration	2013 to 2016		Decommissioning of Complex I incinerators
Process Control Center	2004	PC-744	Development of plant schematics and P&IDs

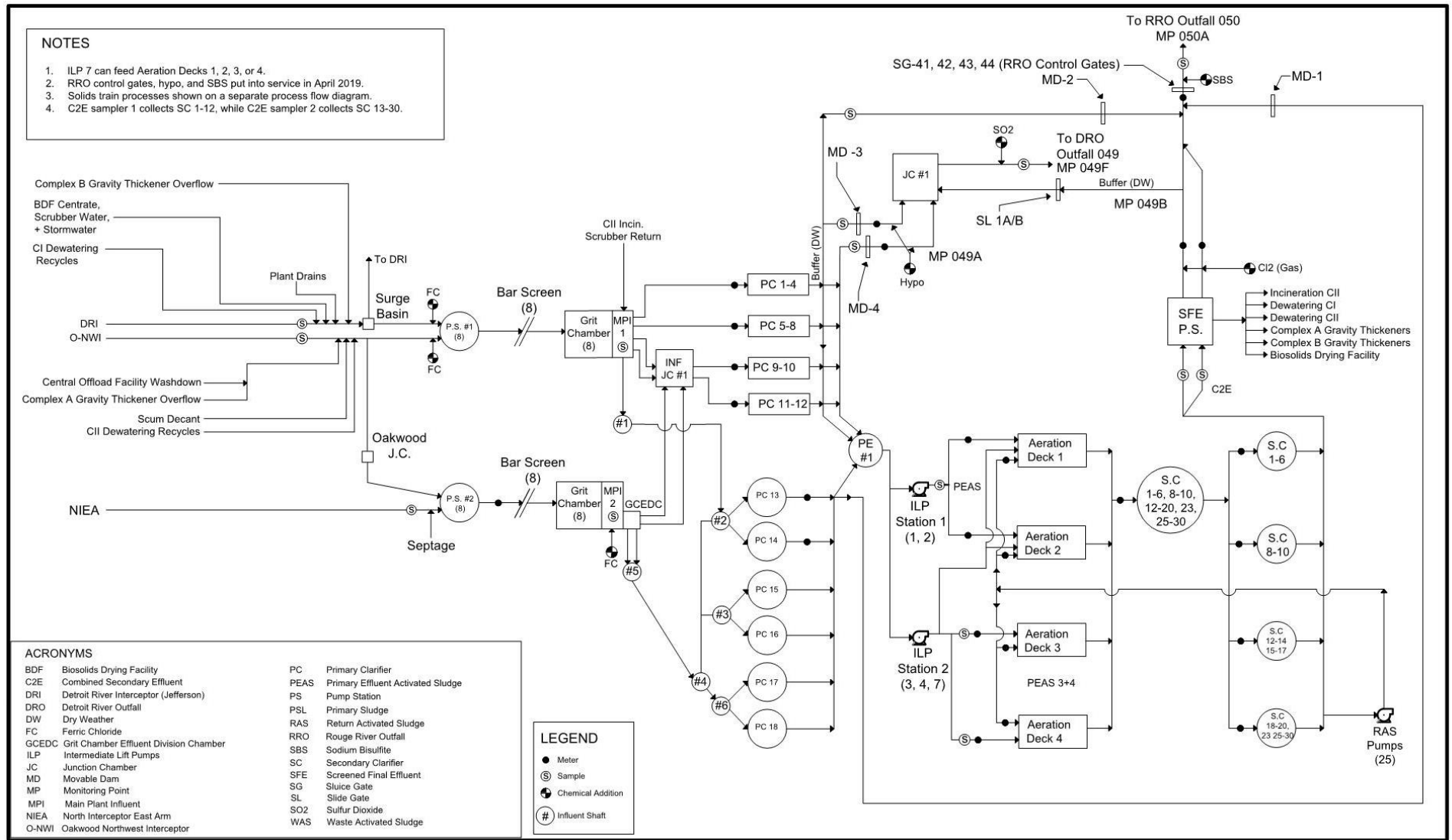

Figure 7-2. Existing Liquid Train Process Flow Diagram

© 2012 CDM SMITH ALL RIGHTS RESERVED. REUSE OF DOCUMENTS, THESE DOCUMENTS AND DESIGNS PROVIDED BY PROFESSIONAL SERVICE, INCORPORATED HEREIN, ARE THE PROPERTY OF CDM SMITH AND ARE NOT TO BE USED, IN WHOLE OR PART, FOR ANY OTHER PROJECT WITHOUT THE WRITTEN AUTHORIZATION OF CDM SMITH.

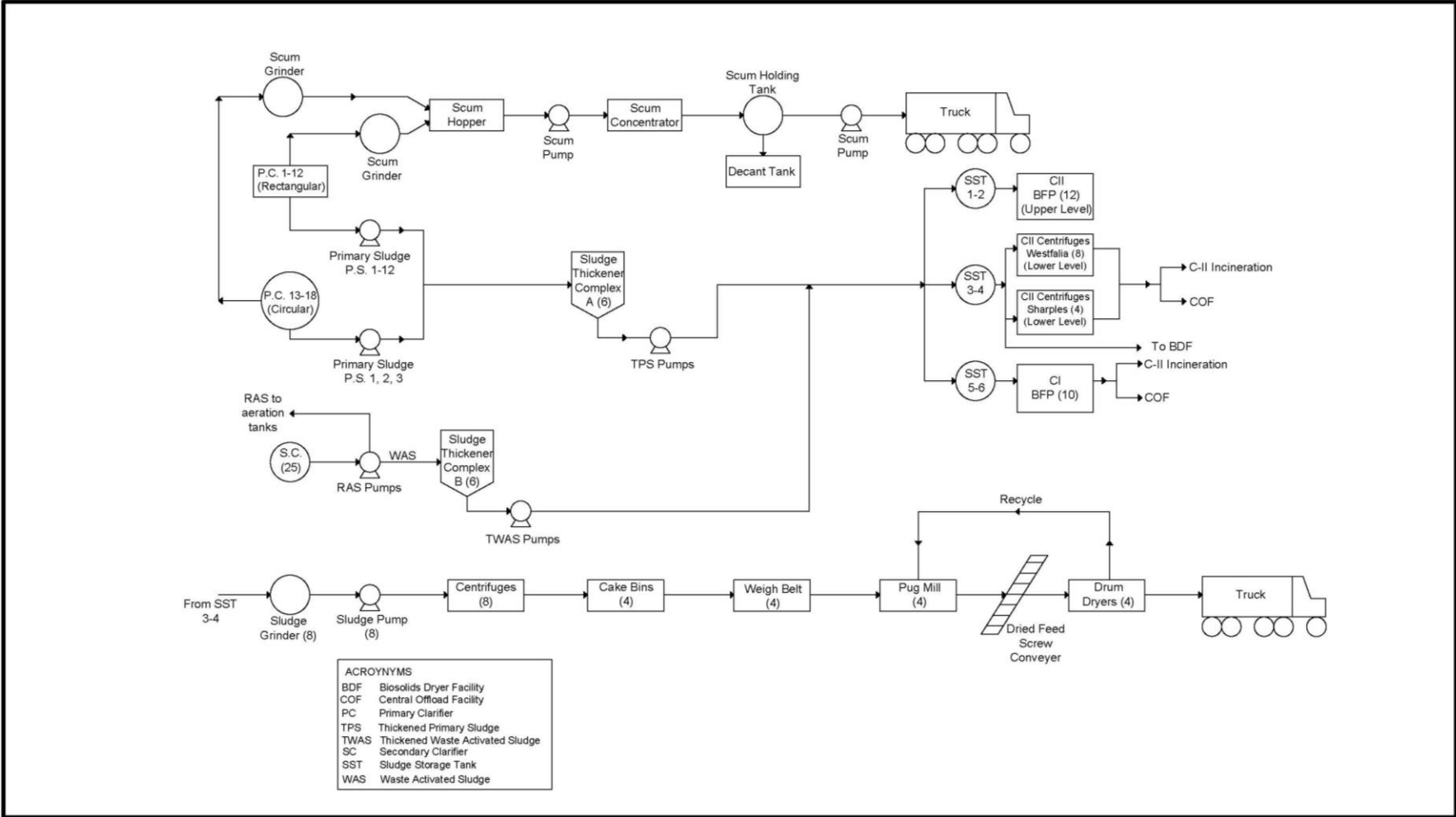

Figure 7-3. Existing Solids Train Process Flow Diagram

To be conservative, infiltration has been assumed to remain constant over time, while inflow has been projected to increase based on the capture of currently untreated CSOs. It is assumed that any reduction in infiltration will likely result in a commensurate increase in inflow captured, so it is likely that maximum day and peak flows may not shift significantly from current projection. The flow estimates that may be most influenced by the reduction in infiltration is average day and minimum flows. To ensure that new pumps and unit processes are designed to operate efficiently at average flows and can be turned down to operate at minimum flows, it is recommended that flows and loads be continuously monitored and updated every 5 years to reflect the current trends in the system and more accurate flow measurement when new meters are installed.

Table 7-2. Projected Influent Flow

Parameter	Existing Flow (mgd)	2045 Flow (mgd)	2060 Flow (mgd)
Average Daily Flow	630	651 to 662	668 to 679
Maximum Day Flow	1,257 ¹	1,299 to 1,321	1,333 to 1355
Peak Hour Flow	1,902 ²	1,700	1,700
Minimum Day Flow	389	376 to 400	380 to 404

¹The existing maximum daily flow represents the 98th percentile of flow from the historical 3-year dataset.

²The peak hour flow recorded from the historical 3-year dataset exceeded the primary treatment capacity of 1,700 mgd.

Table 7-3. Average Existing and Projected Raw¹ Influent Load

Constituent	Existing (ppd)	(mg/L) ²	Projected 2045 (ppd)	(mg/L) ²	Projected 2060 (ppd)	(mg/L) ²
BOD	581,000	111	616,000	112	641,000	113
TSS	744,000	142	788,000	143	820,000	145
VSS	554,000	105	586,000	106	610,000	108
Ammonium-N	63,100	12	*	*	*	*
TP	13,300	2.5	14,500	2.6	15,300	2.7

¹ – Does not include plant recycles

² – Concentrations based on higher flow projection

* with no existing or anticipated ammonium permit limit, future influent ammonium was not projected

Future sidestream loads will not only increase with increasing influent loads but could also increase based upon the ultimate solids handling recommendations that are pursued, and whether or not GLWA chooses to accept outside waste (including sludge from surrounding treatment facilities, organic waste or other high strength industrial waste). Future sidestream loads will be developed and analyzed through BioWin modeling.

7.2.2 Permit Limits

GLWA and the Detroit Water and Sewer Commission are regulated by the National Pollutant Discharge Elimination System (NPDES) Permit No. MI0022802 issued by the State of Michigan Department of Environment, Great Lakes & Energy (EGLE). The permit authorizes discharge of

effluent from the WRRF to the Detroit River and the Rouge River and from combined sewer overflow facilities to the Detroit River, the Rouge River and Conner Creek. The current permit took effect on September 1, 2018 and expires on October 1, 2022. The Detroit River Outfall (DRO) – Outfall 049 – is the primary outfall of the WRRF. The Rouge River Outfall (RRO) – Outfall 050 – is the secondary outfall that may be used if the DRO is out of service for repairs, or if the capacity of the DRO is exceeded.

The permit limits for the four on-site monitoring points that went into effect after the initiation of the RRO Disinfection Project on April 1, 2019 are summarized in Table 7-4. The location of each monitoring point is shown schematically on Figure 7-4. Monitoring point 049A represents primary effluent, monitoring point 049B represents the secondary effluent, monitoring point 049F represents the DRO discharge, and monitoring point 050A represents the RRO discharge.

Table 7-4. Summary of NPDES Permit Limits

Monitoring Location	049A Primary Effluent	049B Secondary Effluent	049F DRO Discharge	050A RRO Discharge
Parameter				
Flow (mgd)	Report	Report	Report	Report
CBOD ₅ (mg/L)	40	25	Report	---
TSS (mg/L)	70	30	---	---
Total Phosphorus (mg/L)				
April – Sept	1.5	0.6	---	---
Oct – Mar	1.5	0.7	---	---
Ammonia Nitrogen (mg/L)	Report	Report	Report	---
Total Mercury (lb/d) ⁽¹⁾	0.19	0.023	---	---
pH	---	6.0 to 9.0	6.0 to 9.0	6.0 to 9.0
fecal coliform (cts/100ml)	---	---	200	200
total residual chlorine (ug/L) ⁽²⁾	---	---	0.11	0.038
oil & grease (mg/L) ⁽³⁾	---	---	15	15
Minimum Dissolved Oxygen (mg/L)	---	---	Report	3.0
PCBs (ug/L)	---	---	<0.1	<0.1
Available Cyanide (ug/L) ⁽²⁾	---	---	Report	44
Total Copper (ug/L)	---	---	Report	---

(1) 12-month rolling average

(2) Daily Limit

(3) 7-day limit

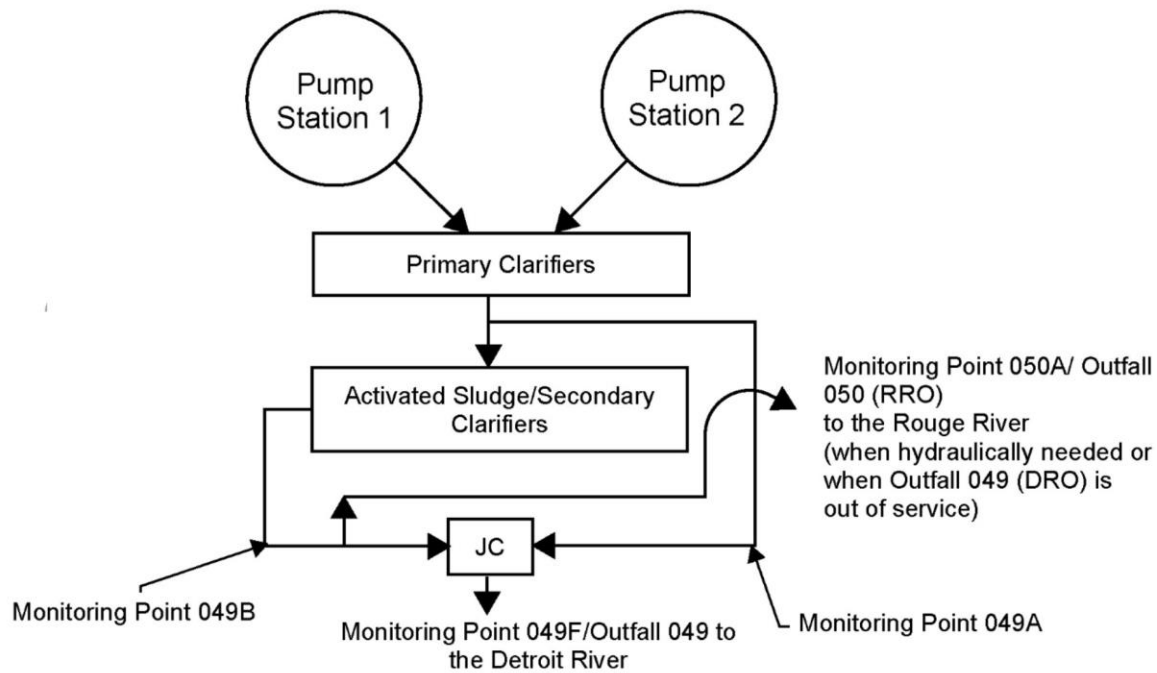

Figure 7-4. Four Monitoring Points for Final Effluent at the WRRF

Review of recent data (2014 to 2017) shows the plant does a nice job achieving effluent quality standards with secondary effluent concentrations for cBOD, TSS and total phosphorus (TP) averaging 5.8 mg/L, 9.0 mg/L and 0.39 mg/L, respectively. In terms of loading, the metric tonnes discharged annually, including discharge from 049A average approximately 5,800, 9,100 and 350 for cBOD, TSS and TP, respectively.

It is not expected that permit limits will be modified dramatically in the next permit cycle or two. However, the desire to better manage high flows through secondary treatment and/or to achieve better primary effluent quality during wet weather could be expected. Further, national trends regarding control of nutrients may ultimately result in more stringent effluent TP limits. It is assumed that the WRRF will not receive a permit limit for nitrogen within the planning period, and therefore the need for nitrogen removal has not been considered during the planning process.

Researchers at the University of Michigan have been studying the TP load into and out of the Lake St. Clair and Detroit River system (Scavia et. al., 2018, 2019) and have acknowledged the significant reduction in TP from the GLWA WRRF over the last two decades, yet most recent data indicates additional reduction may be necessary to meet the targeted international agreement between the US and Canada.

7.2.3 System Models

To assist in the evaluation of treatment alternatives two system models were developed and described in more detail in Technical Memoranda 3 and 5A. A biological process model for liquids

and solids unit process was developed and calibrated to provide a tool that can be used for evaluating how variations in flow and loading affect the existing treatment processes, and to support alternatives analyses and eventually design of the recommended improvements. Numerical models describe observed chemical, physical, and biological reactions to help characterize the expected behavior of wastewater treatment processes that are intricately related. For this project, the BioWin modeling software (Version 5.3.0 1208, EnviroSim Associates, Ltd.) was used.

In addition, a full-plant hydraulic model was developed and clarifier stress testing and modeling performed to document baseline operating conditions, assess the plant’s current hydraulic capacity, and identify hydraulic bottlenecks that may impact treatment or energy consumption. The results of the modeling and testing has been used to guide optimize operating practices, assist in the Master Planning process and inform the capital improvement program.

7.3 Desired Outcomes and Performance Measures for WRRF

As noted, the planning period for this Wastewater Master Plan is 40 years (2020 – 2060). With respect to the WRRF, its purpose is to assess the broad needs of the facility and the level of service provided to its members and continue to improve the receiving water quality through the year 2060. Understanding that there are numerous capital improvement projects recently completed, ongoing, and planned, the intent of this Master Plan is to help GLWA invest wisely and move towards a scheme to “build-it-best” rather than “replace-in-kind” and with each project advance the Utility of the Future goals. GLWA’s Capital Improvement Plan (2020 – 2024) identifies the investment needs in the near-term. These projects have been assessed and recommendations made herein to modify the plan to dovetail with the Master Planning concepts to avoid sunk costs and missed opportunities.

The scale and scope of the Water Resource Recovery Facility presents challenges in maintenance, rehabilitation, and replacement. Capital projects across the plant must be implemented while facilities are on-line, posing operational challenges. Decisions to replace aging assets with more efficient, up-to-date treatment processes must be appropriately vetted, and also phased to ensure continued operation of the facility. The facility must move forward in a logical fashion, ensuring integration with ongoing programs, and strive towards a culture of Effective Utility Management to further the Utility of the Future concepts, where precious resources are recovered in a sustainable fashion, while the following desired Master Plan outcomes are achieved:

- Protect public health and safety
- Preserve (and restore) natural resources and a healthy environment
- Maintain reliable, high quality service
- Assure value of investment
- Contribute to economic prosperity

Desired outcomes and performance measures related to the WRRF are presented in Table 7-5.

Table 7-5. Desired Outcome and Performance Measures for WRRF

Desired Outcome	Performance Measures
Protect Public Health and Safety	Frequency of Primary Effluent Discharges when average daily flow is less than 930 mgd
	Volume of Primary Effluent Discharges when average daily flow is less than 930 mgd
	Annual number of Primary Effluent Discharges (dependent, in part, on climate)
	Annual Volume of Primary Effluent Discharges (dependent, in part, on climate)
	Number of fecal coliform violations annually
	Number of air quality violations annually
	Number of odor complaints annually
	Tons of gaseous chlorine used annually
Preserve (and Restore) Natural Resources and a Healthy Environment	kWh/MG treated
	KWh/lb BOD removed
	Volume of Chemicals used annually
	Natural Gas used annually
	MG potable water used annually
	Volume of Oxygen used annually
	Pounds of Phosphorus discharged annually
	Pounds of BOD discharged annually
	Pounds of TSS discharged annually
	Number of TRC violations annually
	Renewable energy projects implemented on-site
	Green infrastructure implemented around site
Maintain Reliable, High Quality Service	Influent Pumps out of service for long-term maintenance
	Screens out of service for long-term maintenance
	Grit Tanks out of service for long-term maintenance
	Primary Clarifiers out of service for long-term service
	Aeration Decks out of service for long-term maintenance
	Secondary Clarifiers out of service for long-term maintenance
	Chlorinators out of service for long-term maintenance
	Sulfunators out of service for long-term maintenance
	Number of Permit Violations Annually
	Tons of Screenings removed annually
	Tons of Grit removed annually

Desired Outcome	Performance Measures
Assure Value of Investment	Unit cost per MG of wastewater treated
	Chemical use/MG treated
	Oxygen use/MG treated
	kWh/MG treated
	Annual Cost for Emergency Repairs
	Annual Cost for Asset Management
Contribute to Economic Prosperity	Staff employed by WRRF
	Number of local Industries supporting facility operations (e.g. Praxair, NEFCO, sodium hypochlorite generator)
	Improved industrial cooperation (e.g. acceptance of high strength waste for treatment process)

The desire of GLWA management to efficiently and effectively treat wastewater, increase the resiliency of the system and assure the value of investment in the facility is central to the evaluations presented herein. Although this section is broken down by unit process, we acknowledge and have taken a holistic view of the treatment facility and understand how decisions made in one unit process can impact the performance and/or sizing of another process. This interplay includes managing carbon throughout the system, understanding the implications of chemical addition, and accounting for high strength sidestreams that are a function of the selected residuals management systems. For each section, a brief description of the existing facilities is provided, as well as a brief description of recent, ongoing and proposed CIP projects. A summary of the screening evaluation of alternatives for treatment are presented herein as well as the development of the most feasible alternatives. More detailed information related to the evaluation of liquid and solids treatment trains is included in Technical Memoranda 5A and 5B.

7.4 Influent Pumping and Preliminary Treatment

7.4.1 Introduction

Influent pumping and preliminary treatment include an assessment of Pump Stations Nos. 1 and 2 and associated screening and grit removal. The importance of an effective, resilient and reliable pump station and headworks cannot be understated. Pump station reliability maximizes the flow that can be accepted at the treatment facility to receive primary and secondary treatment prior to discharge, and thus minimize CSOs in the collection system to preserve and restore natural resources and a healthy environment and maintain public health and safety. Effective grit and screening removal can dramatically impact the performance and reliability of downstream unit processes and assures the value of investment in the equipment. The cost of ineffective grit and screenings removal is difficult to quantify but has been shown to manifest in excessive buildup of grit in downstream channels making gates difficult or impossible to operate and reducing conveyance capacities; excessive wear and shortened life of primary sludge pumps, sludge collection equipment and downstream solids processing equipment; clogging of basket strainers on RAS pumps, and reduced quality of the biosolids product.

From a holistic Master Planning stand point the following challenges are addressed in this section:

- the need for and feasibility of increased pumping capacity and pumping reliability
- the need for improved screenings removal and screenings handling
- the need for improved grit removal and grit handling

7.4.2 Existing Conditions

Pump Station No. 1 (PS1) and associated screening and grit infrastructure date back to the construction of the original treatment facility completed in 1940. Although most of the equipment has been refurbished over time, most of the structural and architectural elements are original and approaching 80 years of age. Pump Station No. 2 (PS2) and associated screening and grit infrastructure were designed in the late 1980s and put into operation in the mid-1990s and so are 25 years old.

7.4.2.1 Pump Station No. 1 and Associated Headworks

Wastewater influent from the collection system flows to PS1 through the Detroit River Interceptor (DRI) and the Oakwood Interceptor. The majority of the sidestream flows are also directed to PS1. Raw wastewater enters a small divided wet well with four pumps per side. PS1 is equipped with eight vertically-mounted, end suction, constant speed, solids handling pumps of varying capacity. The current total firm capacity of PS1 is 1,129 mgd, about 100 mgd less than the design firm capacity of 1,225 mgd since the aging pumps can no longer achieve the design capacity at the design point head. Firm capacity is defined as the total capacity with the largest unit out of service. The installed *design* capacity of PS1 is 1,330 mgd.

Each pump has a dedicated discharge channel, followed by a dedicated $\frac{3}{4}$ " catenary bar screen and a constant velocity grit chamber. Screenings are conveyed via a belt conveyor to a dumpster for landfill disposal. No washing or compaction is provided for the screenings. There are eight area velocity grit chambers, each with a north and south chain and bucket system to remove grit. Grit removed from the chamber is transferred to separate conveyor belts, then to a dumpster for landfill disposal. Since the screenings and grit channels in PS1 are dedicated to an individual pump, the reliability of the system is dependent on the entire train of equipment being functional. If any one piece of equipment is off-line the entire train must be shut down. There is no flow metering at this station. Flow through this station is estimated by pump curves and includes recycle flows. A flow schematic of PS1 and its associated headworks is presented in Figure 7-5.

Under average dry weather flow conditions, flow from the DRI and Oakwood Interceptor are pumped through PS1 using 2 or 3 of the 8 pumps. Under peak flow conditions, pump stations operate with all available pump, screen, and grit trains. Wet wells in the two pumping stations (PS1 and PS2) equilibrate through the interconnection via the Oakwood Interceptor under high flows.

Flow from PS1 can go to one of five possible locations through existing conduits as presented on Figure 7-6:

- Rectangular Primary clarifiers (PC) 1-4
- Rectangular PC 5-8
- Rectangular PC 9-10 via INF JC #1

- Rectangular PC 11-12 via INF JC #1
- Influent shaft 1 with subsequent flow to Circular PC 13-16

Flow to each group of clarifiers were designed to be isolated with dedicated slide gates and individual clarifiers can be taken out of service with gate valves. Today isolation of rectangular clarifiers 1-8 can only be accomplished by shutting the gates to the individual tanks.

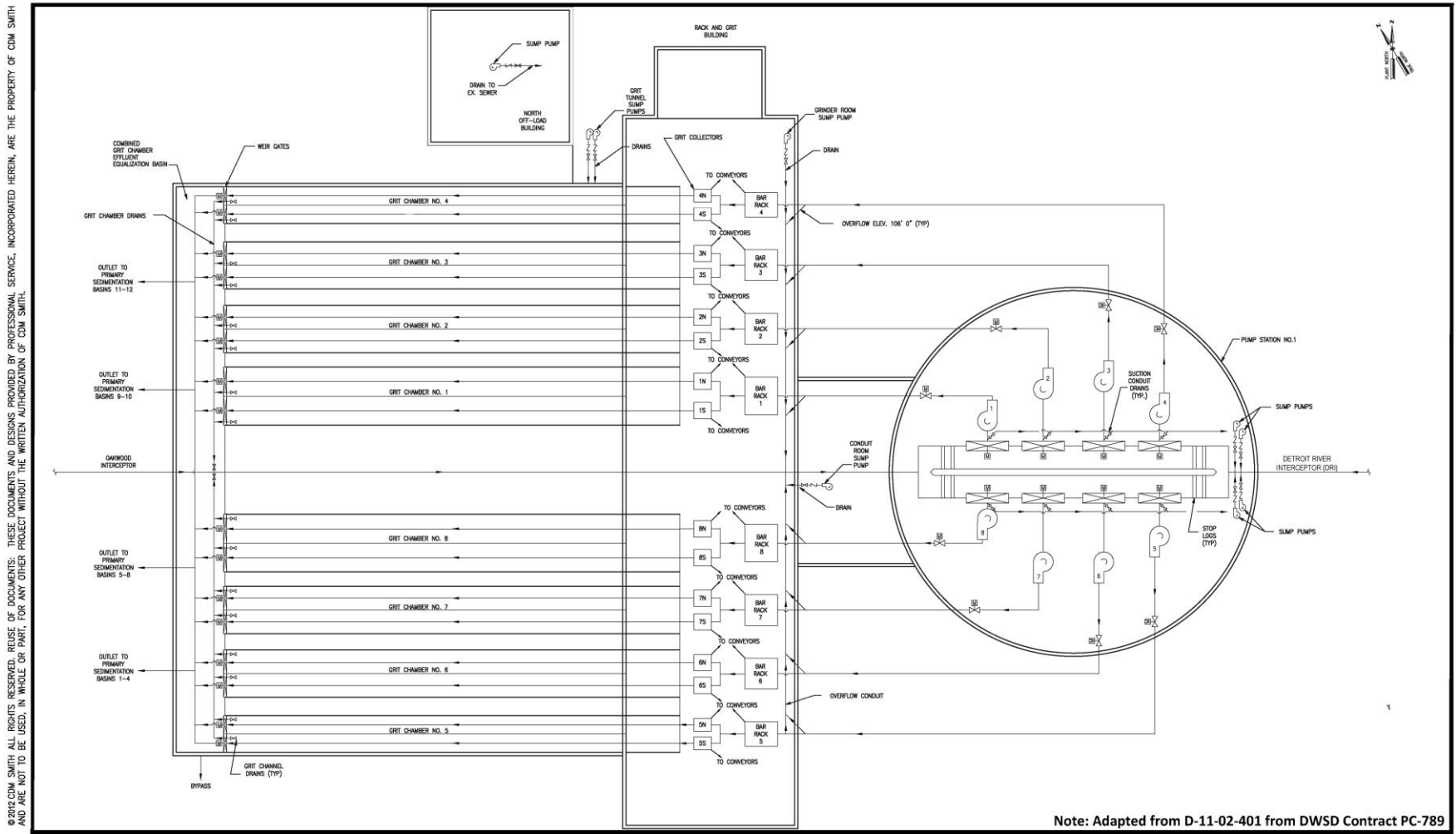

Figure 7-5. Flow Schematic of PS1 and Its Associated Headworks

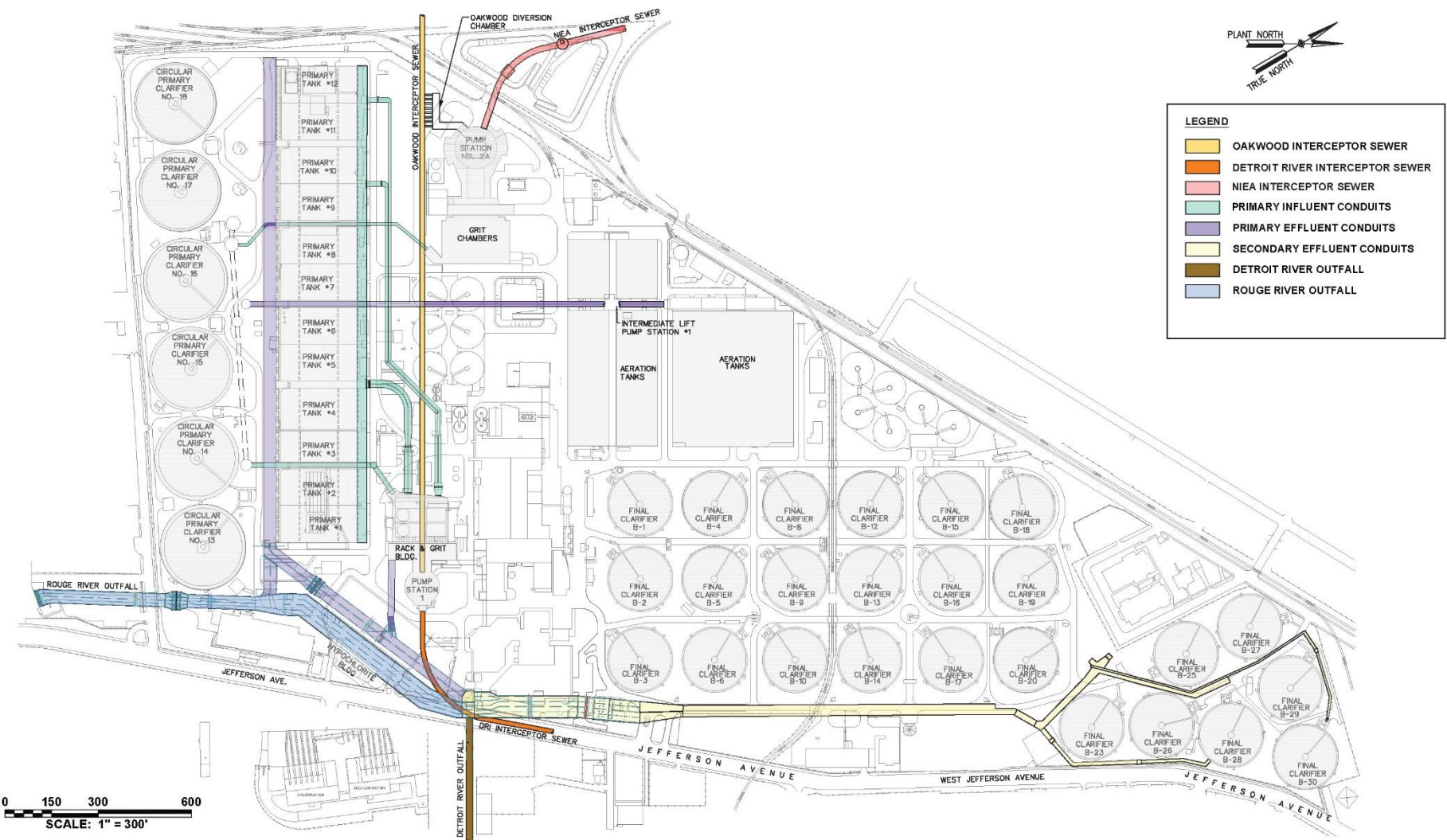

Figure 7-6. Influent Sewers and Major Inter-process Conveyance

7.4.2.2 Pump Station No. 2 and Associated Headworks

PS2 receives flow from the North Interceptor East Arm (NIEA) and during wet weather from the Oakwood Interceptor. When the wet well levels at Oakwood Interceptor exceed approximately 74-ft, flow from Oakwood is conveyed through the Oakwood Junction Chamber to PS-2. Note this connection pulls from the spring line resulting in flow conveyed from the upper half of the Oakwood interceptor thus likely may not contain as much of the heavy solids (e.g. grit) but may contain more floatables. NIEA is a separated sewer system and tends to be higher strength than flow from the combined Oakwood Interceptor. Flow enters two wet wells interconnected by a sluice gate. Currently, this gate is normally open, however, a recent recommendation from the energy audit recommended closing this gate to reduce the static head on the pumps and thus reduce pumping costs. We concur with this recommendation. There is also a passive interconnection between the two wet wells in PS2 that activates when the level exceeds 90 ft. A provision to connect the not-yet-constructed West Side Relief Interceptor to PS2 was included in the original design, but this connection has not yet been designed.

PS2 is equipped with eight mixed-flow, vertically mounted, end suction, solids handling pumps each with a design capacity of 115 mgd during wet weather conditions, for a firm design capacity of 805 mgd. Overtime, the capacity of these pumps has diminished with a current estimated capacity closer to 89 mgd each, reducing the firm capacity of the PS2 to 623 mgd. The design installed capacity is 920 mgd. Under average conditions flow from the NEIA is pumped using 2 or 3 of the 8 pumps. Magnetic flow meters on the discharge of each pump provide total flow measurement from PS2.

The wastewater is pumped from each side of the wet well into two separate discharge channels, which combine into a common aerated influent channel. This influent channel feeds eight bar screen channels. The screened wastewater then flows into another common aerated channel which feeds eight grit chambers. Screened and dewatered wastewater leaves the PS2 grit chambers in a third common aerated channel. Unlike PS1, the screening channels and grit chambers in PS2 can be individually taken out of service, and the flow can be diverted into the remaining online units increasing the reliability and redundancy of this station. The number of bar screens and grit chambers are independent of the number of pumps in service at PS2. Typically, one more screen channel is in service than the number of operational pumps to better manage increases in influent flow. Preliminary CFD modeling of the influent channels suggests that this operational strategy could promote grit deposition in the channels ahead of the grit tanks. Figure 7-7 presents a schematic of PS2 and its associated headworks.

© 2012 CDM SMITH ALL RIGHTS RESERVED. REUSE OF DOCUMENTS, THESE DOCUMENTS AND DESIGNS PROVIDED BY PROFESSIONAL SERVICE, INCORPORATED HEREIN, ARE THE PROPERTY OF CDM SMITH AND ARE NOT TO BE USED, IN WHOLE OR PART, FOR ANY OTHER PROJECT WITHOUT THE WRITTEN AUTHORIZATION OF CDM SMITH.

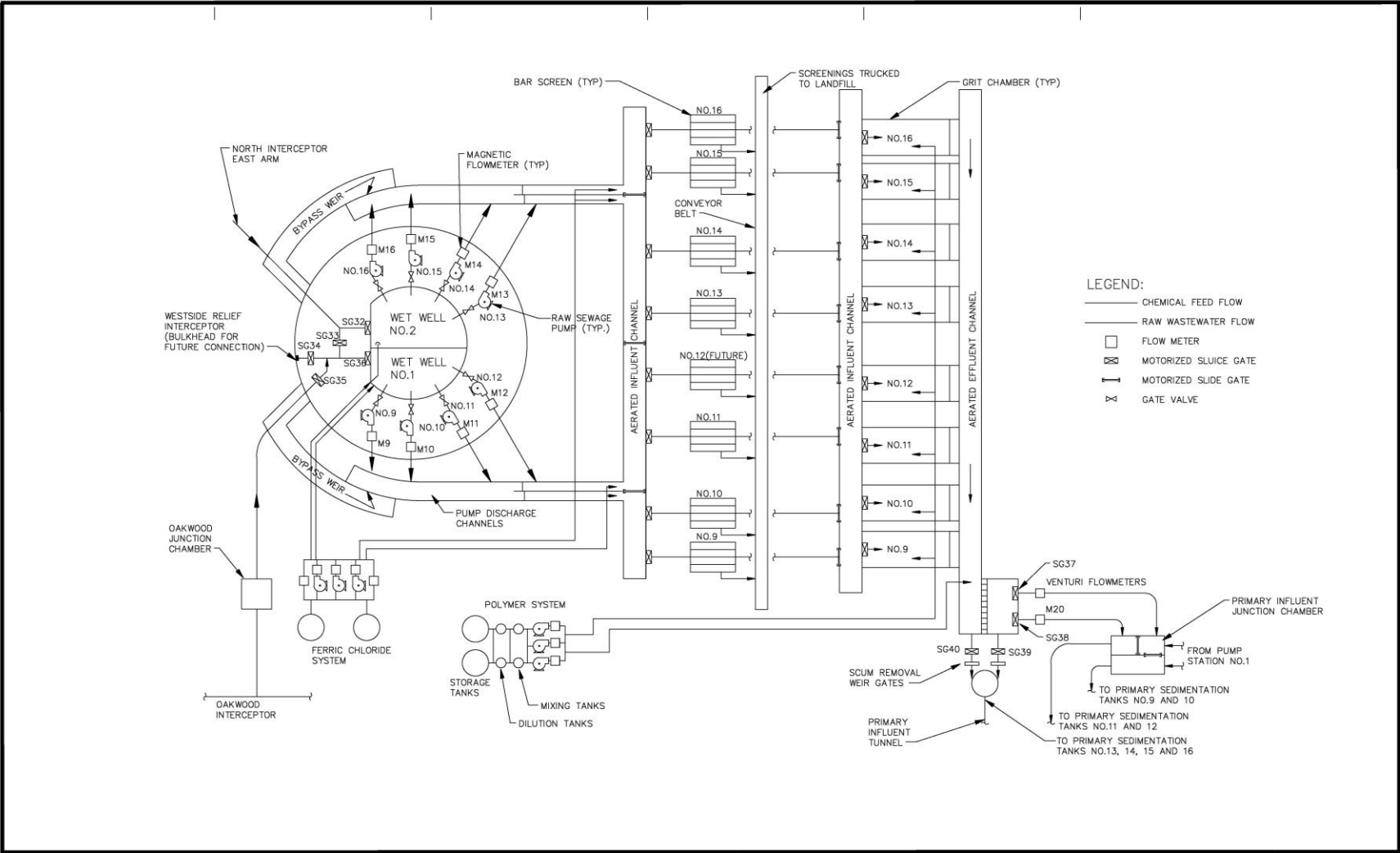

Figure 7-7. Schematic of PS2 and Its Associated Headworks

Periodically the grit tanks are drained and grit is removed with a clamshell. There are 3 multi-stage centrifugal blowers (4,000 scfm each) used for aerated grit and to prevent solids deposition in the channels (screen influent, grit influent, grit effluent channels). Typically, one blower is in operational. The air flow can be changed by adjusting the discharge valve position. The recent energy audit recommended that the blowers providing air to the aerated grit channels be replaced for better efficiency – however, if an alternative grit technology is recommended this may be an unnecessary investment. Staff has also indicated that the air piping and the clam shell system have reached their useful life.

Flow from PS2 typically flows to Primary Influent Shaft No. 5 and subsequently to circular primary clarifiers 13 through 18 or can be conveyed to the Primary Influent Junction Chamber where it is mixed with flow from PS1 and conveyed to rectangular primary clarifiers 9 through 12. Flow to each clarifier or group of clarifiers can be isolated with slide gates.

7.4.3 Recent and Planned CIP Projects

The following projects were included in the 2020-2024 Capital Improvement Plan (CIP).

- **CIP 211002 Pump Station No. 2 Improvements – Phase I**

This active project involves evaluating and recommending alternatives for providing more reliable pumping capacity at PS2 for pump nos. 11 and 14 and is expected to be complete in FY20.

- **CIP 211004 Pump Station No. 1 Rack and Grit and MPI Sampling Improvements**

This active project includes modification and improvements to the grit and screening handling system at PS1. Once the current PS1 upgrades project is completed (expected in FY20), the eight ¾” catenary bar screens will be new. Two of the grit collection systems will not be renovated. Operators have found the new grit collection equipment (bucket, shear pins) fails more often than the older system.

- **CIP 211005: Pump Station No. 2 Improvements Phase II**

This future planned project entails providing a basis for design report for the rehabilitation/rebuilding plan for existing pumps and controls to improve pump reliability and meet NPDES permit flow capacity requirements. Consideration will be given to adding VFDs to the three constant speed pumps. The scope also includes replacement of the HVAC system, I&C improvements, structural, architectural and electrical improvements. This project is currently scheduled to commence in FY21.

- **CIP 211006: Rehabilitation of Pump Station No. 1**

GLWA recently awarded a contract to study the condition of and design improvements to all pumps in Pump Station No. 1. Scope includes rehabilitation/rebuild of existing pumping units, improvements to major process piping, valves, and gates, potential addition of a variable speed controller (including VFD’s and eddy current drives at a minimum); as well as facility architectural, structural electrical, instrumentation, and HVAC improvements. Evaluation of influent flow meters for each pump is included in the scope of this work.

- **CIP 211007: Pump Station No. 2 Bar Rack Replacement and Grit System Improvements**

This is a future planned project designed to replace all bar racks and grit collection equipment and associated equipment for more reliable and efficient operations. This work is scheduled to commence in FY20.

7.4.4 Evaluation of Near-Term and Long-Term Upgrades to Pumping and Preliminary Treatment

This section first describes options for improvements to the screening and grit facilities at both PS1 and PS2.

Modifications to PS1 are not presented herein since upgrades to this pumping station are now underway through the recently awarded CIP 211006 Rehabilitation of Pump Station No. 1 Project. Based on the Master Planning work, CIP 211006 should include flow metering at this station, assess the ability to measure and sample sidestream flows independently from influent flow, include the ability to increase pumping head to easily accommodate future systems.

The construction of a new PS3 was evaluated but dismissed, given the proposed rehabilitation of the two existing pumping stations and the number of new assets required for a functional PS3. The potential to provide a new connection from the Oakwood Interceptor to PS2 to allow draining of this interceptor was also evaluated and is presented in Technical Memorandum 5A.

7.4.4.1 Screen Technology Evaluation

Effective screening has been shown to provide many benefits including improved grit pumping reliability, reduced downstream pump ragging, reduced vertical shaft mixer maintenance, and the production of a more visually appealing and marketable biosolids product. Certain downstream processes under consideration for GLWA, such as high rate clarification, stacked tray grit removal, and grit pumping requires effective upstream screening to minimize clogging of the pumps and tube or plate settlers. As the plant has moved from incineration to the biosolids drying facility the pass-through of grit and screenings to the biosolids treatment process is more evident. In addition, as the technology has advanced, the industry is moving toward the use of fine screens as standard practice in order to assure the value of investment in downstream equipment. As such, installation of a mechanical fine screen, downstream of the existing coarse screens in PS1 and PS2 to improve the removal of rags, stringy material, and other non-biodegradable material is evaluated herein.

Fine screens are effective at removing non-biodegradable material, but also remove organics which can cause odors in the screenings collection and handling area. To remove organic material from the screenings, installation of washer/compactor unit(s) in addition to the fine screens is also evaluated. These units remove organic material from the screenings and reduce screening volume for more efficient off-site transport and potentially a reduced rate (\$/ton) for landfill disposal since the product is much easier to manage.

Installation of coarse screens ahead of the influent pumps to protect the pump impellers from large debris was also considered but was dismissed due to space requirements, the potential for blinding of screens under high flows and difficulty removing screenings collected from the depth of the influent interceptors (approximately 45 feet below grade).

A number of different types of coarse screens and fine screens are were evaluated. Based on our review of screening technologies available, their performance on large combined sewer systems and discussions with GLWA staff, a two-stage screening system is recommended. The existing $\frac{3}{4}$ inch catenary bar screens should remain as first stage “pre-screens” to capture exceptionally large material (e.g. large rocks, pieces of concrete, pallets) that are ejected by the main plant influent pumps at high velocity and may damage less robust downstream fine-screens. Consideration could be given to 1-inch (or larger) coarse screens to minimize headloss, given that fine screens would follow. GLWA operations staff is familiar with this type of screen, it has overall functioned well, and the existing screens in PS1 have recently (2013) been replaced with new $\frac{3}{4}$ inch catenary bar screens. Existing catenary screens in PS2 are slated for replacement in the 2020-2024 CIP. It is recommended downstream fine screening be either a 10-mm or 6-mm fine screen, multi-rake screen. During preliminary design, the evaluation should also consider climber-style coarse screens. Climber screens tend to be less expensive and easier to maintain than multi-rake screens, but clean less frequently. Headloss through the fine screens is an important consideration. For the purpose of this Master Planning fine screens have been located at the head end of the grit tanks where a deeper screen could be installed to minimize headloss.

Installation of washer/compactors on screenings discharge to reduce the quantity of organics on screenings, reduce screenings odor, and to minimize the volume of material hauled offsite is also recommended. Care will need to be exercised in the washer/compactor design to ensure the system operates without jamming and other chronic maintenance issues. Consideration could be given to only transferring fine screens captured to the washer/compactor and discharging coarse screenings directly to a dumpster. Design details, related to screening conveyance (conveyors or sluice), number of and location of washer compactors, whether or not grinding is employed should be revisited during design.

7.4.4.2 Grit Technology Evaluation

Just as the industry is moving toward fine screening as a standard practice, the industry is also moving to achieve a higher percent removal of smaller grit particles. Grit systems were traditionally designed to remove 95% of particles larger than 200 microns (65 mesh) with a specific gravity of 2.65. There is now an increasing demand to design grit systems capable of removing up to 95% of 100 micron (150 mesh) grit particles to avoid adverse effects on downstream processes. The existing grit systems at GLWA were likely designed to achieve the traditional criteria. As GLWA moves from incineration and/or landfilling of biosolids to resource recovery the impetus for a “cleaner” biosolid with less grit and screenings is clear as a higher quality product garners lower disposal costs and can result in revenue for a superior product. For instance, the Milwaukee Metropolitan Sewerage District reports a revenue of \$10 million annually for their Milorganite fertilizer product that they have been producing since 1926. There are generally six types of grit removal technology available that were reviewed as a part of this Master Plan:

- Constant velocity tanks (as installed in PS1)
- Aerated grit (as installed in PS2)
- Vortex systems
- Stacked tray

- Plate Settling
- Primary sludge degritting

Based on our review of the technologies available, performance of the existing systems, expected performance of an alternative system, the space requirements of alternative technologies and the ease with which the existing system could be modified, two alternatives were further evaluated – optimizing the existing grit tank performance and grit removal system and installation of a new grit removal technology.

Grit Tank Optimization. A key design parameter of either existing type of grit removal (constant velocity at PS1 or aerated at PS2) is the detention time and tank dimensioning. As a result of the evaluation presented in Technical Memorandum 5A, the following conclusions can be gleaned regarding the performance and optimization of the existing grit removal tanks.

Pump Station No. 1:

- Theoretically, the available detention time in PS1 constant velocity tanks is sufficient to settle out 70 to 90% of the influent grit load under all flow conditions.
- In practice, based on information collected from GLWA's Energy, Research and Innovation (ER&I) group, only 16% of grit is removed from PS1.
- Inefficiencies in the design of chain and bucket grit collection equipment significantly impact grit capture.
- The existing grit tank dimensioning at PS1 is not ideal for conversion to aerated grit, based on the available detention time, width:depth and length:width ratios of the various channels.
- If fine screens are constructed at the head end of the grit tank (in the location of the chain and bucket grit collection equipment) an alternative means of grit collection would be required, and detention time would be shortened.

Pump Station No. 2:

- The existing aerated grit chambers are slightly wider than typical but have an appropriate length:width ratio for successful grit settling.
- Assuming grit particle size distribution at PS2 as was measured at PS1, 55% to 80% removal of grit is expected, depending on flow.
- The clam shell grit removal mechanism is labor intensive and inefficient requiring at least one full week to complete the cleaning of one tank, and results in only about 14% capture, based on data collected from GLWA's ER&I group.
- If fine screens are constructed within the footprint of the existing grit tanks, grit capture would become less efficient with shortened detention time, and modified length:width ratio.

Based on this information, it is clear that although the tanks are sized appropriately to achieve a fair amount of grit removal, once settled, removal from the tank is problematic and therefore results in grit carryover. Therefore, alternatives to remove grit captured from the existing tanks in PS1 and PS2 were investigated. Generally, grit is conveyed to a hopper by a screw conveyor or chain and flight mechanism and then removed from the hopper by grit pumps, screw conveyors, bucket elevators, clam shells or airlift pumps. Each grit removal mechanism has their own challenges, whether it be equipment located under water in a harsh environment that must be maintained, rat-holing exhibited by some pumping applications, and/or inability to manage peak loadings.

At PS1 a chain and bucket system exists which draws the grit to the head end of the tank. Buckets are then drawn up to the surface to discharge grit collected onto a belt conveyor. The flaw in this system is that the buckets pass in front of the forward flow into the tank which washes the collected grit out of the buckets. Under CIP211004, coarse screens and the chain and bucket collection system was replaced, however, the grit collection is still woefully shy of where it should be after a significant investment. Since PS1 grit tanks were not designed with a sump, either the base slab would have to be cut out, or the floor slab built up to accommodate a sump. A submersible grit pump or air lift pump could lift the grit to the surface in a pipe without being disrupted by the forward flow. Consideration could be given to pushing settled solids to the end of the tank versus the front of the tank, but still a sump would be required and a means to lift grit to the surface without disruption.

At PS2 the aerated grit tanks are designed with a sump to collect the grit, and a clam shell bucket travels overhead above the centerline of the sump. Again, the issue isn't as much about the capacity of the grit tank to settle out the grit but more about the mechanism of removing the grit once settled. Since the grit is not removed from the system as quickly as it should be grit carries over into the primary settling tanks. Alternative pumping or air lift systems could be investigated, but experience shows that these systems are not perfect and a higher level of grit removal may not be achieved.

If the existing grit tanks are maintained with a modified grit removal system, it is still expected that the percent removal will not be ideal. Depending on the ultimate solids handling system, the need for primary sludge degritting may be required to reduce maintenance of downstream sludge handling equipment and cleaning of downstream tankage.

New Grit Removal Technology. As an alternative to maintaining existing grit tanks alternative grit removal solutions were evaluated including vortex grit removal, stacked tray grit removal and plate settling. Based on the footprint required to meet the design capacity, and the operability of the systems, the stacked tray system appears to be the most viable solution. Although the vortex units have demonstrated experience at a number of large-scale wastewater treatment facilities, the required footprint is in excess of the existing grit tanks for PS1 to achieve the same treatment capacity. The vendor for the plate settler which is new to the market, was not comfortable recommending this unit given the size of the GLWA system. The stacked tray units fit within the footprint of the existing grit tanks at both PS1 and PS2, and have experience with a large-scale installation on a combined system in Atlanta, GA. For PS2 the stacked tray units could be designed to fit well within the existing aerated grit tank footprint with limited structural modifications. Although the stacked tray system could fit within the available footprint at PS1, the depth of the

existing grit tanks could not accommodate a 12-tray system. An 8-tray system could be accommodated but with a reduced capacity.

An overview of advantages and disadvantages of each alternative is described in Table 7-6.

Table 7-6. Summary of Alternatives with the respective advantages and disadvantages

Alternative	Advantages	Disadvantages
Maintain existing conditions – no action	No structural modifications required.	Poor grit capture and adverse impacts downstream. Intensive O&M
Optimization of existing facilities	Ease of construction Lowest cost of the “do-something” alternatives	Likely a minimal increase in grit capture Doesn’t alleviate O&M of existing processes
Conversion to aerated grit	Existing conditions at PS2 Extensive operational experience	Non-ideal geometry and detention time at PS1 will likely decrease grit removal Challenging removal of captured grit
Headcell™ Stacked Tray Grit Removal	Vendor provided system with performance guarantee Proven performance Relatively easy conversion at PS2	Number of units required. Numerous new assets to maintain. Requires modification of PS1 structural piles, or compromise on system capacity; single vendor
Custom large Stacked Tray Grit Removal (>12-ft. diam.)	Reduced assets compared to the Headcell™ system Relatively easy conversion at PS2 Reduced number of pumping assets	Would require development of a new product Likely no performance guarantee Potential patent infringement Requires modification of structural piles at PS1 or capacity limitations based on existing footprint
GritWolf® Plate Grit Settler	Vendor provided system with performance guarantee	Numerous new assets to maintain New system with minimal experience, especially at big plants No vendor interest at this time
Addition of lamellas to existing grit tanks	Likely easy to construct Low capital cost Maintains existing tankage Decreases settling distance and as such improves grit capture	Risk of screenings plugging the stacked plates Minimal (if any) experience in the water sector Challenge in removing captured grit
Vortex grit removal	High capacity per unit (100 mgd) Reduced number of new assets compared to the Headcell™ system Multiple qualified vendors	Potentially high headloss Exceeds available footprint at PS1 and PS2 Requires modification of PS1 and PS2 structural piles
Sludge dewatering	Extensive industry experience	Odorous Likely requires continuous sludge pumping (i.e. energy inefficiency) High headloss through the cyclone (i.e. energy inefficiency) Requires thin primary sludge

Based on this analysis it is proposed that PS2 be retrofit with a stacked tray system first. Information gleaned from the operation of this system could be used to inform the design at PS1.

7.4.5 Summary of Preliminary Treatment Alternatives

Providing a robust, well operated and maintained, influent pumping and preliminary treatment system improves the efficiency and performance of all downstream processes and assures the value of the investment in these processes. Although plant staff has maintained the operations of the existing systems, challenges inherent in the design of the existing systems can no longer be ignored. Only a transformative project, that significantly changes the way screenings and grit are removed and handled with state-of-the-art technologies can move these systems forward. The following projects are recommended:

- PS2 and associated Preliminary Treatment Improvements
- PS1 Preliminary Treatment Improvements (PS1 Improvements currently ongoing)

Since preliminary treatment improvements were recently completed at PS1 and pump improvements are underway it is recommended that preliminary treatment improvements commence at PS2.

7.4.5.1 PS2 and Associated Preliminary Treatment Improvements

Upgrades and improvements to PS2 and the associated grit and screening systems are designated “future planned projects” in the current CIP (211005 and 211007) receiving high marks in terms of prioritization. The Master Planning evaluation confirms that it is imperative that these projects move forward in a timely fashion to maintain EGLE-NPDES required capacity by improving the reliability of the existing system, and suggests that the project be enhanced to include the following project optimizations:

- Addition of fine screens downstream of coarse screens for more reliable and efficient screenings removal
- Addition of screenings washing and compaction to improve screenings handling
- Upgrade of grit removal within the existing aerated grit tanks with a stacked tray system for improved grit removal
- Addition of grit washing and/or classification for improved handling of grit.

Improvements to the pumping station should include an assessment of the pumping hydraulics and pumping efficiencies over the range of expected flows, accurate flow metering, pumping head required for the new downstream systems and upgrades to all support systems to bring the station up to current codes and standards.

Improvements to the screenings and grit removal and handling systems with state-of-the-art systems will markedly improve the performance of all downstream processes, increasing the system reliability, reducing downstream maintenance costs and increasing the life of downstream equipment, thereby ensuring the value of investment. These improvements, however, are costly and increase the assets to be maintained.

Given the size of the influent pumps exceptionally large material (e.g. large rocks, pieces of concrete, and wooden pallets) can be ejected at high velocity by the pumps which may damage potentially less robust fine-screens. As such, we propose maintaining the catenary coarse screens ahead of the fine screens. During preliminary design, evaluation of the feasibility of single stage fine-screening versus two-stage screening, as well as the type of screen, could be evaluated with specific attention to screen damage from large debris and blinding under high loading scenarios prevalent in combined collection systems. Consideration could be given to 1-inch (or larger) coarse screens to minimize headloss, given that fine screens would follow. Sufficiently large coarse screens would only capture exceptionally large material therefore, it is proposed that this material be conveyed directly to a dumpster without washing and compaction. It is recommended that downstream fine screening be either 10 mm or 6 mm multi-rake screens. If space and head allow, the fine screens could be located within the existing building immediately downstream of the coarse screens. Alternatively, the new fine screens could be located at the head end of the existing grit tanks.

To best make use of existing infrastructure, eight screens of each type (coarse and fine) are recommended. With a capacity of 115 mgd each, this would provide seven duty and one standby screen at the design firm capacity of the pump station of 805 mgd.

Prior to final selection of the grit removal technology GLWA could pilot the stacked tray grit removal system by Headcell™ to get a better understanding of expected removal efficiencies under varying flow and load conditions, the operations and maintenance associated with the system, and to fine tune the design criteria of the system. Piloting would require fine screenings ahead of the grit system. GLWA staff could also schedule a visit to the R.M. Clayton facility in Atlanta, GA which currently operates stacked tray units to manage a peak flow of 320 mgd, or to more local, yet smaller facilities.

Twenty Headcell™ stacked tray grit removal units are required with a design capacity of 46 mgd each to provide 18 duty units and 2 standby at the design firm capacity of the pump station. The number of units could be optimized during preliminary design by considering alternatives to bypass a portion of flow during peak flow conditions. The conceptual design also assumes one standby grit pump for each set of two stacked tray units, one hydrocyclone for each stacked tray unit, and one grit classifier for each set of two stacked tray units. The number of hydrocyclones and classifier units could be also optimized during preliminary design.

As part of Preliminary Design, Computational Fluid Dynamics (CFD) modeling should be used to evaluate hydraulics through the entire pumping and preliminary treatment system including various channel configurations to evaluate strategies to reduce grit and screenings deposition ahead of the treatment processes. The limited CFD modeling performed as a part of Master Planning revealed the potential for grit accumulation in the pump discharge channel and screen influent channels under average flow conditions where velocities are less than 1 fps. When more screens are operated than pumps (as is typical), velocities in the channels will reduce, resulting in further grit deposition in these channels. Under peak flow conditions, the model predicts significant mal-distribution of flow between screen channels.

This project will significantly change how screenings and grit are removed from the process flow stream and have far reaching benefits for plant operations in every downstream unit process.

Certainly, removing a significant quantity of grit and screenings at the head of the plant, before this material flows downstream, will reduce maintenance of downstream assets including reducing pump clogs, reduced wear of downstream pump impellers and sludge handling equipment, and reduced shearing of pins on primary sludge collection mechanisms. In addition, the removal of more grit and screenings up front will reduce sludge production and increase VSS in sludge thereby generating a cleaner, more valuable biosolids product. Should anaerobic digestion be employed, removing grit up front is imperative to reduce cleaning requirements of the digesters.

By washing and compacting/dewatering the screenings and grit removed, the organics are put back in the flow stream which can benefit the operations of the secondary system and energy production (if digestion is included), and the material removed from the site is less odorous. Washed and dewatered grit could be considered a beneficial product and could be re-used at the landfill as daily cover.

The construction of this project will be challenging and must consider maintaining plant operations during construction. Coordination of the construction schedules between PS1 upgrades and PS2 upgrades must ensure plant capacity is maintained during construction.

Ancillary needs for the new grit and screening systems cannot be overlooked and should be coordinated with ongoing review and overhaul of the plant infrastructure. The connected electrical load of the new systems will increase due to the additional equipment required for handling of the grit and screening. It is imperative that the electrical systems be reviewed and upgraded as necessary to provide a robust and resilient power feed to the new pumping and preliminary system, since the total horsepower with multiple units in service is not insignificant. In addition, the stacked tray grit removal units require a fair amount of screened final effluent (SFE) to fluidize the grit in the units to facilitate removal (1.3 mgd peak). The quantity of SFE will go up if sluices are used for screening conveyance in lieu of conveyors. The capability of the existing SFE infrastructure to deliver the required quantity of water must be assessed during design and should be incorporated in ongoing improvements to the WRRF infrastructure.

Figure 7-8 and 7-9 present a preliminary layout and section of a new preliminary treatment system at PS2.



Figure 7-8. Preliminary Screening and Grit Treatment Layout PS2

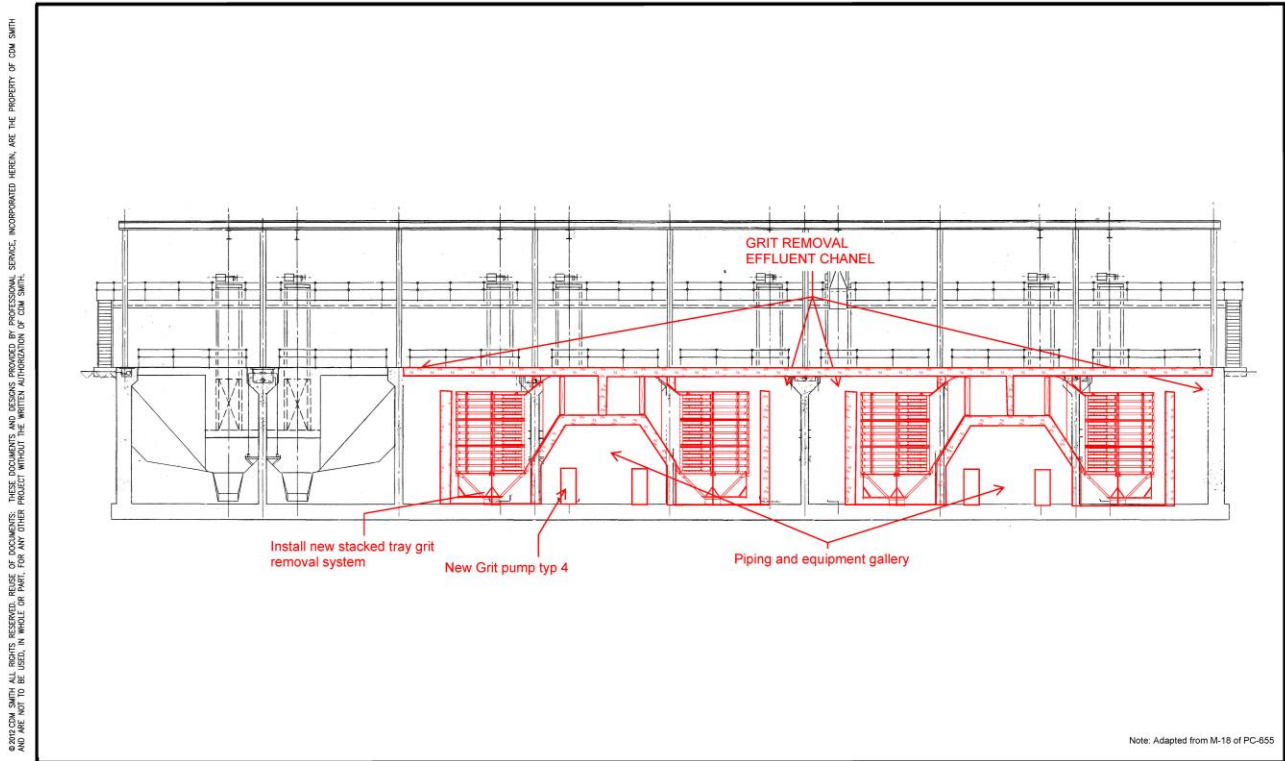

Figure 7-9. Section View of Stacked Tray Grit Removal in Existing Grit Tanks

7.4.5.2 PS1 Preliminary Treatment Improvements

Planning for upgrades and improvements to PS1 are already underway (211006) and should be coordinated with the proposed upgrades recommended herein, specifically with respect to increased head requirements that may result from the upgraded preliminary treatment system. As with PS2 preliminary treatment, the Master Planning evaluation confirms that improvements to the preliminary treatment at PS1 is imperative to improve the overall performance and reliability of the treatment facility. The proposed project would include:

- Replacement of the existing coarse screens when they reach their useful life
- Addition of fine screens downstream to coarse screens for more reliable and efficient screenings removal
- Addition of screenings washing and compaction to improve screenings handling
- Upgrade of grit removal and handling within the existing constant velocity grit tanks or installation of a stacked tray system to improve grit removal and handling, and
- New grit washing and/or classification for improved handling of grit.

Improvements to the screenings and grit removal and handling systems with state-of-the-art systems will markedly improve the performance of all downstream processes, reduce downstream maintenance costs and increase the life of downstream equipment, thereby ensuring the value of investment.

The scope of work for improved grit and screening for PS1 is very similar to PS2 as described above, however the sheer size of this pumping station, as well as the fact that the existing screening and grit channels are dedicated to a specific pump make the planning, design and construction of this system more challenging.

To best make use of existing infrastructure, eight screens of each type are recommended. Coarse screens sizing and capacity would match existing to make use of existing assets. Although these screens were recently replaced, it is expected that they will have reached their useful life by the time this project is implemented and will be in need of replacement. If this is not the case, the existing screens could be maintained and/or rehabilitated and replaced at a later date. Fine screens would be located downstream of a cross-connecting channel, placed in the position of the existing chain and bucket grit collection system, and likely standardized at 175 mgd each with seven duty and one standby fine screen to meet the design firm capacity of the pump station of 1,225 mgd. This cross-connecting channel de-couples the pumps and coarse screens from the fine screens and grit systems.

Twenty-eight stacked tray units are required with a design capacity of 46 mgd each to provide 27 duty units and 1 standby at the design firm capacity of the pump station. This is slightly less redundancy than provided at PS2, however, for the stacked tray system, which has no moving parts, the redundancy is provided in the pumping system. As with PS2, a passive bypass (weir) could be included in the design to allow bypassing the grit removal system during extreme peak storm events. Operations of the system at PS2 will help inform the design criteria to be used in the construction of this system. The 12-tray unit would require demolition of the base slab, however an

8 tray unit could be installed without modification to the base slab, but would reduce the installed capacity to 840 mgd, requiring more frequent bypass of the grit system. The design of the bypass could be such that some level of grit removal would be achieved.

Alternatively, a more efficient means to remove grit from the existing constant velocity grit tanks could be assessed during preliminary design. It is likely that the tank foundation would have to be modified to incorporate a grit sump and a pumping system to more effectively remove grit from the tanks would be required. The present worth cost and effectiveness of this system could then be compared against the stacked tray system. Data collected on the cost and effectiveness of the new system installed at PS2 could help inform this analysis.

As with PS2, the benefits of significantly improved grit and screening removal will have far reaching benefits plant wide. The benefits will likely be even more significant at PS1 which accepts the larger proportion of flow and grit and screening load from the combined service area. With increased screening and grit removal comes the challenge of providing adequate facilities to effectively and efficiently remove the collected materials, especially during storm events when the loadings can increase five-fold or more. Sizing of the screenings and grit handling equipment is a critical cog in the system – since the system’s performance is only as good as the system’s weakest link. The amount of new equipment requiring maintenance will increase significantly. Proper attention to the system, as well as an appropriate design that provides sufficient, space, lighting, SFE and ancillary facilities required for maintenance is imperative.

As with PS2, the connected electrical load will increase with the added equipment and the need for significant quantity of SFE to fluidize the grit in the unit and, if desired, for sluicing the screenings. The capability of the existing power and SFE infrastructure to convey the necessary loads to PS1 cannot be overlooked.

Maintenance of plant operation during construction is especially challenging at PS1 since currently the pumps are dedicated to the screens which are dedicated to the grit channels. It is proposed in the future that the units would be decoupled downstream of the coarse screens. Nevertheless, construction and construction sequence will be more challenging at this station.

7.5 Primary Treatment

7.5.1 Introduction

Primary treatment includes the assessment of the performance and reliability of both the existing rectangular and circular primary clarifiers and alternatives available to supplement or replace existing systems to improve primary effluent quality and/or operability. When influent flow exceeds the secondary treatment capacity of 930 mgd primary effluent is disinfected and discharged. Therefore, improved effluent quality will reduce pollutant loadings to the natural environment during wet weather conditions. Increased BOD and TSS removal efficiency in primary treatment can also be beneficial in reducing oxygen demand in the secondary treatment system, and/or in increasing energy production in solids handling. Ferric chloride addition to improve primary effluent phosphorus limits is also discussed herein and expanded upon in the discussion of secondary treatment as it relates to biological phosphorus removal.

From a Master Planning stand point the following challenges are addressed in this section:

- the long-term integrity of the rectangular clarifiers, eight that are over 80 years old
- the effluent quality of primary effluent, especially under high flow events
- the impact of ferric chloride addition on primary effluent quality and secondary system influent quality

7.5.2 Existing Conditions

Primary treatment is currently achieved through 12 covered rectangular clarifiers and 6 circular clarifiers. During dry weather flow from PS1 flows by gravity to the 12 rectangular clarifiers and flow from PS2 flows by gravity to the 6 circular clarifiers. During wet weather conditions a portion of the flow from PS1 can be directed to the circular clarifiers. Flexibility also exists to allow flow from PS2 to be treated in rectangular clarifiers 9-12.

Each rectangular clarifier, rated at 90 mgd, has an identical surface area, although clarifier nos. 1 through 8 have a 14-foot side water depth (SWD) compared to a 10-foot SWD for clarifier nos. 9 through 12. The rectangular primary clarifiers are below grade structures covered with concrete slabs and earth, thus any maintenance within the tanks requires confined space protocol. The six circular clarifiers nos. 13 through 18, rated to treat 180 mgd, have identical dimensions. Each clarifier is 250-ft diameter and has a sidewater depth of approximately 11 feet and a center depth of approximately 25 feet. The total installed primary treatment capacity is 2,160 mgd, and the total firm capacity, assuming two circular clarifiers are out of service is 1,800 mgd.

The primary clarifiers are currently designed with overflow rates at or over typical design standards, even with chemical addition as presented in Table 7-7. This assumes flow is distributed proportionally among the operating clarifiers.

Table 7-7. Primary Clarifier Overflow Rate

	Average	Peak
Standard Design Overflow Rate (gpd/sf)	800 – 1200	2000 - 3000
Rectangular Clarifier Overflow Rate (gpd/sf)	1,090	2,940
Circular Clarifier Overflow Rate (gpd/sf)	1,360	3,670

Despite the high overflow rates, the rectangular clarifier performance testing revealed the clarifiers perform fairly well achieving on average 70% TSS removal when the overflow rate is less than 3,500 gpd/sf. The circular primary clarifier testing revealed a much stronger correlation between overflow rate and solids removal. About 70% TSS removal was achieved at an influent overflow rate of 1,700 gpd/sf. This decreased to 40% TSS removal at the highest overflow rate tested of 5,300 gpd/sf.

When Master Planning commenced ferric chloride (ferric) was added as a 37% solution at three locations upstream of the primary clarifiers to enhance clarifier performance and remove phosphorus: (1) DRI upstream of PS1; (2) Oakwood Interceptor upstream of PS1; and (3)

downstream of PS2 grit chambers. The same ferric dose was used across all three dosing locations, with 1.5 mg/L (as Fe) targeted during dry weather and 2.5 mg/L (as Fe) during wet weather. Total ferric used per day ranged from 3,000 gpd (7 dry tons/day of FeCl_3) to 10,000 gpd (21 dry tons/day of FeCl_3) or more, at an average annual cost of about \$2 million.

Control of the ferric dosing rate is performed manually based on a target total phosphorus (TP) in the primary and secondary effluent.

7.5.3 Recent and Planned CIP Projects

The following projects were included in the 2020-2024 CIP.

- **CIP 211001 Rehabilitation of Primary Clarifiers, Rectangular Tanks, Drain Lines, Electrical, Mechanical Building and Pipe Gallery**

The work underway in this project includes ventilation and atmospheric control for the pipe gallery, new lights and emergency lighting, rehabilitation of the 12 drain lines from rectangular clarifier nos. 3-12 and circular clarifier 16, installation of a drainage manhole with sump pumps, concrete repairs and rehabilitation work in the electrical/mechanical building.

- **CIP 211008 Rehabilitation of Ferric Chloride Feed System**

This project was recently awarded and includes the study and design of upgrades to the ferric chloride storage and feed systems. The study includes an evaluation of alternative application points, as well as alternative storage tank locations, and online control of ferric addition.

- **CIP 211009 Rehabilitation of Circular Primary Clarifier Scum Removal System**

This future planned project includes the study and design of new scum equipment for the circular clarifier system. The study will include alternatives for scum disposal.

7.5.4 Evaluation of Near-Term and Long-Term Upgrades to Primary Treatment

The existing primary treatment system has served GLWA well over the years. The rectangular clarifiers, part of the original plant construction, continue to produce high quality primary effluent due, in part, to the weak influent loading and, in part, due to the ferric chloride dosing which results in the facility operating in essentially a chemically enhanced primary treatment (CEPT) mode. The circular clarifiers represent newer infrastructure and also serve GLWA well. Challenges with the rectangular clarifiers stem from the necessity for confined space entry when working on the tanks, the high grit loading which can tax the sludge collectors and cause chain failures, and the overall age of concrete, gates, and other ancillary equipment. Scum collection on the circular clarifiers is in need of repair and is included in the 2020-2024 CIP.

Understanding that eight existing rectangular clarifiers date back to the original plant construction in the 1930s consideration was given to sequentially replacing some or all of these units with a high rate clarification system as a long-term solution. The benefits of this would result in:

1. higher quality primary effluent discharged during high flow events,

2. targeted chemical addition to reduce ferric chloride use
3. replacement of some of the facility's oldest infrastructure, and
4. more efficient use of space on-site which frees up real estate for other uses.

Primary filtration was also examined as an option for replacement of the rectangular clarifiers, however this technology was dismissed due to limited experience at large facilities, required backwash volumes, and system hydraulics.

With respect to near-term improvements, optimization of the existing ferric chloride addition system was investigated as discussed below.

7.5.4.1 Ferric Chloride Addition Optimization

Ferric chloride addition will continue to be an integral component of the WRRF's permit compliance, at least in the near-term, so optimization of the dose and feed locations was considered as part of the Master Planning effort. Specifically, two alternatives to the existing "constant dose" approach were investigated: (1) a tailored dose approach, wherein the ferric chloride dose is different at each of the three dose points based on influent phosphorus concentrations and (2) discontinuation of one of the dosing points (DRI), combined with initiation of dosing at the end of the aeration decks/before the secondary clarifiers. For the tailored dose approach, online phosphorus measurement would facilitate automatic adjustment of the ferric dose. Adding a dosing point near the secondary clarifiers would reduce overall chemical use by more effectively leveraging biological uptake of phosphorus, although care would need to be taken to ensure adequate mixing at the selected dosing point.

As shown in Table 7-8, total ferric chloride use with either of these alternatives would be lower than the baseline chemical use with the constant dose approach. The doses and volumes shown in Table 7-8 are based on achieving 0.48 mg/L TP in secondary effluent at 2045 design flows and loads.

Table 7-8. Ferric Chloride Dose and Volumes Required for Alternative Dosing Approaches

Alternative	Number of Addition Points	Expected PE Ortho-P (mg P/L)	Chemical Dose (mg Fe/L)	Total Ferric Chloride Required (gpd)
Constant Dose	3	0.50	DRI: 1.5 Oakwood: 1.5 PS#2: 1.5	5,430
	3	0.50	DRI: 2.5 Oakwood: 2.5 PS#2: 2.5	7,240
Tailored Dose	2 No addition to DRI	0.70	DRI: 0 Oakwood: 1.0 PS#2: 3.1	4,750

Alternative	Number of Addition Points	Expected PE Ortho-P (mg P/L)	Chemical Dose (mg Fe/L)	Total Ferric Chloride Required (gpd)
Relocated Dosing Point	3 No addition to DRI New dosing point before secondary clarifiers	0.70	DRI: 0 Oakwood: 0.77 PS#2: 2.8 Secondary: 0.20	4,560

Ferric chloride optimization will occur in multiple phases. The first phase of optimization is ongoing based on recommendations made as a part of this Master Planning and relates to optimization of ferric addition based on existing conditions and permit requirements. The next phase of optimization will come with the implementation of biological phosphorus removal in the secondary system (described in Section 7.6). And the last phase will be associated with the implementation of high rate clarification for high flow and/or primary treatment. It is essential that the ongoing work under CIP Project 211008, the Rehabilitation of the Ferric Chloride Feed System, be coordinated with the work performed as a part of this Master Plan to ensure the value of investment of new ferric storage and feed facilities installed. This could include the installation of an additional ferric feed point upstream of the secondary clarifiers, inclusion of on-line phosphate analyzers, optimized chemical tank storage volume, and appropriate siting of the new storage tanks to avoid conflicts with future facilities.

Today, optimized chemical addition for phosphorus removal has the potential to reduce the average day chemical from 6,200 gpd to 3,100 gpd. This corresponds to a cost savings of \$800,000/year and a reduction in truck traffic of more than 100 chemical delivery trucks per year. The reduction in ferric chloride addition also results in a commensurate reduction of inert ferric sludge that must be managed and disposed of offering further cost savings. GLWA has already moved towards optimized chemical dosage based on recommendations resulting from this Master Planning.

Since this idea was brought forth to GLWA in January 2019, the operations staff has developed and implemented procedures to reduce ferric chloride addition by targeting the dosage to each influent sewer, rather than a set dosage across the entire plant. The plant has achieved success with this operational strategy and is continuing to fine tune and reduce chemical addition. Sharing of this data with the consultant responsible for CIP 211008 is critical to optimize chemical tank sizing and location. In addition, inclusion of a ferric chloride feed point just upstream of the secondary clarifiers is recommended to be incorporated in CIP 211008, to provide the ability to further reduce total phosphorus in the secondary effluent if need be. Lastly, the inclusion of real-time phosphate analyzers to inform the existing manual dosing, with the movement towards automatic dosing based on the analyzers is recommended.

7.5.4.2 High Rate Clarification

High rate clarification (HRC), or ballasted flocculation, involves the rapid dispersion of a metal coagulant/polymer/ballast mixture, followed by flocculation and settling. The superior particle

removal achieved with ballasted flocculation makes the process ideal for enhanced primary treatment prior to secondary treatment or for use during wet weather.

There are three main types of high rate filtration processes that could be used for enhanced primary treatment: the ACTIFLO® system by Kruger, Inc., the CoMag® system by Evoqua, and the DensaDeg® system by Infilco Degremont Inc. Each system utilizes a different ballast, which results in significantly different design criteria, footprints and system layouts. Due to the limited experience with CoMag and DensaDeg® at large scale facilities, ACTIFLO® was used as the basis of this evaluation. An ACTIFLO® system was recently installed by DC Water at the Blue Plains facility for high flow management. Technology and vendor experience in this field is rapidly advancing, as such each technology should be more fully evaluated prior to final design of high rate clarification for advanced primary or wet-weather treatment.

Incorporation of HRC, in this case ACTIFLO®, for wet weather treatment and/or primary treatment would require decommissioning two rectangular primary clarifiers nos. 1 and 2 (180 mgd capacity) to replace with six HRC trains with a total capacity of 500 mgd. The HRC train would consist of a coagulation tank, maturation tank, and sedimentation tank and a new equipment building. Ferric chloride would be added as the screened and degritted flow enters the coagulation tank, in the flocculation tank polymer and microsand are added to enhance particle size and settling characteristics. The coagulated/flocculated/ballasted wastewater then enters the settling tank where rapid settling occurs with tube settlers. Sludge is collected and pumped through a hydrocyclone where the microsand is recovered and returned to the process. Sludge would be wasted to the gravity thickeners.

If used for high flow treatment alone, the system would be brought on-line when influent flow exceeds the capacity of the secondary treatment system (currently 930 mgd). At an influent flow >1,430 mgd, HRC effluent would be blended with primary clarifier effluent for discharge.

The HRC system can remove 80-85% TSS and 60-65% BOD depending on the influent fractionation. Due to the ferric chloride addition necessary to coagulate and flocculate the wastewater, low effluent phosphorus is also expected, <0.7 mg/L. This removal efficiency would significantly improve the quality of wet weather discharge as compared to the existing conventional primary treatment. The chemical dose during use of the HRC system will be higher than the existing primary clarifiers however, the targeted dose to the wet weather discharge could eliminate the need to dose during dry weather if biological phosphorus removal is employed in the secondary system. This enables dosing to the dedicated bypass flow stream versus all influent flow.

Addition of this new process will likely increase the reliance upon automation to bring the system and trains online, it would also increase the number of new assets to be maintained. System hydraulics could be challenging and a more detailed analysis of the system hydraulics must be undertaken to ensure influent and effluent conditions can be met. This could include the need for increased pumping head for some (if dedicated) or all of the PS1 pumps.

Given the other more immediate needs at the WRRF, it is expected that the planning of this project would not commence until at least 2035. As time passes and the condition of the existing primary clarifiers continues to deteriorate and the cost of maintaining the existing equipment becomes more costly, conversion to high rate clarification may be warranted. Modification to the effluent

discharge permit, and/or need for additional real estate on site for other treatment processes may also be the impetus for change. At that time, the sizing of the facility should be reassessed based on current influent flows, specifically storm induced flows. Effective upstream screening (1/4" or better) is paramount for effective operation of high rate clarification and therefore the PS1 headworks upgrades must occur prior to the installation of HRC unless a dedicated screening system is provided ahead of the HRC. Alternatively, a new PS3 could be constructed to deliver wet weather flow to the new high rate clarification system which would allow for the design of the new pumping station to accommodate the headloss of the new process.

7.5.4.3 Ongoing Asset Management

Since both the existing rectangular and circular primary clarifiers will be an integral part of the treatment process for the foreseeable future, it is imperative that GLWA continue to invest in the existing primary clarifiers to maintain them in good working order. This includes moving forward with rehabilitation of the primary clarifier scum removal system, regularly maintaining and replacing as necessary primary collection mechanisms and sludge pumps as they reach their useful life, and maintaining the ancillary equipment associated with these tanks. Consideration should also be given to assessing the integrity concrete in the existing primary clarifiers which is now 80 years old.

7.6 Secondary Treatment

7.6.1 Introduction

The WRRF uses high purity oxygen activated sludge to treat primary effluent up to 930 mgd. Originally three of the four aeration decks used oxygen while one deck used air activated sludge. Now all four decks use oxygen. Primary effluent is pumped to the secondary treatment system using the Intermediate Lift Pumps (ILPs). When originally constructed, oxygen was generated on-site with a cryogenic oxygen generation facility. The oxygen generation facility has since been abandoned and today GLWA purchases high-purity oxygen (HPO) from Praxair who manufactures HPO locally and pipes it to the WRRF. Oxygen is entrained into the mixed liquor with a total of 102 vertical shaft mixers (25 to 150 hp) and mixed liquor is distributed to 25 secondary clarifiers for settling. A portion of the secondary effluent is screened and disinfected for use on site.

Because of the high percentage of infiltration and inflow in the existing collection system, and the use of ferric chloride in the preliminary and primary treatment system, the influent loading to the existing secondary system is very weak and the capacity of the system is driven more by system hydraulics than organic loading. Although the facility achieves excellent effluent quality, the operations of the secondary system is challenging. An increase in influent loads to the secondary system due to the cessation of ferric chloride addition and/or an alternative residuals handling system will not significantly impact recommendations presented herein.

As with most water reclamation facilities, the secondary treatment system accounts for a significant percentage of the overall O&M costs at the WRRF. At GLWA, the purchase of high purity oxygen and the power used for mechanical aeration and ILPs approach \$7 million annually. Overall aeration and secondary treatment operational costs (including personnel, contractual services, utilities, chemicals, repairs and supplies) accounts for about 25% of the total wastewater operations costs.

Efficiencies created in the secondary treatment system, therefore could have significant impact on the overall plant O&M costs.

Key focus areas of this Master Plan with the secondary treatment system include:

- Optimization of power, chemical and oxygen use in the aeration decks
- Ability to optimize the capacity of the secondary system (to reduce primary effluent discharge)
- Improved operability through improved hydraulics through the secondary system
- Investigation of alternatives to oxygen activated sludge
- Optimization of the Screened Final Effluent (SFE) system

7.6.2 Existing Conditions

The secondary treatment system consists of intermediate lift pumps (ILPs nos. 1, 2, 3, 4 and 7), aeration decks 1 through 4 with 102 vertical shaft mixers total, 25 secondary clarifiers and associated return activated sludge (RAS) and waste activated sludge (WAS) pumping, liquid oxygen storage tank and vaporizer and the abandoned cryogenic oxygen generation facility, and the screened final effluent (SFE) system.

Aeration decks 1 and 2 are fed by ILPs 1 and 2. These vertical mixed flow pumps have a capacity of 365 mgd each and draw directly from the Primary Effluent-Activated Sludge (PEAS) Tunnel. Each pump is driven by a 2,500 hp motor with a variable frequency drive (VFD), which were replaced in 2006. Each pump discharges to the first bay of the aeration deck where it is mixed with RAS. Pumps 1 and 2 can serve either Decks 1 or 2. Similarly, Aeration Decks 3 and 4 are fed by ILPs 3 and 4. ILP 7 is a standby pump to the other four ILPs. ILPs 3, 4 and 7 are vertical turbine pumps with a capacity of 350 mgd (with 2,500 hp motors with VFDs replaced in 2001) and also draw directly from the PEAS tunnel.

Each of the four aeration decks are designed for a peak forward flow of 310 mgd plus 65 mgd return activated sludge (RAS) flow with a volume of 17.8 MG each and a sidewater depth of 30-feet. Decks 1 and 2 consist of 10 bays each and Decks 3 and 4 consist of 8 bays each. Flow through the deck follows a serpentine pattern. Tapered aeration is provided with 19 aerators/deck each in decks 1 and 2 ranging from 150 hp to 75 hp and 32 aerators/deck each in decks 3 and 4 ranging from 100 to 25 hp. The total installed horsepower of the ILPs is 12,500 hp and the total installed horsepower of the aerators is 7,850 hp. The plant is typically operated with a constant return sludge rate, a target MLSS of 1,500 to 1,600 mg/L and an SRT of 2.5 days. Typically, 3 of the 4 aeration decks are in service. There is no provision for step feed at this time.

High purity oxygen, piped to the site from Praxair, is introduced to the first bay of each deck and is entrained into the mixed liquor through the surface aerators. Oxygen flow is manually controlled by adjusting the butterfly valve position to maintain a target DO set point and a target pressure in the headspace. In addition, each aeration deck has a vent with a control valve which continuously releases gas at the last bay. The vent valve is manually controlled to meet the target DO range.

There is a 2,000 ton liquid oxygen storage tank (T-400) with vaporizers to convert the liquid to gas and provide a backup in the event of any disruption to the pipeline.

The contract with Praxair includes a rate for use less than 300 ton per day (TPD) and a much higher rate for use above this amount. The price varies with the Consumer Price Index and is adjusted annually. The contractual minimum usage is 90,000 scfh. The annual cost of oxygen is about \$3.4 million.

There are fixed weirs at the downstream end of the aeration tanks and electric operated isolation gate valves. The secondary clarifier inlet valves are set to balance flows to each clarifier and are used to maintain a reasonable submergence for the surface aerator impellers. The water surface elevation is reported to change by 3" to 4" from average to peak flow events. Maintaining adequate submergence of the impeller is critical to oxygen transfer. The aerators perform effectively within a narrow band of no more than 5 or 6 inches and will shut off on high torque in water level gets too high and will have ineffective oxygen transfer into the mixed liquor if the water surface is too low. The manually balancing of the hydraulic grade line within the aeration decks is labor intensive and one of the issues that makes operations so challenging.

The mixed liquor flows by gravity from the aeration decks and is distributed to the 25 secondary clarifiers which are each rated for 40.4 mgd. Flow enters each clarifier, passing through a magnetic flowmeter, and a motor-operated butterfly valve. Typically, 23 of the 25 secondary clarifiers are in service.

Each clarifier has two 2-ft wide inboard effluent launders, with a single V-notch weir on each face of each launder. These launders discharge through multiple outlet channels to a concentric effluent channel surrounding the entire clarifier.

There are four sludge collection arms per clarifier, except B17 which has two. Each arm has eight 8-inch draft tubes. These tubes discharge into a central RAS pipe that discharges directly to a RAS pumping station. Each clarifier has one variable speed vertical wet pit pump for RAS. The flow rate of the RAS pumps is controlled using VFDs and is usually between 6 to 7 mgd per clarifier. When the PEAS flow exceeds 600 mgd, the RAS flow rate is slightly higher. These pumps are manually controlled (not flow paced) to maintain a desired sludge blanket depth range (about 2 feet). Each RAS pump is rated for 12 mgd, but the actual capacity is closer to 9 to 10 mgd due to clogging of the inlet basket strainer. More effective upstream screening will minimize clogging of these basket strainers. Waste activated sludge is removed on a continuous basis from the RAS line and directed to the Complex B gravity thickeners to maintain a target aerobic solids retention time (SRT) of 2 to 4 days. The WAS pumps are no longer used.

Eight screened final effluent (SFE) pumps, located in the SFE Building, pump water from the chlorine contact channel into the SFE distribution system. Four pumps are typically operated at a time, on a rotating schedule, to meet plant-wide SFE demands of 88 MGD average and 124 MGD maximum. Nearly all SFE is used for thickening, dewatering, and incineration processes. A continuously-backwashed strainer (with 1/64th inch screening) is installed on the discharge side of each pump. The strainer does not produce high enough quality water that can be used for carrier water for chlorination and de-chlorination. As a result, carrier water demands (approximately 3 MGD) are currently met with potable water.

7.6.3 Recent and Planned CIP Projects

The following projects were included in the 2020-2024 CIP:

- **CIP No. 212003 Aeration System Improvements**

This ongoing project is nearing completion and included the addition of oxygen baffles on Bay 10 of aeration decks 1 and 2, replacement of influent and RAS piping, isolation gates and valves for aeration decks 3 and 4, replacement of RAS and influent mag meters for ILPs 3, 4 and 7 and replacement of influent gates on aeration decks 1 and 2.

- **CIP No. 212007 Rehabilitation of Secondary Clarifiers**

This future planned project includes the inspection, study and design for refurbishing the secondary clarifiers, specifically concrete and the rake arms. Isolation gate rehabilitation will also be evaluated.

- **CIP No. 212008 Rehabilitation of Intermediate Lift Pumps (ILPS)**

This future planned project assesses the ILPs which have reached their useful life. The study will assess pump sizing to accommodate dry and wet weather operations to maintain the wet weather secondary capacity of 930 mgd while operating efficiently under dry weather events.

7.6.4 Evaluation of Near-Term and Long-Term Upgrades to Secondary Treatment

The evaluation of upgrades to the secondary treatment process includes an assessment of the existing oxygen activated sludge system and means to optimize the existing treatment system, an assessment of alternatives to oxygen activated sludge, conversion of proposed ACTIFLO® system to BioACTIFLO®, and improvements to the screened secondary effluent (SFE) system to assess use of plant effluent for applications currently using potable water.

7.6.4.1 Optimization of Oxygen Activated Sludge System

The calibrated BioWin model developed for the WRRF was used to evaluate means to optimize the existing oxygen activated sludge system. Model influent itineraries were developed to capture the future flows and loads to the WRRF, as well as the expected daily variation in plant input. Eleven secondary treatment train options were evaluated and compared based on their:

- ability to meet current and potential future permit limits;
- total oxygen and chemical demand;
- impacts on primary sludge and waste activated sludge (WAS) production; and
- impacts on secondary treatment capacity and process stability.

The results of the evaluation, detailed in Technical Memorandum 5A, indicate that EBPR consistently offers the dual benefits of reduced ferric consumption and reduced oxygen use. Further, step feed and biologically enhanced high rate clarification (BEHRC) would be suitable for

increasing secondary treatment capacity. In addition, both improved oxygen and hydraulics control will be integral to any secondary treatment improvements.

7.6.4.2 Alternatives to Oxygen Activated Sludge

Although the oxygen activated sludge system has served GLWA well over the years, the Master Planning effort also evaluated alternatives to oxygen activated sludge that may better meet GLWAs needs into the future. The following alternatives to oxygen activated sludge were evaluated: Air Activated Sludge, BioMag®, Granular Sludge and Membrane Bioreactor. The air activated sludge alternatives were compared against oxygen activated sludge based on process experience, reliability, ease of operation, flexibility, ease of maintenance, process footprint, energy efficiency, effluent quality, and relative costs. This comparison assumes EBPR operation for all alternatives. It is recommended that GLWA maintain oxygen activated sludge for secondary treatment for the following reasons:

- All air activated sludge alternatives would require a significant capital investment in additional equipment and management of those assets.
- It is uncertain whether granular sludge or MBR would be feasible from a process (granular sludge) or hydraulic (MBR) perspective.
- Except for MBR, the air activated sludge alternatives do not offer opportunities for decommissioning more than a single aeration deck.
- Operator familiarity with existing system

7.6.4.3 Conversion to BioACTIFLO® system

As a long-term, transformative project, assuming an HRC ACTIFLO® system is implemented for treating high flows, BioActiflo® could be incorporated as a Biologically Enhanced High Rate Clarification (BEHRC) system to achieve secondary effluent quality of the flow bypassing the activated sludge system. The benefits of this, would be either the potential decommissioning of two aeration decks and 12 secondary clarifiers or increasing the capacity of secondary treatment. The system is mechanically intensive so the tradeoff would be a shift in operation and maintenance from known systems to unknown systems. The benefits would be the smaller footprint required to achieve the same level of treatment. Details of this alternative can be found in Technical Memorandum 5A.

7.6.4.4 Screened Final Effluent

The screened final effluent (SFE) quality is not high enough for many uses on-site, most notably, use as carrier water for chlorination and de-chlorination. Filtering the SFE—such as with cloth media filters—would eliminate the cost of purchasing potable water for this use and also continue move the facility in the direction of resource recovery.

For the purpose of this Master Plan, a cloth media filter system was analyzed as a cost-effective, easy to operate system. During design, alternative filtration systems that achieve similar performance could be evaluated. The filtration system could be first designed to provide adequate volume for meeting on-site demand for chlorination and de-chlorination carrier water. A larger system could be considered for additional non-potable uses on-site that require higher-quality

water than screened final effluent, such as seal water. In the long-term, off-site non-potable water uses could also potentially be satisfied with filtered SFE, and a standpipe could be considered for storage of filtered SFE. Design of the system should consider expandability so potential future additional high quality non-potable water demands could be met.

7.6.5 Summary of Secondary Treatment Alternatives

Based on our analysis, oxygen activated sludge system remains the most viable alternative to treat the primary effluent to meet NPDES requirements. There are a number of relatively inexpensive near-term solutions developed to optimize chemical and oxygen addition, reduce power consumption, and improve system hydraulics, resulting in significant cost savings over time. A more significant project, to increase the performance and reliability of the secondary treatment system to accept 930 mgd or more by incorporating step feed into the system could be implemented concurrently with the near-term modifications, to bring the entire secondary system to a point where it is renewed for long-term operation. Beyond that, if high rate clarification with ACTIFLO® is implemented for high-flow management, this system could be converted to a biologically enhanced high rate clarification system to further improve the quality of the effluent that bypasses the oxygen activated sludge system. The following projects are recommended in the near-term:

- Modifications to Aeration Decks 1 and 2
- Modifications to Aeration Decks 3 and 4
- Screened Final Effluent (SFE) Treatment and Storage

In addition, a discussion of required on-going asset management through the 40-year Master Planning horizon is presented.

7.6.5.1 Modifications to Aeration Decks 1 & 2

In general, the secondary treatment system is under-loaded and operates with three of the four trains in service. The system achieves some level of biological phosphorus removal, by turning off mixer aerators in the first bay, but this can be improved as described below. Ferric chloride optimization was discussed in the previous section, however once biological phosphorus removal is implemented it is likely that ferric chloride addition could be further optimized. Modifications to the solids handling system which may increase sidestream loadings are not expected to impact the recommendations presented herein, but should be reassessed during design.

Recommended improvements to Aeration Decks 1 & 2 are summarized in Figure 7-10 and detailed in Technical Memorandum 5A and include:

- Conversion of the first three of ten bays in each deck to anaerobic zones to promote EBPR,
- Implementation of step feed capability by enabling the discharge of primary effluent to flow to not only the first bay in each deck, but also bays 3, 5 and 6 (or alternatively 4 and 6).
- Improving deck hydraulic management to maintain the WSE within the allowable 6-inch band for the mixers in Bays 4 through 10 by increasing the effluent weir length to 450 ft and raising the weir elevation.

- Improve oxygen control by installing new instrumentation and controls and updating the control logic in the Ovation system.
- Consideration to replace the aerators in Bay 4 with hyperbolic mixer/aerators should also be investigated during design as a means to more efficiently transfer oxygen. Since there is limited experience with the mixer/aerator with pure oxygen systems, this could be piloted with one unit on Train 1 before moving forward with all units.

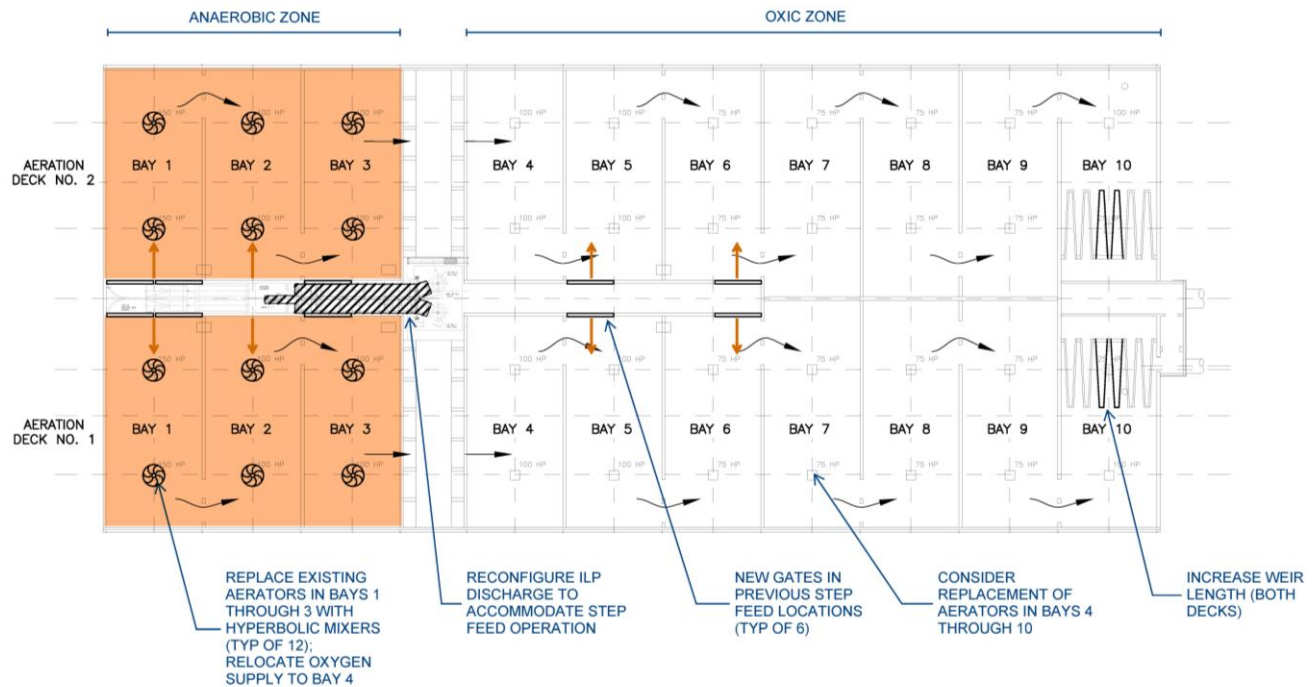

Figure 7-10. Recommended Improvements to Aeration Decks 1 and 2

To get the most value in the investment, these improvements should be designed and constructed in concert with one another since the improvements are intricately related and need to be designed and constructed with the **system** in mind. For instance, replacement of the ILPs needs to happen in concert with step feed to ensure adequate pumping capacity, but also together with modifications to weir elevations. Modification to weir length and elevation needs to be done with the mixer aerator assessment to ensure the mixers are set and operated within the appropriate band. And EBPR should be coordinated with oxygen control improvements since control locations will adjust with EBPR. In addition, during upgrades the condition of the concrete should be assessed and leakage in the tanks identified and repaired so tanks and equipment are completely rehabilitated at the completion of the project.

The recommended improvements for Aeration Decks 1 and 2 will positively impact the following planning performance measures:

- kWh/MG treated and kWh/lb BOD removed: replacing the mixers in Bays 1 through 3 with hyperboloid mixers would decrease the overall installed horsepower of the mixers in Decks 1 and 2 by 1,135 HP.
- Volume of chemicals used annually: by implementing EBPR and decreasing reliance on ferric chloride for phosphorus removal, approximately 900 to 2,700 gpd would be saved, or about 15 to 40% less than without EBPR (for all decks).
- Volume of oxygen used annually due to: (1) increased oxygen utilization and (2) the fact that some of the primary effluent BOD will be oxidized anaerobically before the oxic zones. The estimated oxygen savings due to the second factor alone is approximately 10%, whereas estimated oxygen savings from the first factor could be 20 to 30% or more.
- Annual number and volume of primary effluent discharges by incorporating step feed: by incorporating step feed, primary effluent discharge volume would be expected to decrease from an estimated 3,650 MG/year (average based on 2014 through 2017 data) to 2,600 MG/year.
- A more stable biological phosphorus removal system that will maintain or reduce the mass loading of phosphorus discharged.

It is expected that the return on investment of the improvements, exclusive of the step-feed modifications, would be on the order of 5 to 10 years. These improvements will have a net positive impact on the cost performance measures (e.g., unit cost per MG treated, chemical use, oxygen use and power demand).

Challenges associated with the Deck 1 and 2 improvements include:

- Increased reliance on automation for DO control, which will require ongoing maintenance and calibration of the DO probes and other instruments (gas flow meter, vent purity analyzer), as well as sufficient operator comfort level with the control scheme;
- Finding the right balance between ferric chloride addition ahead of primary treatment to maintain 1.5 mg/L TP in primary effluent, but maximizing the use of EBPR in the aeration decks for phosphorus removal;
- Establishing an optimal, effective strategy for converting from plug-flow operation to step-feed operation during high-flow events; and
- Maintaining some level of flow measurement into each aeration deck.
- Balancing hydraulics between upgraded aeration decks 1 and 2 and existing aeration decks 3 and 4, as well as the modified mind-set of hydraulic control in thru the secondary system.

Since the plant typically operates with one aeration deck out of service, maintenance of plant operation during construction is simplified. However, the construction sequence must be coordinated to maintain secondary treatment capacity during construction.

7.6.5.2 Modifications to Aeration Decks 3 & 4

Similar to decks 1 and 2, decks 3 and 4 would be optimized with respect to hydraulics, oxygen utilization, capacity, and biological phosphorus removal by implementing the improvements outlined below.

The recommended improvements to Aeration Decks 3 & 4 are similar to the improvements recommended for Decks 1 and 2:

- Conversion of the first two bays in each deck to anaerobic zones to promote EBPR,
- Implementation of step feed capability by enabling primary effluent to be discharged to bay 3 and 5,
- Improving deck hydraulic management to maintain the WSE within the allowable 6-inch band for the mixers in Bays 3 through 8 by raising the weir elevation,
- Improve oxygen control by installing new instrumentation and controls and modifying the control logic.

The recommended improvements for Aeration Decks 3 and 4 will positively impact the same planning performance measures as outlined above for decks 1 & 2, and also have a net positive impact on the cost performance measures (e.g., unit cost per MG treated, chemical use, oxygen use and power demand). Challenges associated with the implementation of Deck 3 and 4 improvements are also similar to those presented for decks 1 & 2.

As with Decks 1 & 2, ideally, all improvements to Aeration Decks 3 and 4 would be made concurrently to realize the benefits of more efficient oxygen control and hydraulics, as well as increased flexibility in operation. Further, it is anticipated that the improvements to Aeration Decks 3 and 4 would be completed after the improvements to Decks 1 and 2 are completed and operated for at least two years. Performance in Decks 1 and 2 after implementation of the improvements can then be used to inform the Decks 3 and 4 upgrades.

7.6.5.3 Screened Final Effluent (SFE) Treatment and Storage

As discussed, GLWA purchases potable water from the City of Detroit for non-potable uses on-site, where the quality of SFE does not meet the requirements of the use (specifically with respect to total suspended solids). One such use is as carrier water for chlorination and dichlorination. Potable water is purchased for this use at a cost of about \$3.7M per year. The recommended SFE improvements focus on treating SFE via filtration to offset the potable water demand for disinfection and dechlorination, but also could provide better quality SFE for other current and potential future uses around the site.

The recommended improvements to allow use of reclaimed SFE to meet the demand for high-quality carrier water for chlorination and dechlorination are:

- Installation of two (one duty/one standby) cloth media filtration trains, each with 16 disks of 5-micron pile cloth media and one dedicated filter backwash pump per train, sized for 2,100 gpm. Alternatively, it could be assumed that redundancy is provided with the City water

connection and only one train provided, or two trains with eight disks each to allow expandability while also providing some level of redundancy.

- Construction of a new 1,000 ft² SFE filtration building to house the filter trains and associated process equipment.
- Erection of a filtered SFE storage tank to store treated SFE. This tank could be sized to accommodate future reclaimed water demand, or could be sized to store one day of carrier water demands (e.g., 3 MG).

The system should be designed for expansion with additional trains to move towards expanded reuse opportunities on-site and potentially off-site. Note alternative filtration technologies could be assessed during design. Cloth media filtration was selected in Master Planning as one potential cost-effective, easy to operate solution.

The recommended improvements for SFE filtration will decrease the volume of potable water used each year by approximately 2.7 MG. SFE filtration will also set the WRRF on a path forward toward the use of reclaimed water for additional potable water demands on-site and off-site and provide a level of self-sufficiency in water supply that doesn't exist today.

The challenges associated with this improvement include:

- Operation and maintenance of additional assets on-site;
- Siting of the new facility and distribution of filtered SFE throughout the site;
- The impact on water production revenue from the reduced consumption in city water.

Because of the estimated return on investment of the proposed filtration system, as well as the current need to upgrade the SFE pumping system, it is proposed that this system be implemented in the near-term. Sizing of the system should consider the increase in SFE associated with the new RRO project, the proposed upgraded grit and screening facilities, modifications to the residuals handling facilities, other on-site needs, and the potential expansion of the system to accommodate potential off-site use in the future.

7.6.5.4 Ongoing Asset Management

In addition to the secondary improvements outlined above, there are opportunities for improved energy and operational efficiencies elsewhere in the secondary treatment process as part of ongoing asset management.

Recommended ongoing asset management for the secondary treatment system would include maintenance of the secondary clarifiers and associated sludge and scum collection; rehabilitation, as needed, of the RAS pumps; rehabilitation of the SFE pumps; and replacement of aerators in the oxic zones for all aeration decks. The replacement of aerators in the oxic zones for all aeration decks is discussed below.

The aerators currently installed in Bays 4 through 10 of Decks 1 and 2 have a combined motor HP of 4,300 HP. Replacement of the existing aerators with higher-efficiency equipment could reduce

installed HP from 4,300 HP to 2,220 HP. Similarly, the aerators currently installed in Bays 3 through 8 of Decks 3 and 4 have a combined motor HP of 2,900 HP which could be reduced to 1,400 HP. This will decrease the kWh/MG treated as well as the kWh/lb BOD treated. Note that this project assumes the first three bays (Decks 1 and 2) and first two bays (Decks 3 and 4) have already been converted to anaerobic zones.

Replacement of the oxic zone aerators could be coordinated with the other recommended improvements in the aeration decks (conversion to anaerobic zones and step feed etc.). Alternatively, aerators could be replaced on an as-needed basis when the existing equipment reaches the end of its useful life.

7.7 Disinfection

7.7.1 Introduction

The WRRF uses gaseous chlorine to produce a chlorine solution that is used as the disinfectant for the secondary clarifier effluent. Gaseous sulfur dioxide is used to produce a solution that removes the total residual chlorine (TRC) from the effluent prior to discharge. Originally, the gaseous chlorine tank cars were unloaded at the WRRF site, and chemical was piped to the junction chamber 1 (JC-1) for injection. When regulations concerning the handling and management of these chemicals was instituted, a new chlorination and dechlorination facility was constructed in the late 1990s on the Detroit Marine Terminal site. This facility location is remote from the rest of the WRRF operations and was constructed to include important safety features to prevent the release of chlorine or sulfur dioxide gas from leaks during unloading operations. GLWA currently maintains HAZMAT staff nearby as an additional safety precaution for this facility.

The regulations are stringent for chlorine gas storage and transportation because of its explosive and toxic nature. Gaseous chlorine is regulated as an Extremely Hazardous Substance under Section 112R of the Clean Air Act at a threshold of 2,500 pounds. The threshold under the Emergency Planning and Community Right-to-Know Act (EPCRA) is 100 pounds and the release-reporting threshold under CECRLA is 10 pounds. Many water and wastewater treatment plants have been converting to sodium hypochlorite or other disinfectants after consideration of the hazards, risks to the community from an accidental release, and costs of the regulatory burden associated with chlorine gas.

Although the use of chlorine gas for a facility this size is cost-effective, the risk of storage and handling chlorine gas on-site warrants an evaluation of alternative disinfectants for long-term operations.

As a part of the recent Rouge River Outfall (RRO) disinfection project, described below, alternative disinfectants were reviewed and, at that time, sodium hypochlorite was selected as the preferred disinfectant and sodium bisulfite for dechlorination given GLWA's desire to move away from reliance on chlorine gas and sulfur dioxide, and the schedule constraints of the project.

From a Master Planning standpoint, the following challenges are addressed in this section:

- Desire to ultimately eliminate the use of chlorine gas
- More efficient use of water and chemicals in current operation

7.7.2 Existing Conditions

The existing gas chlorine facility includes a total of 16 chlorine gas chlorinators and 16 evaporators to convert gas chlorine to liquid. The capacity of each unit is 10,000 lb/day with total capacity up to 160,000 lb/day. This system was designed assuming the entire flow would ultimately be disinfected with gaseous chlorine. Since the current annual chlorine usage averages 9,300 lb/day, the current system is oversized. The facility uses potable water to both generate the chlorine solution and to provide the motive force to convey the solution to the application point. The annual potable water usage is estimated at approximately 3 mgd, which is a significant cost to the annual operations of this facility. The use of screened final effluent (SFE) as the carrier water was presented in the previous section.

The existing dechlorination facility has 14 sulfonators and evaporators. The capacity of each unit is 9,500 lb/day/unit with total capacity up to 133,000 lb/day. Similar to the chlorine feed equipment, this system is oversized, based on current usage. Sulfur dioxide is fed to the effluent flow near the outlet of the DRO to reduce the chlorine residual to less than 0.11 mg/L. Total Residual Chlorine (TRC) analyzers in Sampling Building 2 (located 200 feet downstream of the sulfur dioxide diffuser on Zug Island) measure chlorine residual concentration in the dechlorinated effluent and can control the sulfonators.

7.7.3 Recent and Planned CIP Projects

- **GLWA Project PC-797 – Rouge River Outfall Disinfection**

This recently completed project (start-up spring 2019) constructed a disinfection facility for storing and feeding sodium hypochlorite and sodium bisulfite to the wet weather primary effluent discharge. Primary effluent discharges under wet weather conditions, heretofore, had not been disinfected. This project also relocated the gaseous chlorine injection point from JC-1 to the new diffuser injection point for secondary effluent, near the SFE pumping station. A hypochlorite feed pipe was also constructed from the RRO hypo facility to a new diffuser injection point located near the MD-3, 4 control gates. Both of these diffuser locations include new flow meters to control the application of chemical.

Sodium hypochlorite is delivered to the RRO disinfection facility via tanker truck and stored on-site in three 110,000-gallon sodium hypochlorite storage tanks. Sodium hypochlorite is delivered to the site as a 15% solution and diluted to an 8% solution to provide a more stable solution that will degrade more slowly when stored. Sodium bisulfite is also delivered to the WRRF via tanker truck similar to the hypochlorite system. There are two 34,500-gallon sodium bisulfite bulk storage tanks.

- **CIP Number 212004: Chlorination and Dechlorination Process Equipment Improvements**

Currently a project is underway to rehabilitate the evaporators, chlorinators, sulfonators and valves and appurtenances constructed in the late 1990s which have deteriorated due to the corrosive nature of the chemicals utilized. This project is expected to be complete in FY2021 and will maintain the safety of the system as well as regulatory compliance. All 16 of the chlorinators and 10 of the sulfunators were slated to be rehabilitated. However, subsequent

to our planning meeting on the topic the scope of the chlorinator and sulfunator rehabilitation was scaled back to better match current need and ensure value of investment by reducing the number of assets requiring maintenance overtime.

- **CIP No. 216008: Rehabilitation of Screened Final Effluent (SFE)**

This future project includes the study, design and construction of needed improvements to the SFE pump station. The project includes rehabilitation of the pumps, strainers, piping, controls as well as building improvements and improvements to the electrical supply. The study will also evaluate the potential for replacing the potable water utilization with SFE where feasible, including an alternatives analysis to the existing carrier water at the chlorination/dechlorinate facility, and for seal water. Additional SFE treatment to accommodate process needs and/or the construction of an elevated SFE storage tank to maintain pressure in the system will also be evaluated.

7.7.4 Evaluation of Near-Term and Long-Term Upgrades to Disinfection

In order to reduce the risk of the storage of chlorine gas on-site, a number of conventional and emerging disinfectants were analyzed for use in disinfecting GLWA's dry weather flow, currently dependent on chlorine gas. Disinfectants reviewed included chlorine dioxide, peracetic acid (PAA), sodium hypochlorite, ozone and ultraviolet disinfection (UV). Chlorine dioxide was eliminated from the evaluation due to limited experience in wastewater, the complexity of the operation and maintenance of the required on-site generation system and the high chemical cost. Although gaining popularity as a wastewater disinfectant, PAA was also eliminated from the evaluation. Testing of PAA previously performed at GLWA concluded that high disinfection doses were required when compared to chlorine which made it cost prohibitive. Sodium hypochlorite, ozone and UV disinfection were carried forward for a more detailed evaluation.

7.7.5 Summary of Disinfection Alternatives

At the completion of the Master Plan, the disinfection facilities will be amongst the most updated unit processes at the WRRF as a result of the ongoing rehabilitation the existing chlorine gas and sulfur dioxide systems, and the startup of the RRO disinfection project in the Spring of 2019. The impetus for change in these systems result from the desire to ultimately eliminate the use of gaseous chlorine for safety reasons. As a result, the recommended alternative at the disinfection facilities in the near-term focuses on eliminating the gaseous disinfection feed systems and replacing with sodium hypochlorite, and in the long-term looks at alternative disinfectants as the existing disinfection systems approach their end of life.

Based on the analysis, the following planning options are recommended moving forward:

- Evaluation of the use of sodium hypochlorite for the full treatment plant flow
- Evaluation of alternative disinfectants

7.7.5.1 Sodium Hypochlorite for Full Flow (Elimination of Gaseous Chlorine)

The RRO disinfection facility included the ability for sodium hypochlorite to be injected into the secondary effluent flow in the event the chlorine gas system is unavailable. Given the safety and security risks associated with maintaining a large supply of chlorine and sulfur dioxide gas on-site,

it is recommended GLWA evaluate the feasibility of operating the RRO disinfection facility continuously to disinfect both secondary effluent and primary effluent discharged.

Currently, 15% sodium hypochlorite is delivered to the RRO facility and then diluted down to 8% to increase the shelf life of the chemical. Based on assumed dosages, using an 8% solution, design calculations indicate there is insufficient storage volume to disinfect both the secondary effluent on a continuous basis and the primary effluent during bypass events. However, if the sodium hypochlorite was dosed at full strength (15%), calculations reveal, the three existing hypochlorite storage tanks at the RRO facility would be sufficient to disinfect both the secondary effluent continuously and the primary effluent during a bypass event. The consequence of this operational strategy is the hypochlorite degrades much quicker at higher concentrations so effective disinfection depends on adjusting dosage based on the hypochlorite concentration at any given time.

In order to confirm the calculations above, GLWA should immediately begin collecting, tracking and maintaining a database of sodium hypochlorite and sodium bisulfite use for the new system over the next three to five years. Information collected would include the frequency and duration of wet weather discharges (secondary treatment bypass), the sodium hypochlorite concentration, the dosage of sodium hypochlorite and sodium bisulfite required to meet effluent limits, and the frequency of chemical deliveries. Cost of chemicals should also be tracked, as well as the rate of hypochlorite degradation in strength over time. With this information, a more accurate assessment of the site-specific dosing requirements and thus the available storage volume for primary effluent discharges can be performed and seasonality of hypochlorite usage can also be evaluated.

With this information in hand, GLWA can then select an appropriate time-frame to pilot test chlorination of the secondary effluent with sodium hypochlorite. This could first be assessed using an 8% solution to determine site specific dosage, and then be modified to determine required dosage at varying sodium hypochlorite concentrations. The objective of the pilot testing would be to determine the lowest concentration of hypochlorite that could be stored at the RRO facility, while avoiding the need to add a fourth sodium hypochlorite tank which would require an expansion of the RRO disinfection facility. **This chemical feed strategy could be a perfect opportunity to evaluate and implement real-time monitoring and control and machine learning to optimize chemical use.**

A secondary study that should be considered, once chlorine dosages for both the primary effluent and secondary effluent are established, is an assessment of the feasibility and appetite of a chemical supplier to construct a sodium hypochlorite generation facility in close proximity to the plant site. In this case, sodium hypochlorite would be piped directly to the site (similar to the Praxair oxygen feed contract), thus significantly reducing the required on-site storage of sodium hypochlorite. This could also mitigate concerns voiced by operators in the region that during storm events, the numerous treatment facilities and RTBs have difficulty receiving deliveries in a timely fashion due to a shortage of truck drivers.

Eliminating the gaseous sulfur dioxide feed system would require additional liquid sodium bisulfite storage on site. No provisions were included within the RRO disinfection facility for this additional tankage. If the pilot testing of hypochlorite for the full WRRF flows is successful and gaseous

chlorine is phased out the existing chlorine gas feed facility could be retrofit with a sodium bisulfite feed system to replace the existing sulfur dioxide system.

The benefit of changing the disinfectant from chlorine gas to sodium hypochlorite would be elimination of the use of a dangerous gas at the WRRF which would provide a more inherently safe disinfection system to GLWA operations staff and the utility as a whole. Eliminating the use of gaseous chlorine would also eliminate the need for the hazardous material response team on-site.

If a chemical supplier was to site a sodium hypochlorite generation facility in close proximity to the WRRF, truck traffic to the site, for the delivery of sodium hypochlorite, would decrease. In addition, the generation facility could also serve other proximate GLWA facilities potentially reducing the unit cost for sodium hypochlorite system wide.

It is assumed that the data collection and pilot testing of sodium hypochlorite use for secondary treated effluent could be led by GLWA's Energy, Research and Innovation group with the assistance of a consultant, if need be, to coordinate testing protocol, assist with vendor communications related to off-site hypochlorite generation, and develop costs for any new infrastructure required.

The results of the pilot testing will dictate the ultimate cost of implementation which could range from essentially no capital cost to the cost of adding additional chemical storage and feed facilities for both sodium hypochlorite and sodium bisulfite. If the pilot testing demonstrates a lower design dose than what was estimated in the RRO design, the existing storage capacity may be sufficient. Based on the assumptions included, the estimated annual O&M cost for gaseous chlorine versus sodium hypochlorite is essentially equal. Although gaseous chlorine is a less expensive chemical, a large component of the O&M for the gaseous system is for additional operator maintenance and on-call HAZMAT team.

The future assessment of full-scale sodium hypochlorite use versus continuation of the use of gaseous chlorine should be coordinated with the assessment of and use of filtered SFE in lieu of potable water for these systems.

7.7.5.2 Alternative Disinfectants

The removal of chlorine and sulfur dioxide gas from the WRRF and replacement with sodium hypochlorite and sodium bisulfite would result in an inherently safer overall disinfection facility. However, disinfection of treated effluent with chlorine, regardless of the form, still has a higher probability of producing disinfection by-products (DBPs), such as halo acetic acid or trihalomethanes. As a result, a transformative change to the disinfection process should be further evaluated circa 2035 when it is likely that another significant rehabilitation of the existing chlorine feed facilities would be required.

As the RRO disinfection facility approaches its useful life it is recommended a Disinfection Facility Plan be initiated to assess the disinfection process at the WRRF. The purpose of this work will be to assess the change in environmental regulations and permit drivers that may push the WRRF toward a transformative disinfection technology that minimizes DBPs or perhaps even provides a higher quality of treatment for items such as bacteriophage, pharmaceuticals, endocrine disruptors, etc. The cost-benefit of alternative systems could be better analyzed at that time. As presented in Technical Memorandum 5A, the current analysis, is pointing to either UV disinfection or ozone,

however, in 15 to 20 years the disinfection industry may have evolved further, costs shifted, and/or treatment plant effluent changed which could all impact the results of the analysis. Currently, investigations of hybrid disinfection systems which include both ultraviolet disinfection in combination with a chemical disinfectant are gaining in popularity to provide a broader range of disinfectant capabilities. As GLWA moves forward in analysis, it is recommended that this too be assessed.

The benefits of implementing a transformative disinfection alternative such as ozone or UV would result in lower DBPs and more autonomous disinfection processes, which would have the ability to adjust dosage automatically to deliver the optimum disinfection dose. The challenge with both of these disinfection processes would be fitting them into the existing footprint at the WRRF. Based on current technology, it is assumed a UV systems would be reserved solely for disinfection of dry-weather flow discharges from the WRRF. Providing a UV design to treat the maximum dry weather flow of 930 mgd would be a challenge. Currently the largest wastewater UV system is rated for 450 mgd. There is a location upstream of the SFE pumping station that seems best suited for a UV system. Any concept to fit a UV system at the WRRF would require an extensive hydraulic analysis with CFD modeling and potentially scale models of the system to confirm the approach and exit velocities into and through the UV channels as well as flow split, and ability to maintain a gravity discharge to the rivers within the range of expected river elevations at the time. Under this scenario it is assumed that a chemical disinfectant would be utilized for disinfection of wet-weather flows.

The evaluation of ozone would require at a minimum a bench scale test to determine the ozone demand for a system at the WRRF. For the purposes of this Master Plan, an ozone dose was assumed to provide a level of magnitude cost for an ozone system. A key benefit of utilizing ozone is that there's an existing liquid oxygen line at the WRRF already for the existing biological treatment process. As the planning for this transformative disinfection evaluation is set to begin, this is an item that would want to be reviewed closely as the liquid oxygen line has the potential to greatly reduce the O&M of this system.

Since the implementation of these alternatives is up to 20 years in the future, it is proposed that in 2035 GLWA's Research and Innovation group begin to collect data related to UV transmissivity of the secondary effluent as well as testing of the treatability of the effluent with ozone. This data collection will serve to better inform the design criteria to be used to develop capital and O&M costs for the alternative systems as compared to upgrading the existing disinfection system.

For the purposes of this analysis, it is assumed that the implementation of either of these facilities would require construction within the WRRF's existing constrictive footprint. The most difficult aspect of this would be the maintenance of plant operations while the new facility was being constructed. These are all scenarios that would need to be further evaluated as additional data is collected to better define the design criteria for each of the alternatives. Alternatively, investigation of these alternatives could consider use of existing GLWA owned parcels outside of the fence line and/or acquisition of land outside the fence.

7.8 Biosolids Processes

7.8.1 Introduction

The biosolids process train includes sludge thickening, dewatering, drying, incineration and lime addition processes and related equipment. Primary sludge and waste activated sludge (WAS) are thickened separately using gravity thickeners. Thickened primary sludge (TPS) and thickened WAS (TWAS) is pumped separately and blended in a pipe before being sent to three sets of two sludge storage tanks (SST). From the SST, sludge is sent to one of three different dewatering complexes using either belt filter presses or centrifuges and then dewatered solids are sent to either Complex II Incineration or the Central Off-Load Facility (COF) which provides lime stabilization of dewatered biosolids. Alternatively, mixed thickened sludge is sent directly from the SST to the recently constructed Biosolids Drying Facility for dewatering and pellet production.

As required by the NPDES permit – the sludge processing systems have the combined capacity to process 850 dtpd. The three treatment trains provide flexibility in the type of end product generated (e.g. pellets, ash or cake), and offer risk management in the event of a significant system failure in one of these areas or challenges with the disposal of a certain type of product. The diversity in sludge processing equipment, however, also comes at a cost to operate and maintain multiple processes and associated ancillary systems.

From a holistic Master Planning stand point the following items were identified as potential drivers for change into the future:

- The long-term integrity of the incinerators and the high cost to operate in a standby mode,
- Desire for additional resource recovery (i.e., energy, phosphorus),
- Goal to reduce greenhouse gases (GHG),
- Capacity limitations on the existing drying facility, and
- The potential for more restrictive regulations in the future associated with land application and air emissions

7.8.2 Existing Conditions

7.8.2.1 Thickening

Two gravity thickener complexes exist – one for primary sludge, Complex A and one for WAS, Complex B.

Complex A – Primary Sludge Thickening

Complex A consists of six 105-ft diameter gravity thickeners. Each thickener has a center driven rake mechanism to convey the thickened sludge to the draw-off point at the bottom of the thickener. Recessed impeller pumps transfer the sludge to inline blending with thickened WAS (TWAS) upstream of the sludge storage tanks. One pump per thickener runs continuously and the speed of each pump is adjusted manually to maintain a sludge blanket range.

Screened final effluent (SFE) is pumped continuously to prevent odors and septicity with a target of up to 0.5 to 1.0 mgd per thickener.

Complex B – WAS Thickening

Complex B also consists of six 105-ft diameter gravity thickeners. Each thickener has a center driven rake mechanism to convey the thickened sludge to the draw-off point at the bottom of the thickener. Recessed impeller pumps transfer the TWAS to inline blending with thickened primary sludge (TPS) upstream of the sludge storage tanks. One pump per thickener runs continuously and the speed of each pump is adjusted manually to maintain a sludge blanket range.

Screened final effluent (SFE) is pumped continuously to prevent odors and septicity with a target of up to 0.5 to 1.0 mgd per thickener.

The firm capacity of each, based on solids loading is shown in Table 7-9.

Table 7-9. Gravity Thickener Equipment Capacity Summary

Location	Type of Equipment	Total Quantity	Unit Capacity (dtpd)	Quantity Available (Firm)	Firm Capacity (dtpd)
Complex A	Gravity Thickener	6	129.9	5	649
Complex B	Gravity Thickener	6	34.6	5	173
TOTAL					823

When analyzing the gravity thickener capacity the available sludge storage capacity in the thickeners is included increasing the available capacity to 850 dtpd for Complex A and 250 dtpd for Complex B.

7.8.2.2 Sludge Storage

There are six sludge storage tanks, located next to Complex A thickeners, providing equalization between thickening and dewatering. Details on each are presented in Table 7-10.

Table 7-10. Sludge Storage Tank Details

Tank No.	Shape	Volume (gallons)	Use/Feed
1 & 2	Circular	212,000	Complex II Belt Filter Presses (BFPs)
3 & 4	Circular	212,000	Complex I Centrifuges OR Biosolids Drying Facility Centrifuges
5 & 6	Rectangular	230,000	Complex I BFPs

A combination of recessed impeller, centrifugal and chopper type pumps deliver sludge from the storage tanks to the downstream process. Figure 7-11 shows a simplified schematic of the solids handling system.

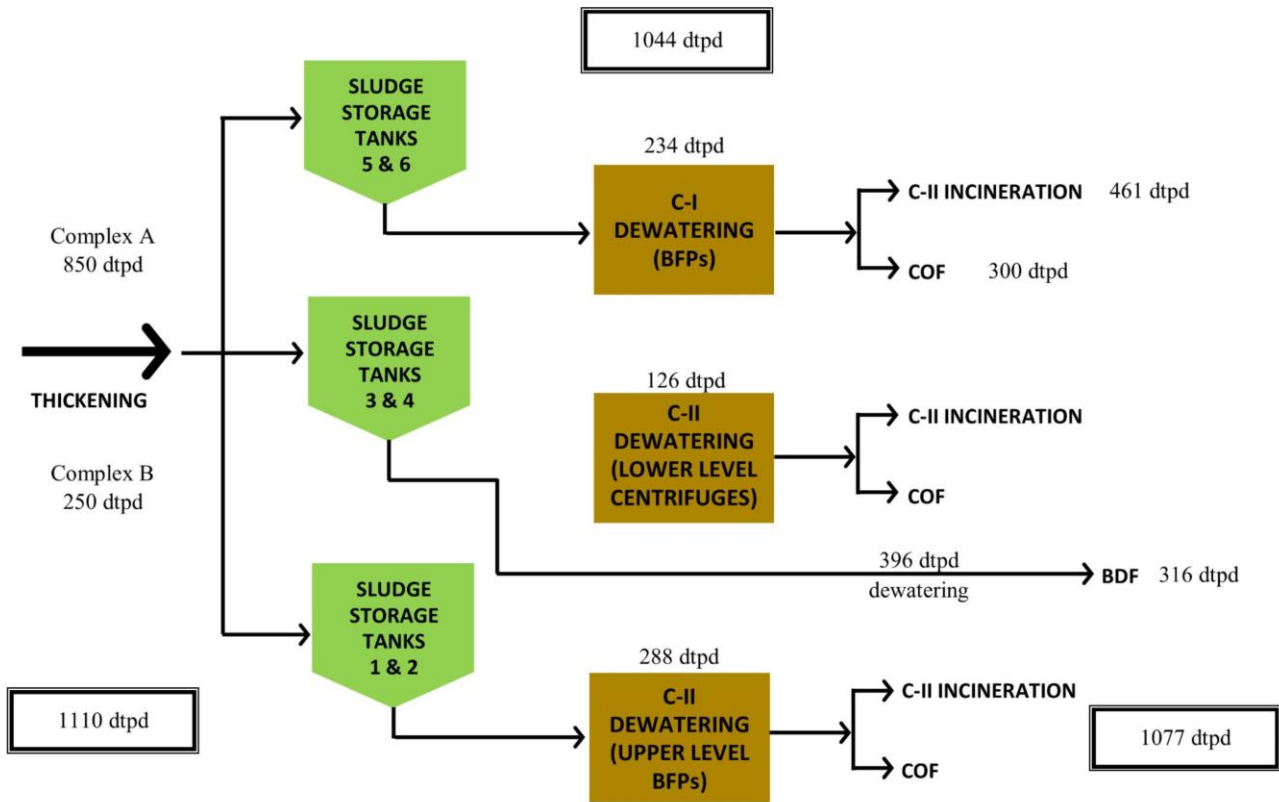

Figure 7-11. Simple Schematic of Solids Handling

7.8.2.3 Dewatering

GLWA can dewater sludge with up to five different types of equipment as presented in Table 7-11. The eight Westfalia centrifuges have been problematic from excessive grit wear and are not used.

Table 7-11. Dewatering Equipment and Capacity Summary

Location	Type of Equipment	Total Quantity	Manufacturer	Capacity	Quantity Available (Firm)	Firm Capacity (dtpd)
Complex I	BFP	10	Alfa Laval Ashbrook Simon-Hartley	150 gpm @ 4% 36 dtpd	6.5	234
Complex II – Upper Level	BFP	12	Alfa Laval Ashbrook Simon-Hartley	150 gpm @ 4% 36 dtpd	8	288
Complex II – Lower Level	Centrifuge	8	Westfalia	190 gpm @ 4% 42 dtpd	0	0
Complex II – Lower Level	Centrifuge	4	Sharples	175 gpm @ 4% 42 dtpd	3	126

Location	Type of Equipment	Total Quantity	Manufacturer	Capacity	Quantity Available (Firm)	Firm Capacity (dtpd)
Biosolids Drying Facility	Centrifuge	8	Alfa Laval	183 to 440 gpm @ 2.5% to 6% 66 dtpd	6	396
TOTAL						1,045

7.8.2.4 Incineration

The Complex I incinerators were constructed in 1940 and include six, 11 hearth units with capacity of 10 wet tons/hr. These were decommissioned in early 2017.

Complex II Incineration were constructed in the 1970s and consists of eight multiple hearth incinerators each with 12 hearths. The rated capacity of each is 3.2 dry tons per hour (dtpd). The firm C-II Incineration capacity is 461 dtpd based on six of eight incinerators in service and a 25 percent feed cake total solids concentration. Natural gas is used in the incineration process.

Induced draft fans are used to draw air through the incinerator, air pollution control equipment, and discharge the air to atmosphere through one of three stacks. The air pollution control equipment is used to cool and remove particulates and gaseous pollutants from the exhaust gas. The exhaust gas oxygen level is monitored at the scrubber system inlet. The opacity and total hydrocarbon (THC) concentrations are monitored at the discharge of the scrubber system. The bypass exhaust stack is used when the incinerator is on standby or out of service.

The inert ash is discharged from the incinerator into a dry ash hopper equipped with a crusher. From the ash hopper, one of two ash handling systems is utilized: a dry ash vacuum conveying system or a wet ash system. Ash is trucked to landfill.

It is expected that recent and ongoing improvements to the Complex II incinerators make these units viable through 2035 assuming current air emissions regulations don't change.

7.8.2.5 Drying

The Biosolids Drying Facility (BDF) is operated and maintained by the New England Fertilizer Company (NEFCO) under a 20-year contract. It went into operation in August 2015 and was given Beneficial Use in mid-February 2016. The contract includes a guaranteed daily minimum volume received from GLWA of 184 dtpd. GLWA owns the dryer facility which was designed for a firm capacity of 316 dtpd (with 3 of 4 trains in service, each rated for 105.4 dtpd).

Unstabilized sludge is fed directly from the sludge storage tanks to the BDF, where flow proceeds to eight centrifuges for dewatering. Cake solids from the centrifuges typically averages 29 to 30 percent solids. From each pair of centrifuges, cake drops into a cake bin, a twin-screw feeder and inclined belt conveyor where recycled finished product mixes in a pug mill. This raw cake and recycled pellet mix is fed to one of four triple-pass rotary drum dryers by a screw conveyor.

The dried biosolids exits the dryer and is vertically conveyed pneumatically, together with process air to a cyclone separator. The separated pellets then drop through a rotary air lock and into the screener which separates the pellets by size into four fractions:

- Coarse trash material is screened out and is hauled off site for landfill disposal (approximately 1% of finished product).
- Oversized material drops into a crusher to be reduced in size and drop into the recycle bin.
- Fine material passing through the screens drops into the recycle bin along with the crushed oversized pellets is reintroduced to the system in the pug mill mixer where fines and crushed overs are formed into pellets again.
- Properly sized material drops into the pellet cooler.

Finished product is stored within four bolted steel silos. The Class A finished product is land applied or sent to a landfill. Currently most of the product is sent to Canada for reuse.

Natural gas provides the heat necessary to evaporate moisture from the biosolids mix. The dryer inlet gas temperature typically varies between 700-1000°F, depending on processing rate. The tempered, hot gas dries the sludge in the drum and provides the motive force to propel the solids through the dryer. The spent, cooled gases, solids and evaporated water exit the drum, are carried up in a vertical duct to the separator where solids are separated from the gases. The exhaust gases are first treated in a tray scrubber to remove the remaining solids and to remove water vapor. Most of this cleaned, dehumidified gas is returned to the inlet of the dryer and is used as tempering air within the dryer. The excess gas is drawn through a fan and ducted to a Regenerative Thermal Oxidizer (RTO). The RTO destroys odor causing compounds, carbon monoxide and organic vapors by heating the gas to about 1500°F. The volatile organic compounds are oxidized to carbon dioxide and are discharged to the atmosphere. Most of the heat required in these thermal oxidizers is recovered and reused.

The current Design-Build-Operate contract between New England Fertilizer Company (NEFCO) and GLWA runs through October 13, 2037. At that time the facility will be turned over to GLWA in accordance with the provisions of the Contract, including in “as new” condition, and with appropriate training of the GLWA staff.

7.8.2.6 Lime Addition/Stabilization

The Central Offload Facility (COF) has the capacity and capability of offloading sludge from all three dewatering complexes and started operation in 2005. The COF has three rectangular live bottom sludge storage bins with associated discharge screws. Each bin has a storage capacity of 200-220 wet tons, with two discharge points underneath each bin. The bins are used to store the dewatered sludge cake received from upper and lower levels of C-II Dewatering via conveyor belts, and from C-I Dewatering via cake pumps through a 16-inch diameter pipeline.

Sludge can also be directed to lime mixers before offloading to a truck. The purpose of lime addition is to reduce odors if the solids are landfilled or to meet Class B requirements if the solids are land applied. There are three lime silos with associated equipment.

The COF has a rated firm capacity of 300 dtpd.

7.8.2.7 System Capacity and Operation

Upon completion of the Biosolids Drying Facility, the WRRF has been complying with the NPDES permit and Administrative Consent Order (ACO) requirements to have 850 dtpd peak solids handling and disposal capacity (calculated as the peak 10-day rolling average). Figure 7-12 summarizes the system capacity.

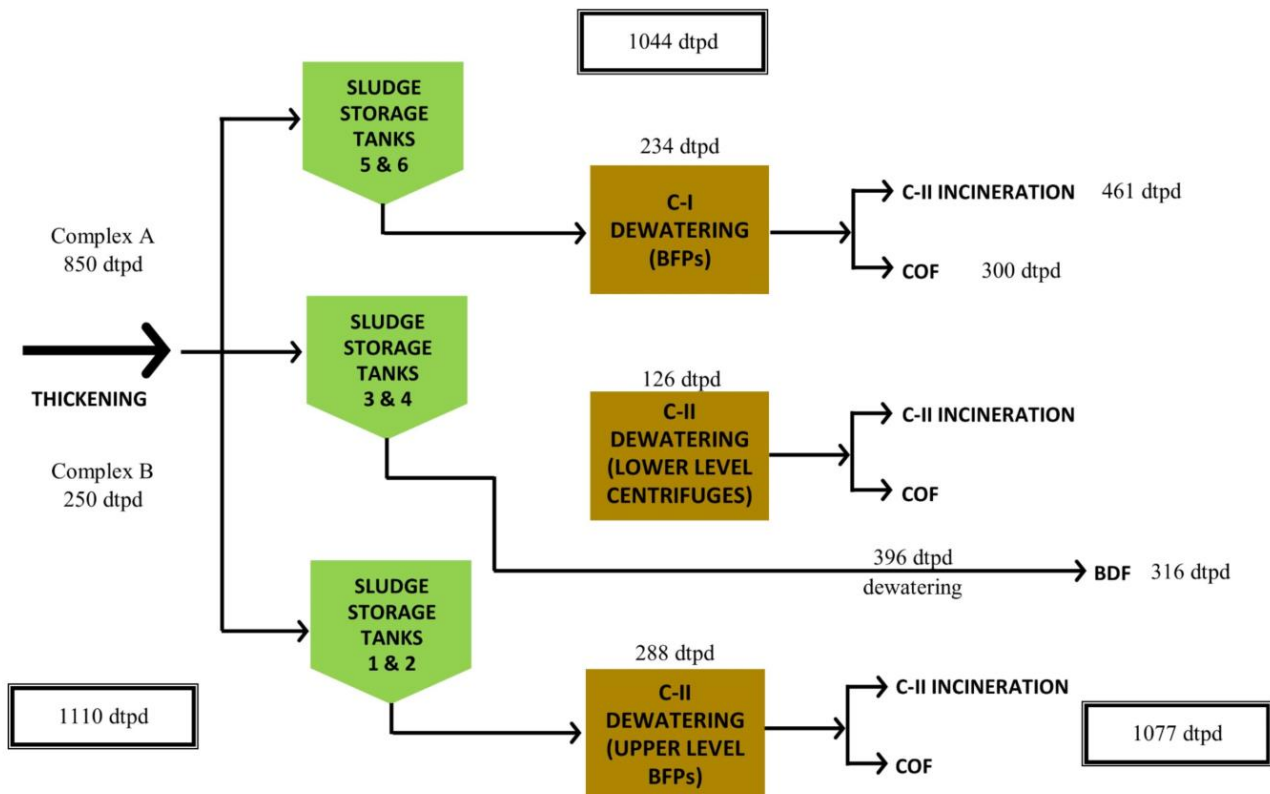

Figure 7-12. Capacity of Solids Handling System

Since the BDF went into full operation in February 2016, it has become the primary sludge disposal method. By contract, a guaranteed annual minimum of not less than 73,000 dry tons per year or ~200 dry tons per day (dtpd) shall be provided to the BDF. After the BDF, C-II incineration is the preferred disposal alternative, and lastly the COF. In order to be sure disposal capacity is available when needed, incinerators are maintained in “hot standby” mode which requires a significant consumption of natural gas.

In fiscal year 2018 (July 1, 2017 to June 30, 2018) 58% of the sludge generated was processed through the BDF, 33% was incinerated and the balance, 9% was processed through the COF. This data for was analyzed to estimate the unit cost for processing through the C-II incineration, the COF, and the BDF. The BDF was evaluated two ways: per the actual costs under the long-term contract with NEFCO and estimated if GLWA were to operate and maintain the facility in the future as shown

in Table 7-12. A more detailed breakdown of these costs is presented in Technical Memorandum 5B.

Table 7-12. Solids Disposal Unit Cost Summary

Parameter	C-II Incineration	COF	BDF (Actual Cost per Contract)	BDF (Estimated Cost)
Total Cost	\$8,465,192	\$2,361,055	\$16,630,738	\$12,674,756
Total Tons Sludge Processed (dry ton/year)	39,939	10,659	69,160	69,160
TOTAL	\$212	\$222	\$240	\$183

7.8.3 Historical Solids Production

The biosolids production and end use for the last ten years is presented in Table 7-13. As expected, the table shows a general decline in the amount incinerated, land applied or landfilled since the BDF was placed into operation in 2016.

Table 7-13. Biosolids Production and End Use (2008 to 2018)

Year	Landfill (DT/YR)	Land-Applied (DT/YR)	Burned (DT/YR)	BDF (DT/YR)	Total (DT/YR)	Total (DT/DAY)
2008	55,863	-	102,276	-	158,139	433
2009	41,761	-	111,394	-	153,155	420
2010	51,833	-	109,662	-	161,494	442
2011	62,220	4,937	105,209	-	172,365	472
2012	53,367	13,241	111,094	-	177,702	487
2013	59,826	18,963	102,448	-	181,237	497
2014	71,376	11,072	104,727	-	187,175	513
2015	45,610	4,542	90,605	6,958	147,715	405
2016	40,538	1,326	21,089	67,022	129,975	356
2017	25,073	-	25,845	90,361	141,280	387
2018	4,774	-	36,610	91,183	132,567	363
MIN	4,774	-	21,089	-	129,975	356
MAX	71,376	18,963	111,394	91,183	187,175	513
AVG	46,567	5,408	83,724	23,229	161,024	434

As with all treatment facilities, especially those with multiple outlets for biosolids, the sludge production can be difficult to estimate due to the variability inherent in the estimating, including frequency of sampling (e.g daily, weekly, monthly), location of sampling (thickened sludge, dewatered sludge, ash), and the means of measuring (grab samples, pump curves, truck scale). Plant records from fiscal year 2015 to 2018 (June 1, 2014 to June 30, 2018) show an average of 415 dtpd based on disposal data, compared to 457 dtpd based on thickened sludge data and 432 dtpd as modeled using the Biowin™ model developed for the liquid train processes. As presented, the

quantity can vary as much as 10 percent. This variance suggests the thickened sludge data may possibly be overestimating the sludge production.

Figure 7-13 presents the daily, 10-day and 30-day variations in reported thickened sludge production. The peak ten-day moving average for this four-year period is 760 dtpd. This is significantly lower than prior estimates which drove the ACO requirement of providing the capacity to handle 850 dtpd during the peak 10-day period.

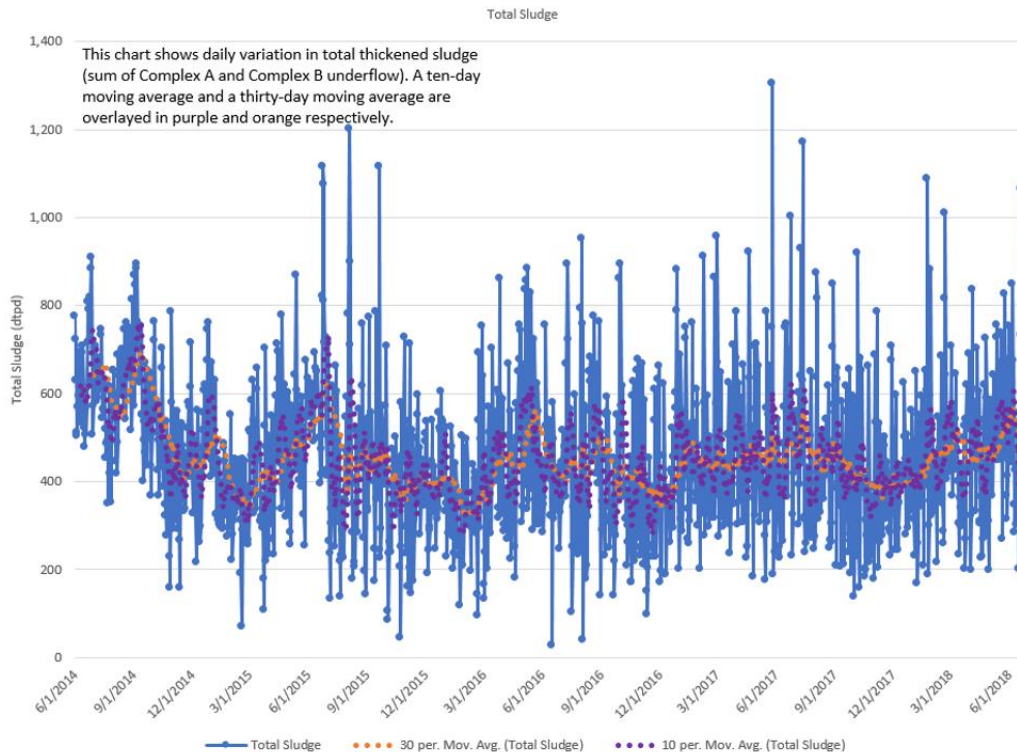

Figure 7-13. Daily, 10-Day and 30-Day Moving Average of Thickened Sludge Production

The data also shows great variability in the volatile suspended solids (VSS) concentration which is due to high grit loading under peak flow events and poor grit capture in the headworks. The low VSS impacts the fuel (natural gas) quantity needed for the BDF and C-II incineration, as well as the amount of energy that can be recovered in the future. Recommended improvements to the headworks facilities will reduce the inerts in the sludge, decrease sludge volume and increase the % VSS.

7.8.4 Future Solids Production

As presented in Section 7.2, the GLWA service area population is expected to increase over the planning period thereby increasing the sanitary flow into the system. Per capita estimates were used to estimate increases in influent BOD, TSS, VSS, TKN, and TP and added to existing loads and flows based on fiscal year (FY) 2015 to 2017.

Based on the 2060 estimated influent flows and concentrations, process simulations using Biowin™ software, and alternative liquid treatment scenarios, the future estimated sludge production was established and is presented in Table 7-14. As presented, future sludge production is expected to increase by less than ten percent.

Table 7-14. Comparison of Existing Versus Future Estimated Sludge Production

Parameter	Current Average Sludge Production	Current Maximum Month Sludge Production	Future Average Sludge Production	Future Maximum Month Sludge Production
TPS TSS (dtpd)	339	506	351	510
TWAS TSS (dtpd)	118	133	146	185
Total TSS (dtpd)	457	639	497	694

It is anticipated that these future estimates are conservative since (1) the existing sludge production records based on thickened sludge data appear high and (2) recommended upgrades to the grit handling systems at PS1 and PS2 will reduce grit carryover and likely be completed prior to any significant solids handling improvements.

7.8.5 Technology Identification and Screening

When looking ahead 40 years to improvements to the biosolids processing facilities, the integrity and remaining useful life of the existing assets were assessed as well as industry trends which are disrupting status quo in the industry in terms of available technologies, regulations and ultimate disposal.

7.8.5.1 Project Drivers

Since the prior studies were conducted, most notably the 2012 Biosolids Management Symposium and the 2010 Biosolids Disposal Alternatives Evaluation, the following industry trends have been developing:

- Continued focus on resource recovery (methane and nutrients),
- Added restrictions on land application of biosolids,
- Heightened concern over emerging contaminants in biosolids including organics and PFAS,
- More experience with thermal hydrolysis processes and installations,
- Thermal processes which can produce biofuels, biogas, or biochar,
- Food waste diversion from landfills to WRRFs,
- Increasing attention to climate change and reduction of GHG emissions, and
- Carbon (as CO₂) taxes or cap and trade for fossil fuels.

7.8.5.2 Screening of Alternatives

Given the drivers and trends identified above, the universe of potential technologies was developed by major unit process – digestion including pre-treatment, dewatering, drying, thermal processes and phosphorus recovery. These technologies are further described in Technical Memorandum 5B. For the purpose of this Master Planning it is assumed that the gravity thickeners for primary sludge and WAS thickening will remain in service.

Each technology was assessed and a technology passed the screening stage if:

- Commercially Available
- Number of Global Installations > 5
- Largest Installation > 50 MGD plant
- Technology Development Level > 2 (as defined by WRF)
- Discretion (i.e., space for solar drying, sensible for this scale).

The technologies that received a passing score are shown in **Table 7-15**.

Table 7-15. Technologies that Passed Screening

Unit Process	Technology
Digestion	Mesophilic Anaerobic Digestion (MAD) Thermophilic Anaerobic Digestion (TAD) Temperature Phased Anaerobic Digestion (TPAD)
Digestion Enhancement/Lysis	Recuperative Thickening Pre-digestion Thermal Hydrolysis (TH) Process Thermo-Chemical Hydrolysis (TCH)
Dewatering	Centrifuge Dewatering Belt Filter Press Dewatering Screw Press Dewatering
Drying	Rotary Drum Dryer Tray Dryer Fluidized Bed Dryer
Thermal	Fluidized Bed Incinerator
Phosphorus Recovery	AirPrex Ostara Phosphaq

From these technologies the list was further reduced to the most proven and applicable to the GLWA facility and eight process train configurations were developed in addition to the baseline

scenario. All alternatives with the exception of Alternative 7 include phosphorus recovery and acceptance of high strength feedstock:

1. MAD of Thickened Primary Sludge (TPS) and Thickened Fermented Sludge (TFS) with centrifuge dewatering and drying at a rehabilitated BDF.
2. TAD of TPS and TFS with centrifuge dewatering and drying at a rehabilitated BDF.
3. Sludge screening, pre-dewatering, and THP of FS and MAD of hydrolyzed sludge and TPS. Centrifuge dewatering and drying of the digested sludge at a rehabilitated BDF.
- 3a. Identical to Alt 3, but only for sludge that comes from PS2. PS1 sludge would be sent to digested sludge storage tanks for dewatering and drying.
4. Sludge screening, pre-dewatering, and THP of FS and TAD of hydrolyzed sludge and TPS. Centrifuge dewatering and drying of the digested sludge at a rehabilitated BDF.
- 4a. Sludge screening, mechanical thickening, and TCHP of FS and TAD of hydrolyzed sludge and TPS. Centrifuge dewatering and drying of the digested sludge at a rehabilitated BDF.
5. Sludge screening, mechanical thickening, and TCHP of FS and TAD of hydrolyzed sludge. Dewatering of TPS and digested sludge on Complex I/Complex II belt filter presses and incineration in new FBI.
6. Sludge screening, mechanical thickening, and THP of FS and TAD of hydrolyzed sludge. Dewatering of TPS and digested sludge on Complex I/Complex II belt filter presses and incineration in new FBI.
7. Expand the BDF to process all sludge without any THP or AD. This alternative was added after the previous alternatives had been evaluated. It does not include any acceptance of high strength feedstocks or struvite recovery like the other options.

These proposed process train configurations are shown in Table 7-16.

The baseline alternative assumes continued service of the existing thickening and dewatering systems, with preference to the biosolids drying facility and the balance of solids incinerated on the multiple hearth furnaces, while maintaining the COF as backup.

All alternatives, with the exception of the baseline and Alternate 7, include digestion as a component of the process train due to the reduction in mass achieved and methane production for heat and power generation. Six of the nine alternatives included some form of sludge pre-treatment prior to digestion to further enhance the digestion process. Two alternatives included incineration with new fluidized bed incinerator as a means to further reduce the ultimate volume requiring disposal. Although the incineration option has less opportunity for resource recovery.

Table 7-16. Proposed Process Train Configurations

Alternative Name	Sludge Screening	Mechanical Thickening/ Pre-dewatering	Sludge Pretreatment	Digestion	Final Dewatering	Thermal Processing
Baseline	N	None; just existing Gravity Thickening	None	None	Existing BFPs and Centrifuges	Existing Incineration and Drying at BDF
Alternative 1	N	Thickening	None	MAD	Centrifuge at BDF	Drying at BDF
Alternative 2	N	Thickening	None	TAD	Centrifuge at BDF	Drying at BDF
Alternative 3	Y	Pre-dewatering	THP	MAD	Centrifuge at BDF	Drying at BDF
Alternative 3a	Y	Pre-dewatering	THP	MAD	Centrifuge at BDF	Drying at BDF
Alternative 4	Y	Pre-dewatering	THP	TAD	Centrifuge at BDF	Drying at BDF
Alternative 4a	Y	Thickening	TCHP	TAD	Centrifuge at BDF	Drying at BDF
Alternative 5	Y	Thickening	TCHP	TAD	BFP at CII	Incineration in new FBI
Alternative 6	Y	Pre-dewatering	THP	TAD	BFP at CII	Incineration in new FBI
Alternative 7	N	None; just existing Gravity Thickening	None	None	Centrifuge at BDF	Drying at BDF

Alternatives carried forward shaded

7.8.6 Detailed Evaluation of Alternatives

After receiving initial equipment quotes, Alternatives 2, 4, 4a, 5, and 6 were eliminated from consideration. This decision was based on the operational simplicity of MAD over TAD, the TCHP having significantly fewer installations than the THP, and the significant capital expense of new fluidized bed incinerator.

7.8.6.1 Description of Alternatives

The alternatives carried through the life cycle cost and quadruple bottom line analysis are as follows:

Alternative 1: Mesophilic Digestion + Drying

In this alternative a portion of the primary sludge bypasses Complex A gravity thickeners and combines with the TWAS sludge from Complex B gravity thickeners and then enters the Phosphorus Release Tank for fermentation. The fermentation process increases phosphorus recovery. After leaving the Phosphorus Release Tank, the fermented sludge is thickened in the thickening centrifuges. The thickened fermented sludge, as well as the thickened primary sludge

that exits Complex A gravity thickeners, and (if accepted) high strength feedstock waste, is fed to the mesophilic anaerobic digesters. The digested sludge then enters the digested sludge storage tanks to serve as a buffer for the subsequent centrifuge dewatering and drying processes. Centrate from the thickening and dewatering centrifuges is sent to the phosphorus recovery system. Biogas from the digesters and digested sludge storage tanks are both captured and stored in a pressurized gas storage tank and used in the drying facility.

In this alternative the existing dewatering belt filter presses and centrifuges in Complexes I and II are moth-balled as well as Complex II Incinerators and used, as necessary, to manage peak periods.

Alt. 1 – Mesophilic Anaerobic Digestion (AD) + Drying

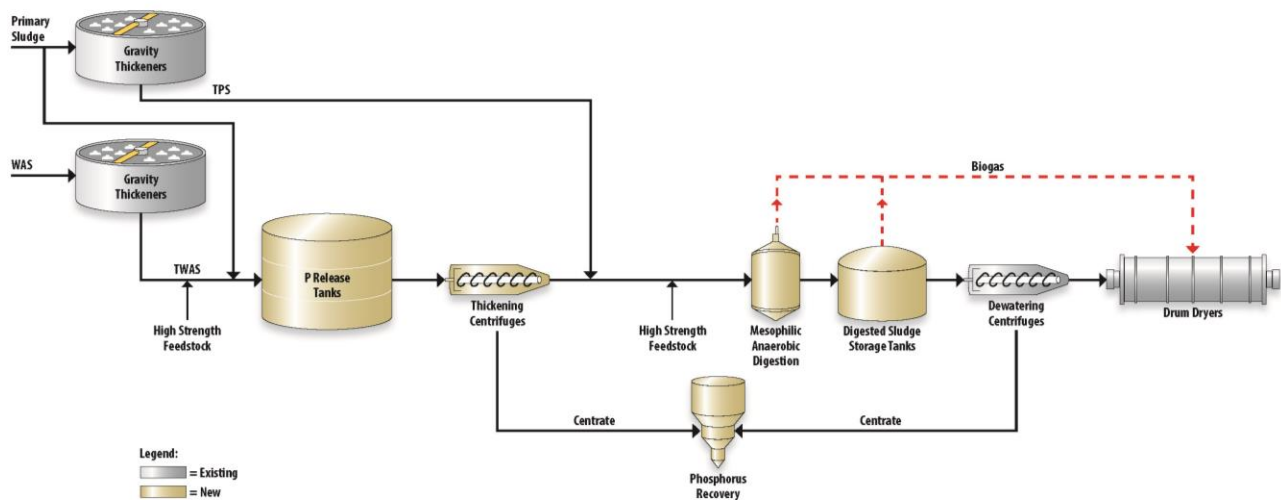

Alternatives 3: Thermal Hydrolysis Process (THP) + Mesophilic Digestion + Drying

In this alternative a portion of the thickened primary sludge (25%) from Complex A gravity thickeners combines with the thickened waste activated sludge from Complex B and enters the Phosphorus Release Tank. After leaving the Phosphorus Release Tank, the fermented sludge is screened and sent to pre-dewatering centrifuges prior to entering the thermal hydrolysis process (THP). The THP utilizing high pressure steam and a pressure differential to burst the cell wall resulting is more efficient digestion and gas production. The balance thickened primary sludge (75%) that exits Complex A gravity thickeners combines high strength feedstock waste (if accepted) and bypasses the THP and combines with the hydrolyzed sludge. This blended sludge then enters the mesophilic anaerobic digesters. The digested sludge then is sent to the digested sludge storage tanks prior to the subsequent dewatering centrifuges and dryer facility. Centrate from the pre-dewatering and dewatering centrifuges is sent to the phosphorus recovery system. Biogas from the digesters and digested sludge storage tanks are both captured and stored in a pressurized gas storage tank for use in the THP and dryer systems. This alternative reduces the

number of digesters required, improves sludge dewaterability, reduces the heat demand to the dryers and increases the amount of biogas produced.

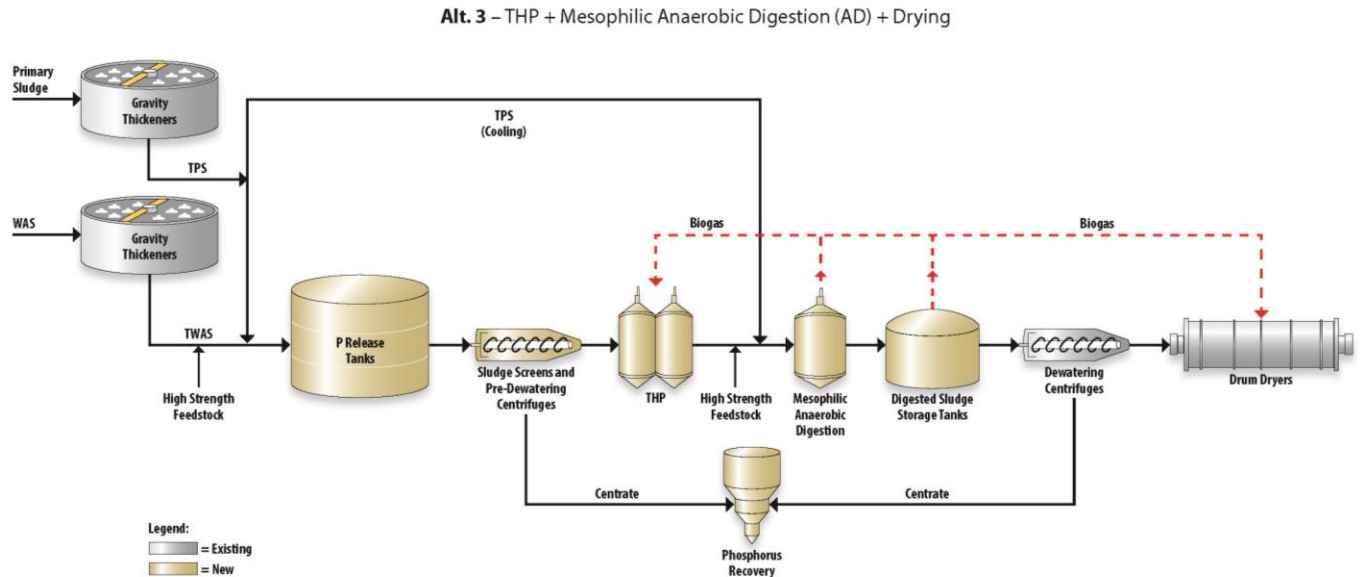

Alternative 3a: Separation of PS2 sludge with THP + Mesophilic Digestion + Drying

In this alternative influent flow from PS1 would be routed exclusively to the rectangular primary clarifiers while the more concentrated flow from PS2 would be routed to the circular primary clarifiers. Flow from each set of clarifiers would be thickened in unique gravity thickeners and only thickened sludge from the circular clarifiers (PS2) would be fed to the new biosolids process which would otherwise match Alternative 3. Thickened sludge from the rectangular clarifiers would be blended in the digested sludge storage tanks prior to final dewatering and drying. This alternative also reduces the number of digesters (as compared to Alternative 3) and diverts the more biodegradable sludge to digestion.

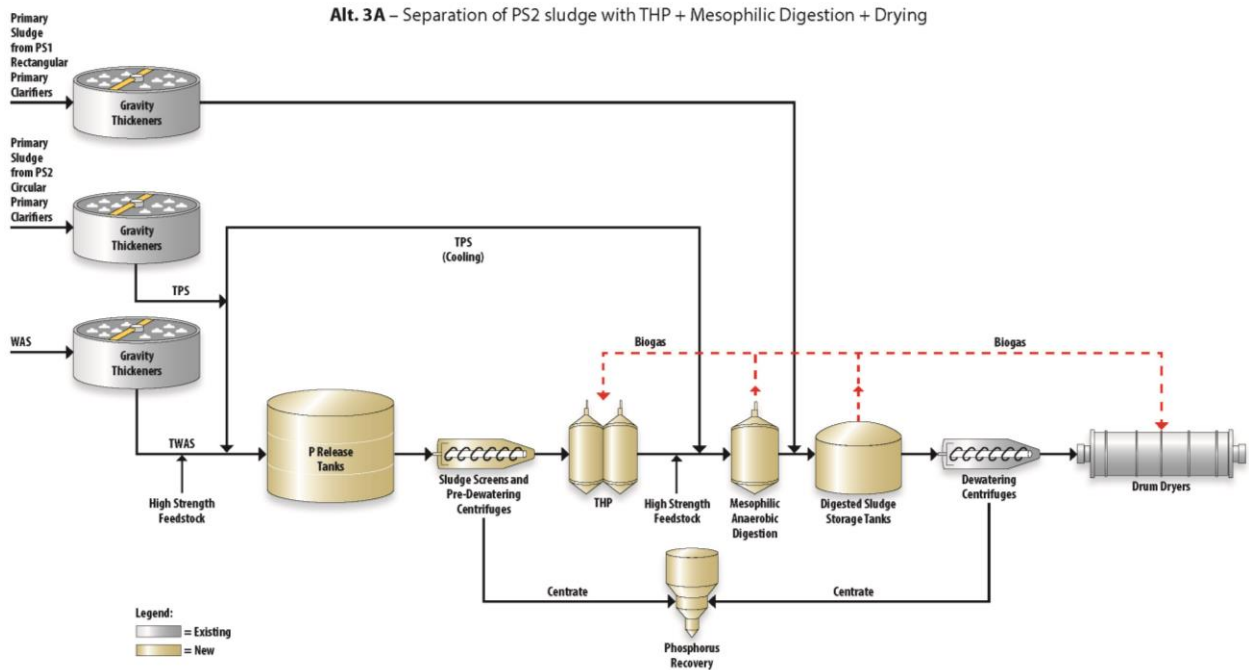

Alternative 7: Expanded Drying

In this alternative, the thickened primary sludge from Complex A gravity thickeners combines with the TWAS from Complex B gravity thickeners and enters the existing Sludge Storage Tanks where it is pumped to an expanded BDF with eight trains (seven duty, one standby) of dewatering centrifuges and dryers. The BDF would be heated with natural gas and the pellets stored in silos and taken for offsite beneficial use or disposal.

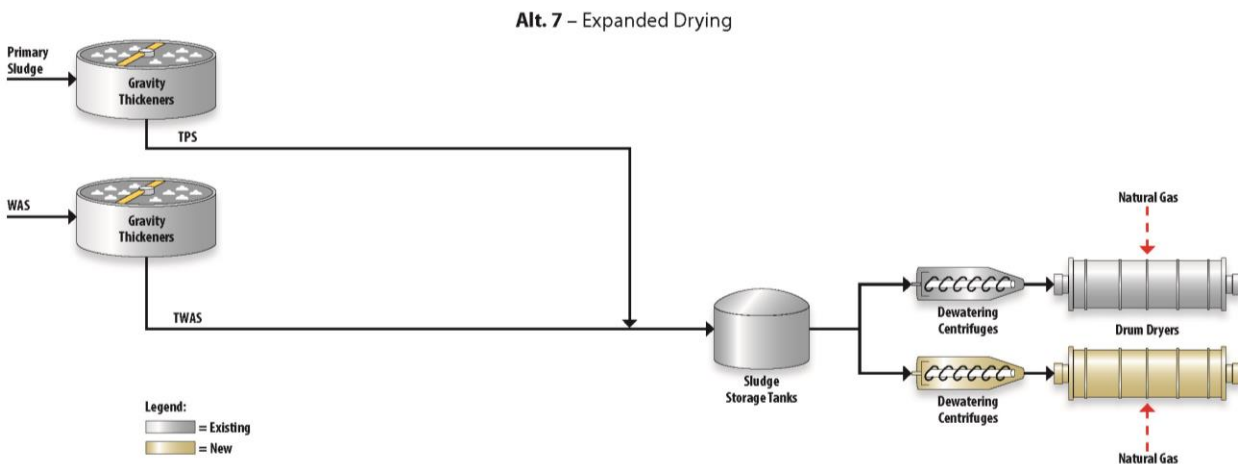

7.8.6.2 Cost Analysis

Table 7-17 shows a summary of the estimated capital costs for the baseline scenario and the four preferred alternatives. A detailed breakdown for the alternatives is presented in Technical Memorandum 5B.

Table 7-17. Summary of Estimated Capital Costs

Alternative	Estimated Capital Cost (in millions)
Baseline	\$60
1	\$454
3	\$490
3a	\$319
7	\$183

Key findings from the cost analysis show:

- O&M cost is drastically reduced for Alt. 1, 3, and 3a compared to the baseline and Alt. 7, based on reduced hauling and disposal costs, reduced purchase of natural gas, and reduced use of polymer for dewatering.
- Net Present Value for Alt. 3a and 7 are the lowest compared to the baseline.
- Alt. 3a appears to offer the best balance of focused resource recovery and cost, compared to the other digestion related options with and without THP.
- GHG emissions are ~50% or less for Alt. 1, 3 and 3a compared to the baseline and Alt. 7. If there is a tax or credit in the future, this could make the digestion-based alternatives more cost effective.
- There is a considerable amount of unused digester gas for the “to drying” scenarios that could be used for other future use.

7.8.6.3 Quadruple Bottom Line Evaluation Criteria

Evaluation criteria developed for the GLWA resource recovery alternatives analysis have been organized into four categories in accordance with a Quadruple Bottom Line (QBL) approach:

- Economic
- Environmental
- Social
- Operational

Allocating the evaluation criteria into these categories helped identify alternatives that best meet GLWAs overarching goals and evaluate parameters in addition to cost. Generally, it was found that

the drivers in the analysis revolve around the ultimate solids output (and the unit cost for biosolids disposal), GHG emissions and recoverable biogas (and the unit price of power, natural gas), sludge dewaterability and the required number of new assets that need to be operated and maintained and/or those assets that can be retired. The baseline alternative, which includes incineration, results in the lowest solids output, whereas Alternative 7 which includes neither incineration nor digestion results in the highest solids output. When comparing alternatives that include digestion, those with a THP process produce less solids. The value/cost of the resulting product produced depends on its ultimate fate – landfill or reuse. Those alternatives that include digestion produce a recoverable biogas that can off-set the fuel needed in the process and reduce GHG emissions overall. Those with a THP process produce more biogas. The number and type of assets that need to be operated and maintained vary for each alternative and need to be balanced with the benefits those assets provide.

From the QBL scoring detailed in Technical Memorandum 5B, the baseline and Alt. 3 scored least favorably, while Alt. 1 and 7 were the most favorable.

7.8.7 Next Steps/Implementation Considerations

GLWA is prioritizing studies and CIP that address asset management of current infrastructure to improve reliability, reduce O&M costs and provide flexibility for the future. At this time, it is expected that the existing infrastructure for biosolids management can function adequately through 2035.

However, the following triggers should continue to be monitored over the next 15 years which may alter decision-making in the scheduling and/or recommendations for biosolids processing.

- **Incinerator Air Emission Standards.** There is no current indication that the EPA will be issuing more stringent emission limits on existing sludge incinerators. However, new sludge incinerators may be more likely to be subject to new emission limits.
- **PFAS and Emerging Contaminants.** It is too early to predict what impact emerging contaminants such as PFAS may have on WRRF treatment and disposal. Land application of biosolids may be restricted to reduce the risk of trace contamination of soil and groundwater. Additional research is required on the fate and transport of PFAS through varying treatment processes. GLWA is currently participating in this research.
- **Fuel Costs.** The cost of natural gas and electricity is highly variable and significantly impacts the cost analyses presented.
- **Revenue Offsets.** The supply and demand of natural phosphate rock may drive up the cost of this commodity and thus the revenue for a recovered struvite product.
- **GHG Emission Regulations.** Whether or not a future tax or credit is allotted to GHG emissions is another item to follow closely as the impacts of climate change get more attention.

- **General Biosolids Management.** The cost of biosolids disposal is increasing in many areas around the country well above inflation rates. The quantity of biosolids, outlets for beneficial reuse or disposal and unit cost may greatly impact decision making for the future.

7.8.7.1 Advance Key Research & Innovation Projects

The GLWA Energy, Research and Innovation (E,R&I) group monitors and performs ongoing research and technologies that can move the WRRF towards more efficient, resilient and sustainable operations, ultimately to a Utility of the Future where energy use is net zero and resources are recovered. As of the fall of 2019, GLWA has 21 projects in process. Those focused on biosolids are summarized in Table 7-18. Results from these projects will inform future investments.

Table 7-18. Current Energy, Research and Innovation Projects Related to Biosolids/Resource Recovery

Project Name	Project Number	Project Type	Status	Initiation Date	Duration	End Date/ Projected End Date	GLWA Commitment	Partnering Entities	Short Project Description
Energy Recovery Assessment	CS-217	Research	Ongoing	10/1/2017	2 years	9/30/2019 (Extension in process)	Cash \$355,800	Michigan State University Steve Safferman	This research project is designed to assess the biogas potential of the biosolids, with and without added organics, the ability of the current plan to handle the recycle stream, perform preliminary energy balances and cost benefit analysis and move the bench scale testing to pi lot scale to validate the digestion characteristics, the stability when feeding additional organics end biogas characteristics
Hydrothermal Liquefaction (HTL)	EERE 325 (HYDROPOWE RS- LIFT20SG17)	Pilot Scale Study	Completed	Early 2 nd Qtr 2017	2 years	4/31/2019	In-kind \$10,000	WE&RF, DOE, Pacific Northwest Laboratory & others	A consortium led by the Water Environment & Reuse Foundation (WE&RF) has been selected by the Department of Energy for award negotiations to begin Phase 1 design and planning for a pilot plant to produce clean hydrocarbon fuels at a municipal wastewater treatment facility. The project will use breakthrough technology to produce fuels such as gasoline, jet fuel, diesel and renewable natural gas from wastewater solids. Due to GLWA participation with bench scale testing, GLWA will be participating on the project Advisory Committee

Project Name	Project Number	Project Type	Status	Initiation Date	Duration	End Date/ Projected End Date	GLWA Commitment	Partnering Entities	Short Project Description
Transport and Fate of Nutrients in Biosolids	1902059	Research	Procurement	TBD	24 months	TBD	Cash \$227,500	Michigan State University Steve Safferman/ Ehsan Ghane/Wei Zhang	Assess fate and transport of nutrients in GLWA biosolids. Estimate amount of nutrients available for plant growth, predict the amount of nutrients that migrate below the root zone, impact of microbiome of nutrient mobility.
PFAS Release from Finished Biosolids	WRF X (Tailored collaboration)	Research	WRF Procurement	TBD	12 months	TBD	Cash \$20,000 in-kind \$5,000	Water Research Foundation, CDM Smith, Purdue, NEBRA	Assess poly and perfluoroalkyl substance release from finished biosolids; as a function of PFAS loading, post-digestion processing and field aging.
Characterization and Contamination testing of Source Separated Organics	WRF 4915	Study	On Hold	March 2019	20 months	TBD	Project Advisory Committee	Water Research Foundation, Carollo Engineers, University of Michigan	Develop industry guidance for characterization and quality evaluation of source separated organics (SSO) to be used as a feedstock to resource recovery facilities co-digestion units. Partner dropped out, Carollo had to locate new one. The new university partner will be UM – Lute Raskin’s group. Has yet to restart.

Not included in this table is the pyrolysis pilot test being conducted at the Carmeuse Lime & Stone plant (Rouge River) located 1 mile away. Currently, BDF pellets are fed in a small batch of 50 lb/day and run through an electric pyrolysis unit operated typically at 650°F and a retention time of 15 to 30 minutes with the intent to offset fuel costs (natural gas and coal) for their lime kilns either with a low-grade methane gas or char that comes from a renewable fuel source.

7.8.7.2 Future Study of Next Generation Biosolids Improvements

Considering the CIP projects and ongoing maintenance which address current infrastructure, and by contract the BDF being turned over to GLWA in October 2037 in “as new” conditions with spare parts and training, the next phase of biosolids alternatives evaluation is suggested to begin around 2028.

Between now and 2028, GLWA should continue to monitor its 10-day peak solids loads. The NPDES permit requires that GLWA maintain capacity for a 10-day peak load of 850 dtpd, but data since 2014 show the 10-day peak of approximately 760 dtpd in August 2014, and since that time no 10-day peaks greater than approximately 650 dtpd has been reported. A reduction in the 850 dtpd permit requirement would result in significant cost savings to GLWA. In addition, the addition of new grit handling facilities at PS1 and PS2, will further reduce sludge quantities.

The next study of biosolids improvements should assess:

- Ongoing trends in biosolids production, including the 10-day rolling average
- Electrical energy, natural gas, and struvite prices, as well as disposal costs for landfilling, ash, pellets and sludge from the Central Offload,
- Air emission and land application regulatory trends
- New technologies or advances in innovative technologies including those cited in Technical Memorandum 5B
- Operating experience with new grit removal improvements at PS1 and PS2, and updated estimates of grit capture and biosolids VSS
- Dewatering performance (cake solids and polymer usage) as ferric chloride dose is reduced and EBPR process is implemented
- North American experience with the THP process: several new THP plants have been coming online since 2017, and the operational performance of these facilities will provide important information for cost and performance projections.
- Updates on the market for GLWA biosolids product and for high strength organic waste for potential co-digestion.
- Updated condition assessment of incinerators, dewatering facilities, COF, and potential for contract term extension for operation of the BDF
- A re-analysis of net present value costs for alternatives 1, 3, 3A and 7 relative to updated baseline alternative.

- Change in 503 regulations to include emerging contaminants.

7.9 Summary of Planned Improvements and Budgetary Estimates

The preceding sections have summarized the planned improvements on the liquid treatment train at the WRRF by unit process, including the proposed implementation schedule which prioritizes those areas most in need of repair and rehabilitation and those projects which offer a high return on investment. This section compiles the information to help visualize how each of the projects are inter-related and how costs can be expended over the forty-year planning period in a logical fashion, ensuring integration with ongoing programs, while moving the WRRF to a Utility of the Future and meeting the desired outcomes of the Master Plan.

Table 7-19 summarizes the projects developed as a part of this Master Planning effort and the proposed implementation schedule in 5-year increments. The table categorizing the projects into three buckets:

- Near-Term, High Return on Investment (ROI) Projects and Studies – include relatively low-cost modifications which result in power and chemical efficiencies and or efficiencies in operation, and studies that may lead to future value-added projects.
- Ongoing Asset Management – include primarily repair and replace-in-kind projects. Recent examples of projects that would fall in this category are the rehabilitation of the rectangular primary settling tanks and the chlorination/dechlorination improvements.
- New Function/Transformative Projects – include upgrading existing unit processes with more state-of-the-art technologies and/or projects which significantly change how flow is treated. Recent examples of projects that would fall in this category are the RRO Disinfection project which provided disinfection to the primary effluent discharge which heretofore had not been disinfected and the Biosolids Drying Facility, which significantly changed how biosolids are managed.

Table 7-19. Summary of Liquid Treatment Train Improvements

	Near-Term, High ROI, and Studies	Ongoing Asset Management	New Function/ Transformative
2020 - 2024	Ferric Chloride Addition Optimization	Rehab of Ferric Chloride System (211008)	PS2 Screen and Grit Improvements (211007)
	Aeration Decks 1 & 2: EBPR with Oxygen and Hydraulic Optimization	PS1 Improvements (211006)	Site Security/Beautification/GI
	Assessment of Hypochlorite use over time	PS2 Improvements (211005)	SFE Treatment and Storage
	Hypochlorite for full flow pilot	Aerator Replacement Decks 1&2	Aeration Decks 1 & 2: Step Feed
		Rehab of Circular Primary Clarifier Scum Removal (211009)	

	Near-Term, High ROI, and Studies	Ongoing Asset Management	New Function/ Transformative
		Gaseous Chlor/Dechlor Improvements (212004)	
		Rehab of ILPs (212008)	
		Rehab of SFE (216008)	
		Rehab of Yard Piping (216006)	
	Aeration Decks 3 & 4: EBPR with Oxygen and Hydraulic Optimization	Aerator Replacement Decks 3&4	PS1 Screen and Grit Improvements
		Rehab of Primary Clarifiers 17-18	
225 - 2029	Assessment of 3rd party Hypo generation facility near WRRF	Rehab of Secondary Clarifiers (212007)	New Connection of Oakwood Interceptor to PS2
			Aeration Decks 3 & 4: Step Feed
2030 - 2034	Assess High Rate Clarification for High Flow Management	Rehab of Primary Clarifiers 13-16	Eliminate Use of Gaseous Chlorine
	Biosolids Planning		
2035 - 2039	Assess Alternative Disinfectants	Rehab of RAS/WAS pumps	New High Rate Clarification (HRC) System
2040 - 2044		Rehab of Sodium Hypochlorite System (if remaining)	
		Rehab Remaining Rectangular Clarifiers	
2045 - 2049		Rehab of PS2 Grit and Screening	Convert HRC to Biologically Enhanced High Rate Clarification (BEHRC)
		Aerator Rehab Decks 1 & 2	
		SFE Rehab	
2050 - 2054		Rehab of PS1 Grit and Screening	
		Rehab Circular Primary Clarifiers	
		Rehab Secondary Clarifiers & Pumping	
		Aerator Rehab Decks 3 & 4	
2055 - 2060			

Table 7-20 presents active and future planned CIP projects from the 2020-2024 CIP, modifications to existing projects that have stemmed from the Master Planning effort, and new projects proposed to be included in the CIP, and the anticipated expenditures for each project by fiscal year, through 2038.

Table 7-21 presents the anticipated schedule of projects on the Liquid Treatment Train through 2060. This schedule assumes equipment requires replacement after a 20-year life, with the exception of grit and screening equipment that should be replaced every 15 years given the corrosive and abrasive environment.

Table 7-20. Estimated Expenditures thru 2013 for Active and Future Planned Projects WRRF Liquid Treatment Train

CIP#	Description	Status	FY2020	FY2021	FY2022	FY2023	FY2024	FY2025	FY2026	FY2027	FY2028	FY2029	FY2030	FY2031	FY2032	FY2033	FY2034	FY2035	FY2036	FY2037	FY2038	Total (\$1,000)
211001	Rehab rectangular primaries	active	7982	3054	0	0	0	0														\$11,036
211002	PS2 Phase 1	active	1222	0	0	0	0	0														\$1,222
211003	Rehab of primary clarifiers	reclassified	0	0	0	0	0	0														\$0
211004	PS1 Rack & Grit improvements	active	869	0	0	0	0	0														\$869
211005	PS2 Improvements	future planned	0	684	711	611	8668	10925														\$21,599
211006	PS1 Improvements	active	1803	2325	8424	8370	811	84														\$21,817
211007	PS2 Screen and Grit Improvements	future planned	1000	5000	8000	22000	16000	8000	4700													\$64,700
211008	Rehab of Ferric Chloride System	active	2950	4983	1600	0	0	0														\$9,533
211009	Rehab of Circular Clarifier Scum Removal	future planned	0	778	619	5237	4725	35														\$11,394
2110XX	PS1 Screen and Grit Improvements	future planned									5000	10000	25000	25000	25000	15000	5000					\$110,000
2110XX	New Connection - Oakwood Interceptor to PS2	future planned								2000	3000	5000	3000	1200								\$14,200
2110XX	Rehab Primary Clarifiers 17-18	future planned						500	750	2500	1000	500										\$5,250
2110XX	Rehab Primary Clarifiers 13-16	future planned										500	1500	3000	3000	1000	500					\$9,500
2110XX	New High Rate Clarification (HRC) System	future planned																5000	10000	27000	31000	\$73,000
212004	chlor/dechlor improvements	active	1000	500	0	0	0	0														\$1,500
212006	RRO Disinfection	active	4583	0	0	0	0	0														\$4,583
212007	rehab of secondary clarifiers	future planned	0	0	0	71	933	29114														\$30,118
212008	rehab of ILPs (incl with Decks 1,2, 3 &4)	reclassified	0	0	0	0	0	0														\$0
2120XX	Aeration Decks 1 and 2: EBPR w/ Oxygen and Hydraulic Optimization	future planned		500	1000	2000	2000	1270														\$6,770
2120XX	Aeration Decks 3 and 4: EBPR w/ Oxygen and Hydraulic Optimization	future planned									500	1000	2000	1490								\$4,990
2120XX	Aeration Decks 1 & 2: Step Feed and ILP Mods	future planned		1000	3000	8000	12000	11000	4100													\$39,100
2120XX	Aeration Decks 3 & 4: Step Feed and ILP Mods	future planned									2000	6000	16000	24000	24000	17840						\$89,840
2120XX	Aeration Decks 1 & 2: Aerator Replacement (bays 4-10)	future planned				1500	2500	2500	2,060													\$8,560

CIP#	Description	Status	FY2020	FY2021	FY2022	FY2023	FY2024	FY2025	FY2026	FY2027	FY2028	FY2029	FY2030	FY2031	FY2032	FY2033	FY2034	FY2035	FY2036	FY2037	FY2038	Total (\$1,000)
2120XX	Aeration Decks 3 & 4: Aerator Replacement (bays 3-8)	future planned											1500	2500	2000	1610						\$7,610
2120XX	Convert to Hypo all Flow	future planned											500	1000	3000	1000	500					\$6,000
2120XX	Assess Alternative Disinfectants	future planned																500				\$500
214001	IWC operation	active	7567	0	0	0	0	0														\$7,567
216004	rehab of sampling sites	active	3921	607	0	0	0	0														\$4,528
216006	rehab of yard piping	future planned	323	5258	3849	4500	3500	7423														\$24,853
216007	3rd electric feed	active	1381	3374	0	0	0	0														\$4,755
216008	rehab of SFE	active	1091	991	9475	7805	5535	0														\$24,897
2160XX	SFE Treatment	future planned		500	2000	3000	2500	1000														\$9,000
2160XX	Site Security/Beautification/Green Infrastructure	future planned			500	3000	5000	1500														\$10,000

- Notes: 1. Estimated costs for active projects and future planned projects 211009, 212007 and 216006 from GLWA's FY2020-2024 CIP
 2. Estimated cost for conversion to hypochlorite all flows is a placeholder and subject to the assessment of hypo use over time
 3. Estimated cost for Site Security/Beautification/Green Infrastructure is a placeholder.
 4. Cost for new HRC system is not the total costs as implementation extends beyond FY2038.

Table 7-21. Schedule of Active and Future Planned CIP Projects WRRF Liquid Treatment Train

	CIP No.	2020	2021	2022	2023	2024	2025	2026	2027	2028	2029	2030	2031	2032	2033	2034	2035	2036	2037	2038	2039	2040	2041	2042	2043	2044	2045	2046	2047	2048	2049	2050	2051	2052	2053	2054	2055	2056	2057	2058	2059	2060					
PRELIMINARY TREATMENT																																															
Rehab of Ferric Chloride System	211008																																														
Future Rehab of Ferric Chloride System (as necessary)																																															
PS1 Improvements	211006																																														
Future PS1 Improvements																																															
PS 2 Improvements - Phase II	211005																																														
PS2 Screen and Grit Improvements	211007																																														
Future PS2 Improvements																																															
Future PS2 Screen and Grit Improvements																																															
PS1 Screen and Grit Improvements																																															
Future PS1 Screen and Grit Improvements																																															
New Connection - Oakwood Interceptor to PS2																																															
PRIMARY TREATMENT																																															
Rehab of Rectangular Clarifiers 1-12																																															
Rehab of Circular Clarifier Scum Removal	211009																																														
New High Rate Clarification (HRC) System																																															
Rehab Circular Clarifiers 17 and 18																																															
Rehab Circular Clarifiers 13-16																																															
SECONDARY TREATMENT																																															
Rehab RAS pumps																																															
Rehab of Secondary Clarifiers																																															
Aeration Decks 1 and 2: EBPR w/ Oxygen and Hydraulic Optimization	212008																																														
Aeration Decks 3 and 4: EBPR w/ Oxygen and Hydraulic Optimization																																															
Aeration Decks 1 & 2: Step Feed and ILP Mods	212008																																														
Aeration Decks 3 & 4: Step Feed and ILP Mods																																															
Aeration Decks 1 & 2: Aerator Replacement																																															
Aeration Decks 3 & 4: Aerator Replacement																																															
Future Aeration Decks 1 & 2 Improvements																																															
Future Aeration Decks 3 & 4 Improvements																																															
DISINFECTION																																															
Future rehab of Hypochlorite System (as necessary)																																															
Convert to Sodium Hypo for all flow (if feasible)																																															
Assess Alternative Disinfectant																																															
ANCILLARY FACILITIES																																															
Underground Duct Bank Repair	216001																																														
Plant-Wide Fire Alarm	216002																																														
Potable Water, SFE, Natural Gas, Compressed Air (F)	216003																																														
Rehab SFE PS and secondary water system (F)	216006																																														
Rehab Maint Bldg (F)	216005																																														

Section 8

Proposed Plan

8.1 Overview

This Section describes the major proposed projects of the Wastewater Master Plan with emphasis on the projects for the regional collection system and compliance with water quality standards. Section 7 describes proposed projects for the Water Resource Recovery Facility. Section 9 describes processes for implementation of the proposed plan. The proposed plan elements discussed in Section 8 include:

- An overview of proposed GLWA CSO controls for Phases 1, 2 and 3
- Description of major GLWA and Member CSO Controls for Phase 1 and 2
- Hub Utility Programs for the Regional Operating Plan, Regional Wastewater Collection System Model, Regional Water Quality Monitoring Program, Best Practices for Collection Systems and MS4 Systems
- Long Term Regional Collection System Improvements

Cost estimates for the capital projects and new operational programs are presented in Technical Memorandum 7.

8.2 GLWA CSO Controls

Tables 8-1 and 8-2 present the proposed controls for remaining untreated CSO outfalls on the Rouge River and Detroit River. The tables identify the CSO outfall identification, the street location from the NPDES permit. The existing regulatory status is described based on categories for CSO control established in the NPDES permit. Estimates of overflow frequency and volume are based on a 5-year review of the Post Event Report data from 2014 to 2018. The estimates of frequency and volume are qualitatively described as high, moderate, and low based on analysis of the 5-year frequencies and volume show in Figure 8-1.

Tables 8-1 and 8-2 also propose the relative sequence of future CSO control improvements based on three phases. These phases are based on planning level assessments of projected water quality improvements, financial capability, and relationship to highway collection system pipeline projects that are prerequisite to cost-effective CSO controls.

The CSO controls and phasing proposed from this Wastewater Master Plan are developed at the concept level based on the evaluation of alternatives described in Section 6. These concepts and phasing will be further examined during the upcoming GLWA Long Term CSO Control Plan scheduled for completion in November 2022.

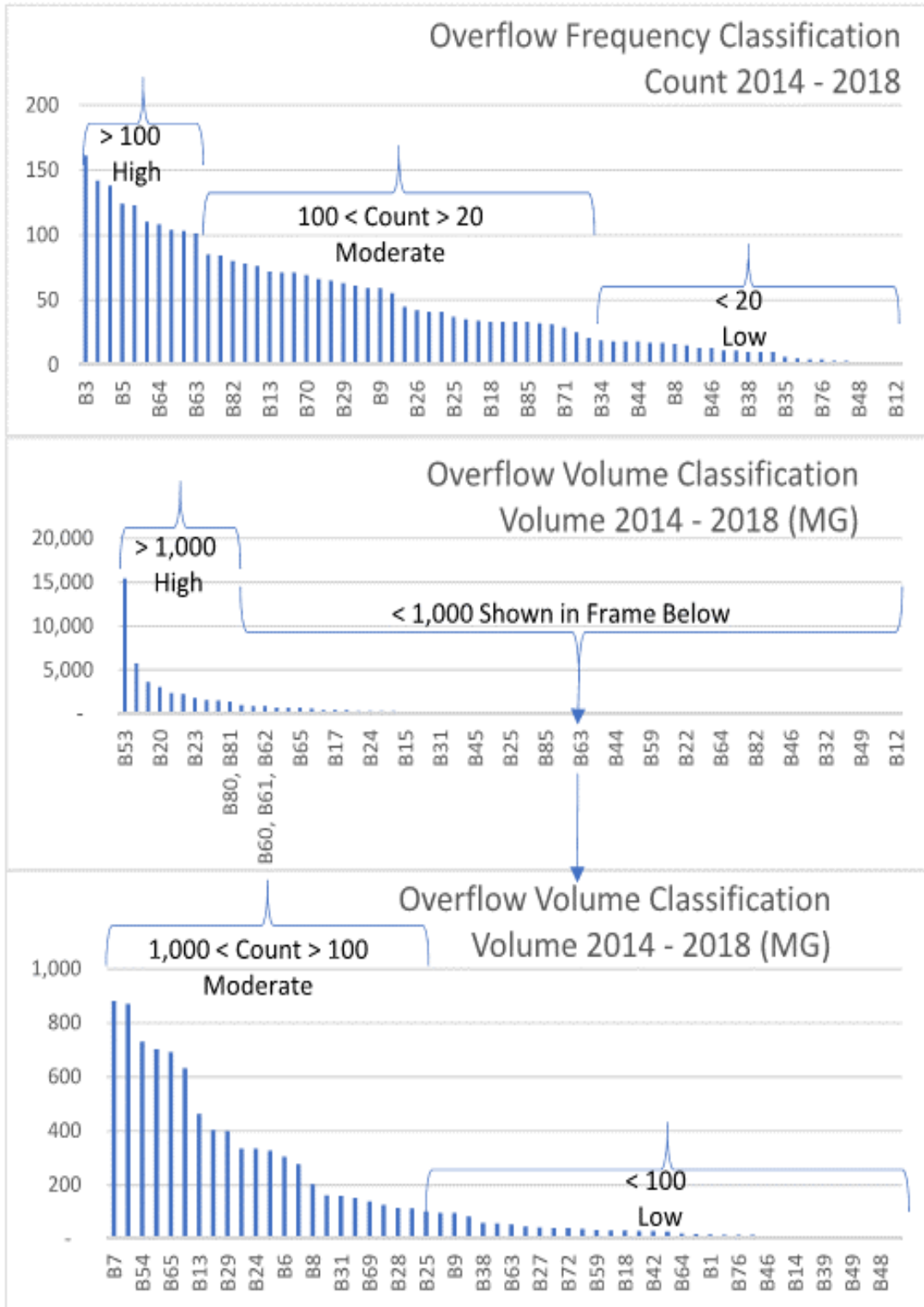

Figure 8-1. Classification of CSO Frequency and Volume

Table 8-1. Proposed Plan for CSO Controls for the Rouge River

GLWA Outfall	Location	Existing Regulatory Status	Overflow Frequency	Overflow Volume	Phase 1 Recommendations	Phase 2 Recommendations	Phase 3 Recommendations
B-046	Carbon Street	Prohibited	Low	Low	Continue to monitor. Make corrective action if status changes.		
B-049	So. Fort Street	Prohibited	Low	Low	Continue to monitor for overflow and river inflow. Make corrective action if status changes		
B-050	So. Fort Street	Prohibited	Low	Moderate	Continue to monitor. Make corrective action if status changes		
B-054	Warren	Priority	High	Moderate	Sewer separation with new storm drains, GSI and partial sewer separation underway by DWSD.		
B-056, 057, 058	Tireman	Remaining	Moderate	High	In-system storage devices to capture first flush in small storms – approximately 1” storm.	CSO Control Conduit to capture first flush in larger storms.	Add netting and in-line disinfection if this outfall exceeds criteria for Minimum Volume or Extreme Event
B-060, 061, 062	West Chicago (East Shore)	Priority	Moderate	Moderate	In-system storage devices to capture first flush in small storms – approximately 1” storm.	CSO Control Conduit to capture first flush in larger storms.	Add netting and in-line disinfection if this outfall exceeds criteria for Minimum Volume or Extreme Event
B-063	West Chicago (West Shore)	Remaining	High	Low		Perform phased sewer separation, including early investigations to determine if cost-effective near-term reductions in overflow frequency can be achieved.	

GLWA Outfall	Location	Existing Regulatory Status	Overflow Frequency	Overflow Volume	Phase 1 Recommendations	Phase 2 Recommendations	Phase 3 Recommendations
B-064	Plymouth	Remaining	High	Low	Perform phased sewer separation, including early investigations to determine if cost-effective near-term reductions in overflow frequency can be achieved.		
B-065	Glendale Relief	Priority	High	Moderate	In-system storage devices to capture first flush in small storms – approximately 1” storm.	CSO Control Conduit to capture first flush in larger storms.	Add netting and in-line disinfection if this outfall exceeds criteria for Minimum Volume or Extreme Event
B-067.068	Lahser (Dolson)	Priority	Moderate	Moderate	In-system storage devices to capture first flush in small storms – approximately 1” storm.		
B-070	Schoolcraft	Remaining	Moderate	Low		Perform phased sewer separation, including early investigations to determine if cost-effective near-term reductions in overflow frequency can be achieved	
B-069	West Parkway	Remaining	High	Moderate			
B-071	Brammell	Remaining	Moderate	Moderate		Perform phased sewer separation, including early investigations to determine if cost-effective near-term reductions in overflow frequency can be achieved	
B-072	Lyndon	Remaining	Low	Low			

GLWA Outfall	Location	Existing Regulatory Status	Overflow Frequency	Overflow Volume	Phase 1 Recommendations	Phase 2 Recommendations	Phase 3 Recommendations
B-075	Fenkell (East Shore)	Remaining	Low	Low		Perform phased sewer separation, including early investigations to determine if cost-effective near-term reductions in overflow frequency can be achieved.	
B-077	Puritan (East Shore)	Remaining	Moderate	Low			
B-080, 081	McNichols	Priority	Moderate	Moderate	In-system storage devices to capture first flush in small storms – approximately 1” storm.	CSO Control Conduit to capture first flush in larger storms.	Add netting and in-line disinfection if this outfall exceeds criteria for Minimum Volume or Extreme Event
B-082	Glenhurst	Remaining	Moderate	Low		Perform phased sewer separation, including early investigations to determine if cost-effective near-term reductions in overflow frequency can be achieved	
B-085	Seven Mile (East Shore)	Remaining	Moderate	Low	In-system storage devices to capture first flush in small storms – approximately 1” storm.	CSO Control Conduit to capture first flush in larger storms.	Add netting and in-line disinfection if this outfall exceeds criteria for Minimum Volume or Extreme Event
B-087	Pembroke	Remaining	Moderate	Moderate	In-system storage devices to capture first flush in small storms – approximately 1” storm.	CSO Control Conduit to capture first flush in larger storms.	Add netting and in-line disinfection if this outfall exceeds criteria for Minimum Volume or Extreme Event

Table 8-2. Proposed Plan for CSO Controls for the Detroit River

Outfall	Location	Existing Regulatory Status	Overflow Frequency	Overflow Volume	Phase 1 Recommendations	Phase 2 Recommendations	Phase 3 Recommendations
B-001	Fox Creek	Prohibited	Low	Low	Continue to monitor. Take corrective action if frequency increases.		
B-003	McClellan Cadillac	Priority	High	High	Sewer Separation by converting relief sewer to separate storm drain. Collaborate with MDOT in removing stormwater from combined sewers during the I-94 Modernization Project. Sewer Separation by converting relief sewer to separate storm drain. Collaborate with MDOT in removing stormwater from combined sewers during the I-94 Modernization Project.		
B-004	Fischer	Remaining	Moderate	High	Sewer Separation by converting relief sewer to separate storm drain. Collaborate with MDOT in removing stormwater from combined sewers during the I-94 Modernization Project. Sewer Separation by converting relief sewer to separate storm drain. Collaborate with MDOT in removing stormwater from combined sewers during the I-94 Modernization Project.	Proceed with sewer separation in Phase 1, because the Fischer Sewer will become a principal new stormwater outlet for the MDOT I-94 project. If the separation plan is changed during Phase 2, consider in-system storage at Fischer and Goethe, with netting and disinfection for Phase 3.	

Outfall	Location	Existing Regulatory Status	Overflow Frequency	Overflow Volume	Phase 1 Recommendations	Phase 2 Recommendations	Phase 3 Recommendations
B-005	Iroquois	Priority	Moderate	Moderate	Sewer Separation by converting relief sewer to separate storm drain. Collaborate with MDOT in removing stormwater from combined sewers during the I-94 Modernization Project. Sewer Separation by converting relief sewer to separate storm drain. Collaborate with MDOT in removing stormwater from combined sewers during the I-94 Modernization Project.		
B-006	Helen	Remaining	Moderate	Moderate	Sewer Separation by converting relief sewer to separate storm drain. Collaborate with MDOT in removing stormwater from combined sewers during the I-94 Modernization Project. Sewer Separation by converting relief sewer to separate storm drain. Collaborate with MDOT in removing stormwater from combined sewers during the I-94 Modernization Project.		
B-007	Meldrum	Priority	Moderate	Moderate	Meldrum Sewer diversion to Leib SDF	Sewer separation of area downstream of Leib SDF diversion	
B-009	Adair	Remaining	Moderate	Low		Sewer Separation by converting relief sewers to separate storm drain.	

Outfall	Location	Existing Regulatory Status	Overflow Frequency	Overflow Volume	Phase 1 Recommendations	Phase 2 Recommendations	Phase 3 Recommendations
B-010	Joseph Campau	Priority	Moderate	High	Sewer Separation by converting relief sewers to separate storm drain. Establish a schedule for sewer separation.	If DWSD cannot begin this work until Phase 2, then consider installing in-system storage at Jos. Campau and Waterloo streets as an interim measure in Phase 1, until separation can be completed.	
B-014	Orleans	Remaining	Low	Low		Anticipate volume and frequency reduction after regulator improvements. Interconnected with B-017 service area. Study for coordinated solution in Phase 2	
B-015	Orleans Relief	Remaining	Moderate	Moderate			
B-016	Riopelle	Remaining	Low	Low			
B-017	Rivard	Remaining	Moderate	Moderate	Collaborate with MDOT I-375 project to remove storm water from the combined sewer system. After MDOT project, monitor overflow frequency reclassify to Extreme or Minimal discharge overflow, or complete sewer separation.		
B-018	Hastings	Remaining	Moderate	Low	Collaborate with MDOT I-375 project to remove storm water from the combined sewer system. After MDOT project, monitor overflow frequency reclassify to Extreme or Minimal discharge overflow, or complete sewer separation.		

Outfall	Location	Existing Regulatory Status	Overflow Frequency	Overflow Volume	Phase 1 Recommendations	Phase 2 Recommendations	Phase 3 Recommendations
B-019	Randolph	Remaining	Moderate	Moderate		Anticipate volume and frequency reduction after regulator improvements	
B-020	Bates/Brush	Priority	Moderate	High	Pilot for Netting Facility	Consider in-system storage at Brush and Montcalm and Brush and Bates in Phase 2 or Phase 3, if water quality impacts or maintenance of nets warrant a reduction in frequency	Add in-line disinfection if volume and frequency exceed criteria for Minimal or Extreme outfalls.
B-021	Woodward	Remaining	Moderate	Moderate		Anticipate volume and frequency reduction after regulator improvements	Add netting and in-line disinfection if volume and frequency exceed criteria for Minimal or Extreme outfalls.
B-022	Griswold	Minimal	Low	Low	Continue to monitor, take corrective action as necessary		
B-023	First Street	Priority	Moderate	High	Pilot for Netting Facility		Add in-line disinfection if volume and frequency exceed criteria for Minimal or Extreme outfalls.
B-024	Third Street	Remaining	Moderate	Moderate	Continue to monitor		Add netting and in-line disinfection if volume and frequency exceed criteria for Minimal or Extreme outfalls.
B-025	Sixth Street	Remaining	Moderate	Moderate	Continue to monitor		Add netting and in-line disinfection if volume and frequency exceed criteria for Minimal or Extreme outfalls.

Outfall	Location	Existing Regulatory Status	Overflow Frequency	Overflow Volume	Phase 1 Recommendations	Phase 2 Recommendations	Phase 3 Recommendations
B-026	Eleventh St.	Remaining	Moderate	Low	Continue to monitor		Add netting and in-line disinfection if volume and frequency exceed criteria for Minimal or Extreme outfalls.
B-027	Rosa Parks Boulevard	Extreme	Moderate	Low	Continue to monitor, take corrective action as necessary		
B-028	Sixteenth St.	Extreme	Moderate	Moderate	Continue to monitor, take corrective action as necessary		
B-029	Eighteenth Street	Priority	Moderate	Moderate	Pilot for Netting Facility	Add netting and in-line disinfection if volume and frequency exceed criteria for Minimal or Extreme outfalls.	
B-030		Minimal	Low	Low	Continue to monitor, take corrective action as necessary		
B-031	Twenty-Fourth Street	Remaining	Moderate	Moderate	Anticipate volume and frequency reduction after optimization of DRI regulators.		Add netting if volume and frequency exceed criteria for Minimal or Extreme outfalls.
B-032		Minimal	Low	Low	Continue to monitor, take corrective action as necessary		
B-033		Minimal	Low	Low			
B-034		Minimal	Low	Low			
B-035		Extreme	Low	Low			
B-036	Summit-Clark	Priority	Moderate	High	Pilot for Netting Facility		Add netting and in-line disinfection if volume and frequency exceed criteria for Minimal or Extreme outfalls.
B-037	Ferdinand	Remaining	Low	Low	Discharges to B-036; see control for B-036	Continue to monitor	Add netting and in-line disinfection if volume and frequency exceed criteria for Minimal or Extreme outfalls.

Outfall	Location	Existing Regulatory Status	Overflow Frequency	Overflow Volume	Phase 1 Recommendations	Phase 2 Recommendations	Phase 3 Recommendations
B-038	Morrell	Remaining	Low	Low	Anticipate volume and frequency reduction after NWI Diversion to Oakwood	Continue to monitor. Evaluate in-system storage at Morrell and Dix in conjunction with netting and disinfection in Phase 3.	Add netting and in-line disinfection if volume and frequency exceed criteria for Minimal or Extreme outfalls.
B-039	Junction	Minimal	Low	Low	Continue to monitor, take corrective action as necessary	Continue to monitor, if frequency increases, consider adding an in-system storage device in Phase 2 or 3.	
B-040	Campbell	Extreme	Low	Low	GHIB Partial Sewer Separation	Continue to monitor	
B-041	Livernois	Minimal	Low	Low	GHIB Partial Sewer Separation	Continue to monitor	
B-042	Schroeder	Remaining	Low	Low	GHIB Partial Sewer Separation	Continue to monitor	Add netting and in-line disinfection if volume and frequency exceed criteria for Minimal or Extreme outfalls.
B-044	Cary	Remaining	Low	Low	Anticipate volume and frequency reduction after NWI Diversion to Oakwood and other HGL optimization.	Continue to monitor	Add netting and in-line disinfection if volume and frequency exceed criteria for Minimal or Extreme outfalls.
B-045	Dearborn, Old Rouge	Minimal	Moderate	Moderate	Continue to monitor, take corrective action as necessary		
B-059	Pulaski, Old Rouge	Extreme	Low	Low	Continue to monitor, take corrective action as necessary		

8.3 Major Phase 1 GLWA CSO Control Projects

The major Phase 1 GLWA CSO control projects include implementation of the Regional Operating Plan, construction of regulator improvements on the Detroit River Interceptor proposed in the Interim Wet Weather Operating Plan, diversion of the Meldrum Sewer to the Leib Screening and Disinfection Facility, construction of a new control gate and diversion from the Northwest Interceptor to the Oakwood Retention Treatment Basin, construction of CSO netting facilities on four Detroit River outfalls, construction of new in-system storage devices along DWSD trunk sewers tributary to the Rouge River, and sewer separation in parts of the DWSD service area where separation was found to be cost-effective.

The proposed projects to CSO netting and to divert the Meldrum Sewer to the Leib Screening and Disinfection Facility and construct of a new control gate and diversion from the Northwest Interceptor to the Oakwood Retention Treatment Basin are described in Technical Memorandum 6A, where concept basis of design information is presented. The proposed sewer separation projects are also described in Technical Memorandum 6A. The proposed Phase 1 in-system storage concept is described below.

8.3.1 In-System Storage Concept for Rouge River Outfalls

The existing large DWSD/GLWA sewers in the West Side of Detroit have a significant amount of in-system storage that is not always filled prior to CSO occurring from the seventeen (17) CSO outfalls along the Rouge River. It is desired that this in-system storage be filled to capture the first flush of combined wastewater for smaller storms using new in-system storage devices (ISDs). Capturing the first flush for the smaller storms is expected to have a large benefit to the water quality in the Rouge River.

GLWA has ISDs at 15 locations in the large combined sewer system. These devices are all inflatable dams, and most of the dams are installed in-line in the sewers. The use of in-system storage has been shown to be effective in reducing CSO frequency – especially for small storm events. The in-system storage is utilized whenever large sewers do not flow completely full for smaller storm events.

New ISDs are recommended at nine locations shown on Figure 8-2. The total in-system storage in the upstream large combined sewers is estimated on Table 8-3. Not all of this in-system storage will be utilized for first-flush capture because the dry weather flow and the existing diversion dams at the CSO outfalls fill some of this storage. However, a significant amount of additional in-system storage will be available and is expected to reduce the frequency and volumes of CSO as indicated by the RCWS modeling results.

Table 8-3. Estimated In-System Storage at New ISD Locations

In-System Storage Device Location	Sewers Providing Storage	Total Storage Volume (MG)
Berg south of Pembroke	Northwest Interceptor, Pembroke and Hessel Sewers	2.6
Seven Mile east of Berg	Seven Mile Sewer	1.5
Six Mile and Beaverland on CSO Outfalls	Northwest Interceptor, McNichols & McNichols Relief Sewers	12.3
Burt north of West Chicago	Northwest Interceptor and Plymouth Sewer	2.5
West Chicago east of Burt	West Chicago Sewer	2.9
Trinity north of Tireman	Northwest Interceptor and Joy Sewer	3.7
Tireman east of Trinity	Tireman Sewer	2.9
Southfield north of Joy	Southfield Sewer	3.2
Tireman east of Greenfield	Hubbell Sewer	5.0
	Total	36.6

The Six Mile and Six Mile Relief CSO outfall is one of the locations recommended to have new ISDs. Figure 8-3 shows a cross-section through the Six Mile Relief sewer outfall. This CSO outfall has six (6) sections of diversion dam and six (6) parallel backwater gates. Six (6) ISDs may be required at this location. The ISDs at Six Mile may be like the Task 1 gates previously constructed in-place of the backwater gates under PC-698. The Task 1 gates were later removed, and backwater gates were re-installed under PC-788. Also, the concrete diversion dams were raised about 2.7-feet under PC-788. Alternatively, inflatable dams may be installed on top of the diversion dams at the Six Mile and Six Mile Relief sewer CSO outfall.

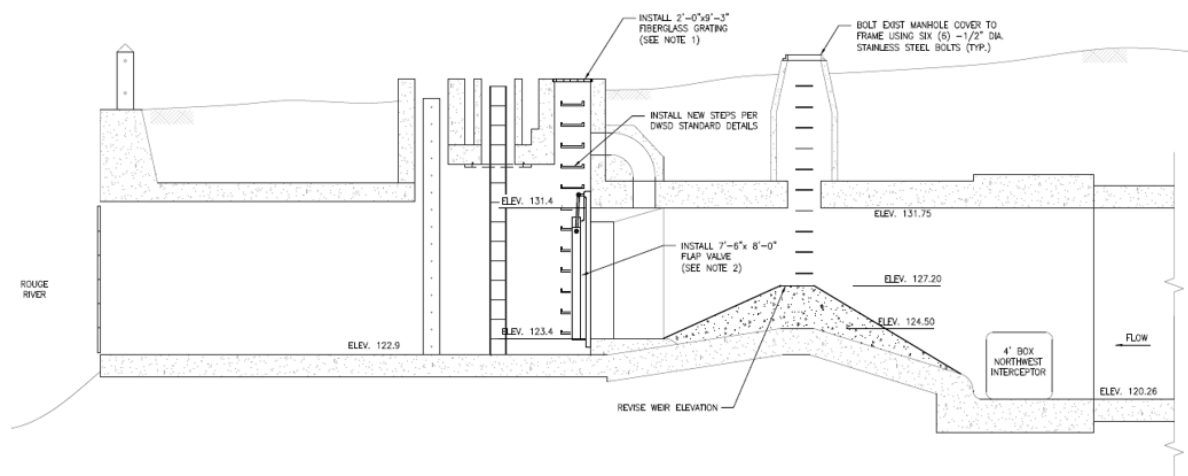
**Figure 8-3. Section Through Six Mile Relief CSO Outfall**

One ISD is likely to be required at the other eight (8) locations. Four (4) of these are along the Northwest Interceptor, and four (4) are on large combined sewers in the West Side of Detroit.

The new ISDs may be constructed using a variety of dams or gates. Alternatives include inflatable dam within a new structure, inflatable dam within existing trunk sewer, double leaf gates, single leaf gates, weir wall with orifice, weir wall with gate, radial gate, Bascule gate, butterfly gate.

The following next steps for further analysis are recommended to be included in the LTCSO Plan.

- Determine access and control vault/building locations for the ISDs
- Survey the sewer locations and related CSO outfalls
- Inspect the condition of the sewers at ISD locations
- Determine required sewer repairs (if any)
- Measure dry and wet weather flow rates at ISD locations
- Estimate available in-system storage at ISDs
- Review upstream lateral sewer connections and approximate basement elevations
- Develop critical upstream HGLs for ISD operations
- Evaluate ISD alternatives
- Perform hydraulic analyses, evaluate the risk of exceeding critical HGLs and estimate the expected CSO reduction
- Develop I&C concepts for the ISDs
- Estimate construction and O&M costs
- Develop conceptual designs and design criteria for the ISDs

8.3.2 GLWA Member CSO Control Projects in Phase 1

Dearborn, Dearborn Heights, Inkster, and Redford Township are developing CSO control projects for uncontrolled outfalls in their service districts. These projects are shown in Figure 8-4. These projects are planned to start in Phase 1 but anticipated to be fully implemented over Phase 1 and Phase 2. See Section 9 for additional information on these projects in relationship to other regional water quality projects and phases.

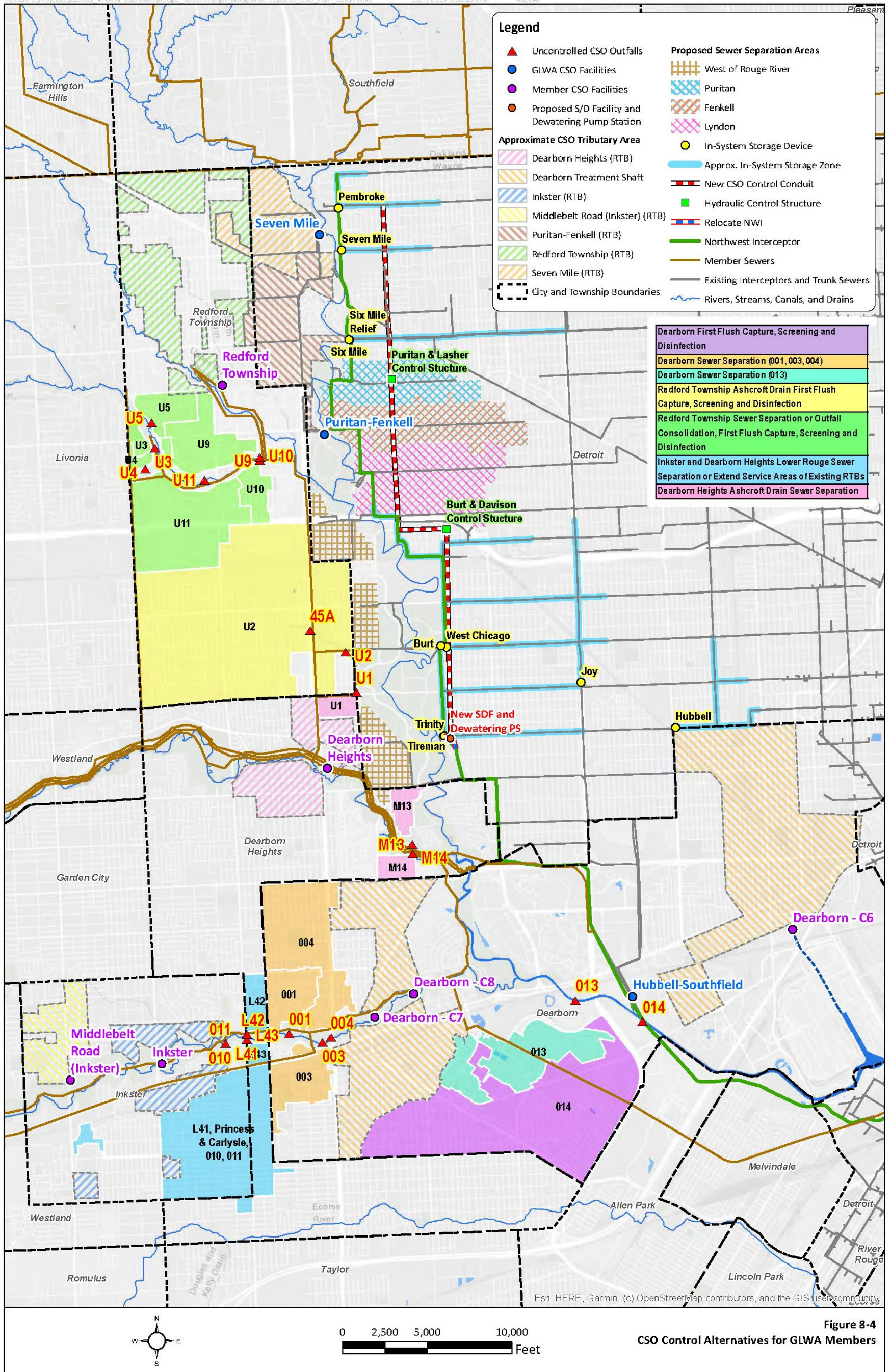

Figure 8-4. Rouge River Suburbs

8.3.3 Evaluation of GLWA CSO Operations Staffing

As GLWA completes the assessment of its CSO control assets under project CS-299, an assessment of staffing levels for its CSO program should also be performed. The level of staffing for GLWA CSO control facilities was reviewed with respect to staffing levels by Members and other wastewater utilities. In October 2019, GLWA CSO Operations Group had 25 staff and contractor positions for operation and maintenance of 9 CSO control facilities. GLWA Field Services Group has 32 budgeted positions for pump station operation and maintenance. The GLWA Field Services Group assists the CSO Operations Group on in the operation and maintenance of large pumps. All of the staff numbers cited above are inclusive of supervisor positions.

Macomb County Public Works operates and maintains two retention treatment basins with 9 staff, and Oakland County Water Resource Commission operates 4 retention treatment basins with 15 staff. When considering the number of O&M staff per 1,000 CFS of treatment capacity, of the CSO control facilities, the following numbers

- GLWA: 1.0 staff per 1,000 CFS
- MCPWO: 6.4 staff per 1,000 CFS
- OCWRC: 1.9 staff per 1,000 CFS

The Massachusetts Water Resource Authority (MWRA) has 80 staff positions for the operation of 4 CSO control facilities, 3 headworks facilities (screening and grit removal) and 12 wastewater pumping stations. The MWRA pools its field staff as needed to operate and maintain all remote facilities, so pumping station staff can assist to perform O&M on CSO control facilities when needed.

Comparisons of staffing levels between organizations are difficult to make without detailed information on job descriptions. In the report titled “Optimization of Regional Operations” prepared as part of this Wastewater Master Plan, an assessment of staffing levels is proposed for GLWA and all Members participating in the Regional Operation Plan. It is recommended that GLWA complete the staffing needs assessment proposed under the Regional Operating Plan.

8.4 Major Phase 2 and 3 GLWA CSO Control Projects

8.4.1 General

Phase 2 CSO control projects for GLWA include the continuation of proposed sewer separation projects started in Phase 1 and evaluation of the needs for additional first flush storage along the Rouge River. Phase 3 projects include the completion of sewer separation projects, the continued adaptation to changes in runoff rates due to green infrastructure implementation on private and public property. Phase 3 also includes the installation of CSO nets and inline disinfection for any remaining outfalls that exceed NPDES permit thresholds for frequency and volume of discharge and therefore require control. Section 9 describes the process of 5-year of water quality assessments, optimization, and adaptive management of new green infrastructure that should be considered in the evaluation of future Phase 2 facilities.

8.4.2 Rouge River CSO Control Conduit

A CSO Control Conduit is proposed to provide CSO control for larger storms from the combined sewer system in the West Side of Detroit. The horizontal and vertical alignment of the proposed CSO Control Conduit is shown on Figures 8-5 and 8-6.

The CSO Control Conduit is proposed to be built after the new West Side in-system storage devices (ISDs) have been installed and are in-service. The CSO Control Conduit will capture CSO after the in-system storage is full. Once the CSO conduit is full, it will operate as a flow-through tunnel with a screening/disinfection (S/D) facility at its downstream end.

The CSO Control Conduit is proposed to be a 6.5-mile-long, 14-foot diameter tunnel built as shallow as possible in soft ground. The upstream end is proposed to be at Lahser and Pembroke Roads and it will run to the south along Lahser Road to Davison Road. At Davison Road, the tunnel will turn to the east and run along Davison to Burt Road. The CSO Control Conduit will then run to the south along Burt Road to Tireman Avenue. A screening and disinfection facility is proposed to be built south of Burt and Tireman Avenue with a new outfall to the Rouge River. The Northwest Interceptor (NWI) will be relocated around the screening and disinfection facility from Trinity Street and Tireman Avenue to a point along Pierson Street north of Sawyer.

Two control structures are proposed along the CSO Control Conduit at Burt and Davison and at Lahser and Plymouth. The concept for the control structures is shown on Figure 8.7. Without the control structures, the conduit would only partially fill before it would start to discharge out of the proposed S/D facility at the downstream end. A flap gate is proposed on the divider wall so that the upstream tunnel segment can be partly filled from the downstream segment. Gates also are proposed on the divider wall that will be used to dewater the store wastewater and flush the tunnel.

The two control structures break the tunnel into three segments. The upper segment of the tunnel has a storage elevation of 604.25 feet (125 feet – Detroit datum) and a storage volume of 11.9 million gallons. The middle segment has a storage elevation of 594.25 feet (115 feet – Detroit datum) and a storage volume of 13.2 million gallons. The lower segment has a storage elevation of 582.75 feet (103.5 feet – Detroit datum) and a storage volume of 14.9 million gallons. The total storage volume of the proposed CSO Control Conduit is approximately 40 million gallons.

The screening and disinfection facility and new outfall to the Rouge River is proposed at the downstream end of the tunnel near Burt Street and Tireman Avenue. The existing B056/057/058 outfall at Tireman Avenue is proposed to be bulk-headed. A concept for the screening and disinfection facility is shown on Figure 8.8. The CSO Control Conduit will discharge to the river once the storage in the tunnel is full and the wastewater level is higher than the river level. Overflow will be screened and disinfected before it discharges to the river. Dewatering pumps will be installed in this shaft to dewater the tunnel into the NWI.

Overflow structures are proposed between the existing large combined sewers as shown on Figures 1 and 2. In total, there are twelve overflow structures that are proposed to allow overflow into the CSO Control Conduit, and preliminary concept design criteria are presented in Table 8-4.

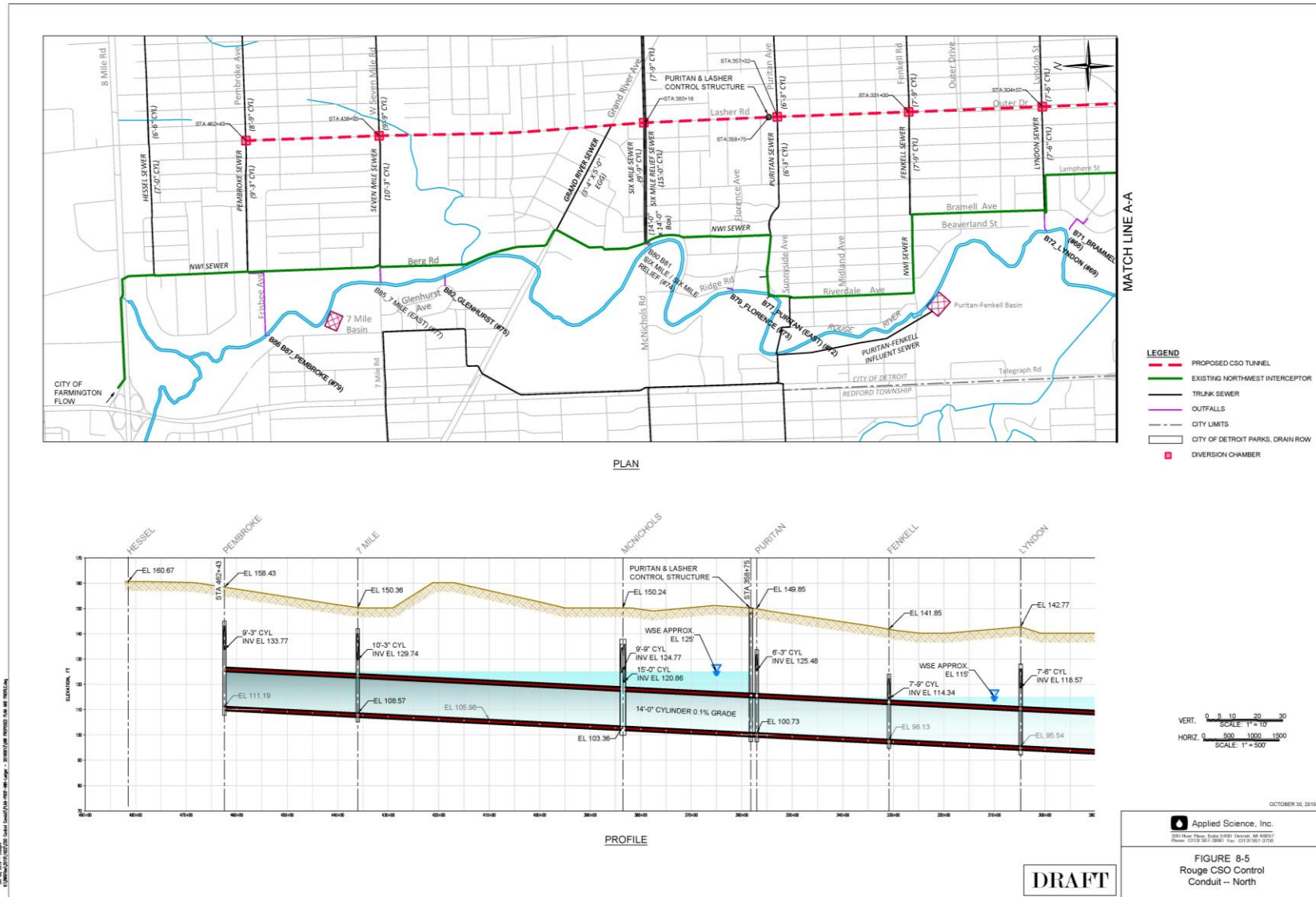

Figure 8-5. Rouge CSO Control Conduit -- North

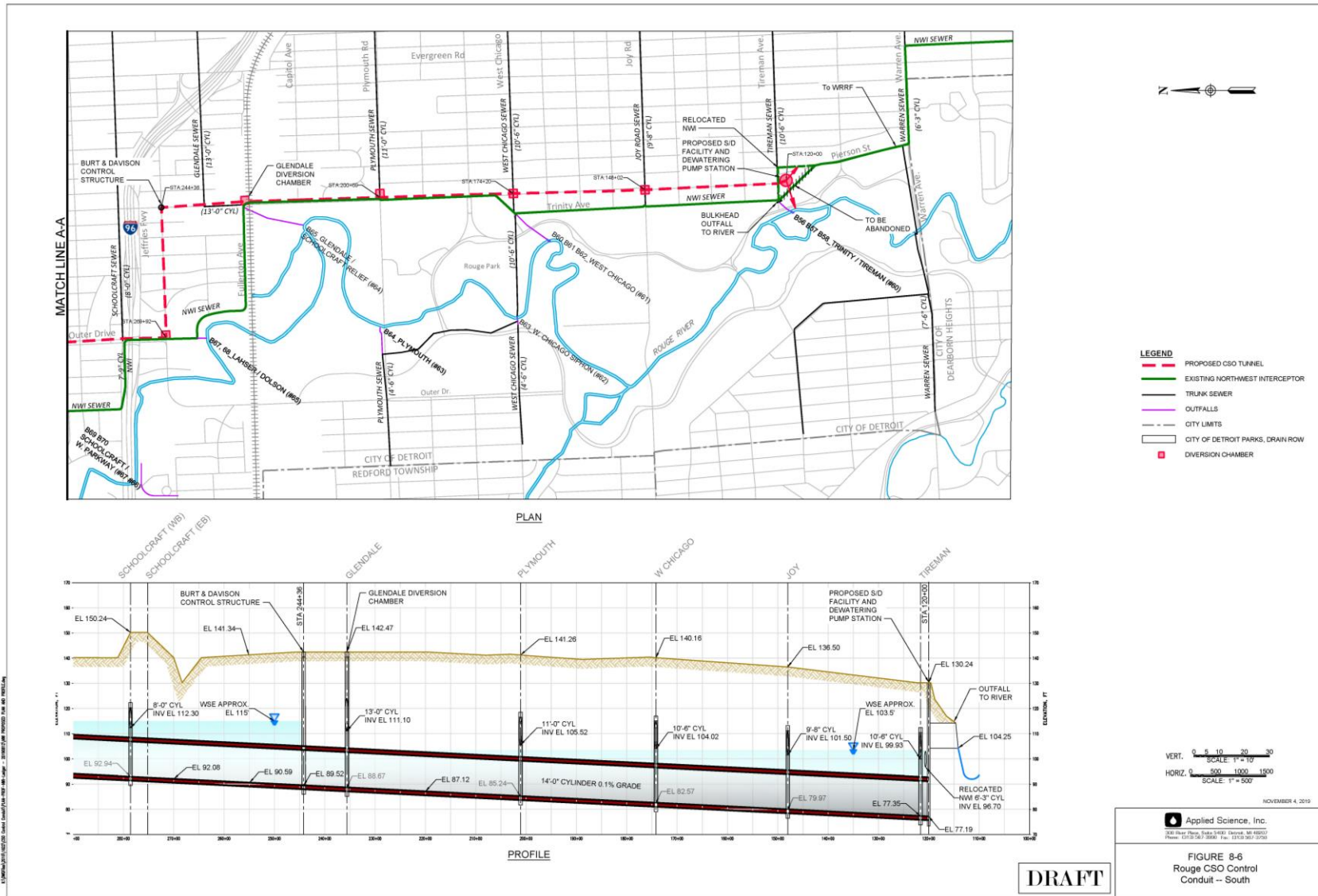

Figure 8-6. Rouge CSO Control Conduit -- South

Table 8-4. Proposed Overflow Structure Summary

Location	Overflow Weir Length (ft)	Overflow Weir Elevation (ft)
Pembroke	100	616.5
Seven Mile	100	611.6
Six Mile	100	607.9
Puritan	20	609.8
Fenkell	20	605.0
Lyndon	20	603.9
Schoolcraft	100	595.9
Glendale	200	591.4
Plymouth	100	590.4
W. Chicago	100	590.2
Joy	100	585.9
Trinity	100	585.9
Tireman	100	585.9

A typical overflow structure concept is shown below in Figure 8.9. The overflow weir elevations at each structure were set to work in conjunction with the ISDs in order to maximize the existing in-system storage in the trunk sewers before overflow in wet weather would occur. Stop logs/gates can be used to divert dry weather flows into the CSO Control Conduit.

At some locations, the ISD upstream target levels can be increased once the CSO Control Conduit was put in-service. The following preliminary ISD adjustments are proposed:

- Trinity and Tireman (on the NWI) increased to the pipe crown,
- Tireman and Trinity (on the Tireman sewer) increased to the pipe crown, and
- Pembroke and Berg raised one foot.

The CSO Control Conduit will provide some redundancy for the NWI. Dry weather flows may be diverted into the CSO Control Conduit and conveyed to the downstream end if the NWI requires repairs. The dry weather flows diverted into the CSO Control Conduit will be pumped into the NWI. Therefore, it is expected that it only be used during repairs or emergency situations.

Based on the RCWS model results for 2018 monitoring period, overflow is predicted to occur three (3) times in a seven (7) month period with the new ISDs, some sewer separation and the CSO Control Conduit in-place.

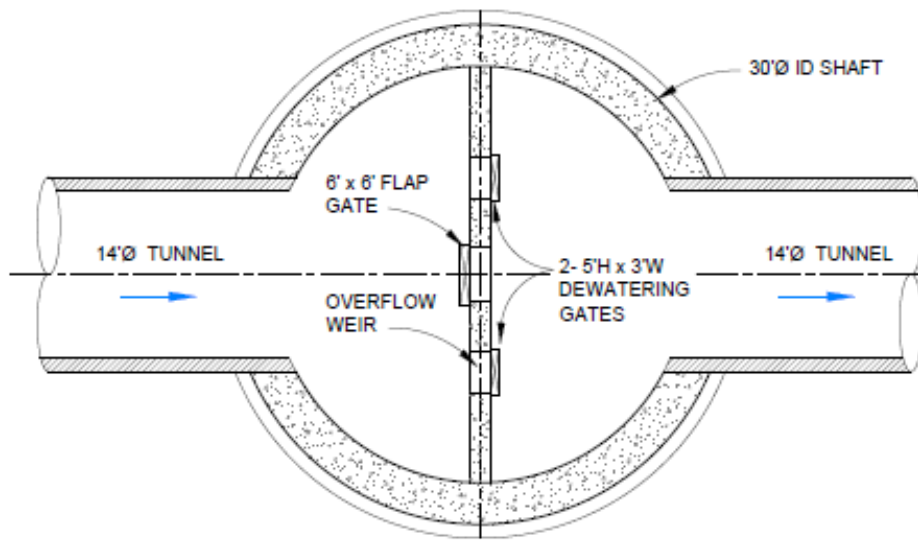

PLAN VIEW

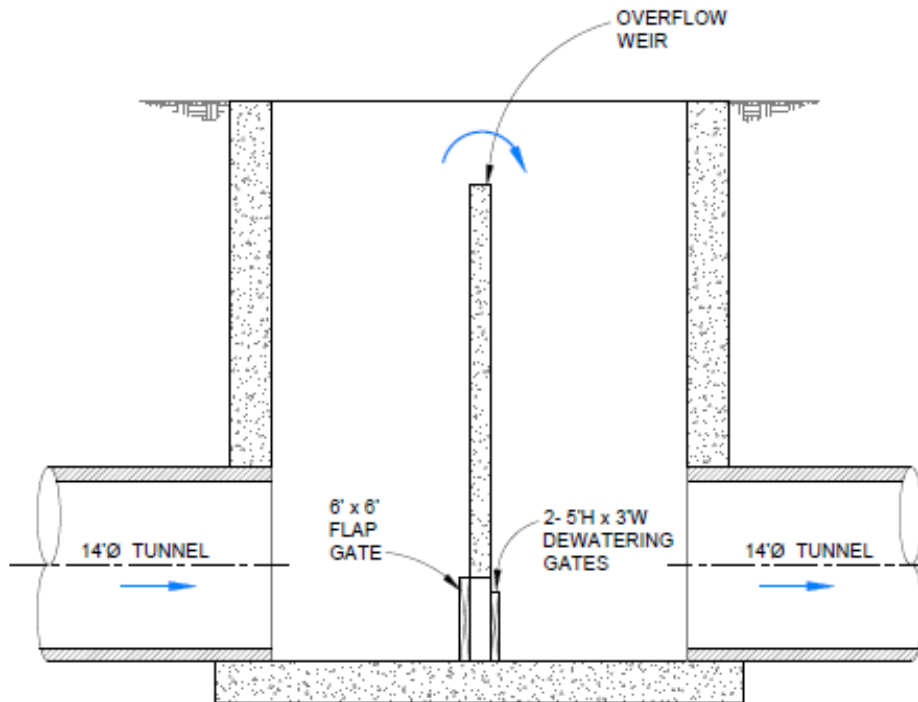

PROFILE VIEW

Figure 8-7. Typical Control Structure

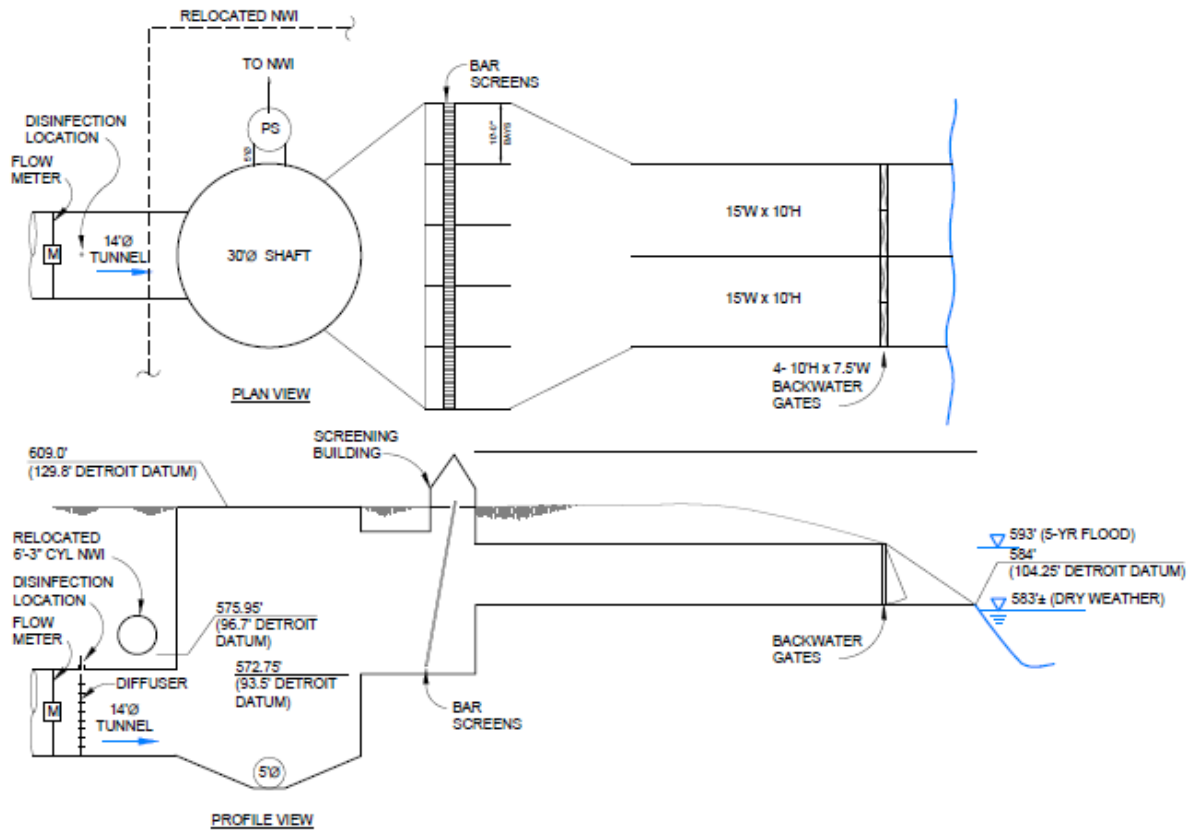

Figure 8-8. Downstream Screen and Disinfection Facility

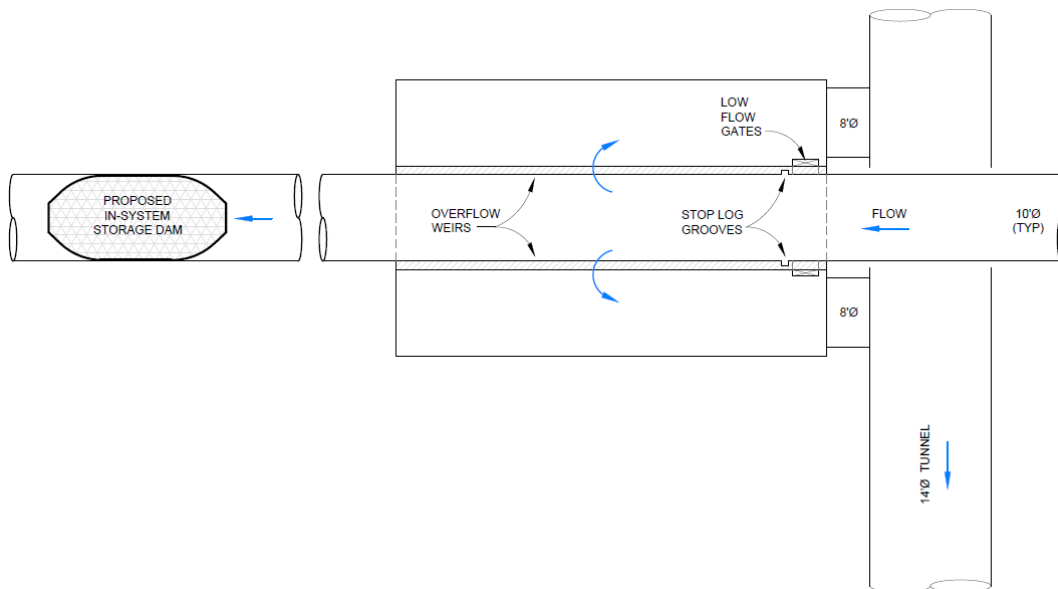

Figure 8-9. Typical Overflow Structure

8.4.3 Phase 3 CSO Netting and In-Line Disinfection

CSO outfall netting and in-line disinfection is proposed for any remaining outfalls that continue to discharge at frequencies and volumes that exceed the NPDES criteria for Limited or Extreme Event classification. CSO outfall netting is proposed for four outfalls in Phase 1: B-020, B-023, B-029, and B-036. GLWA will develop operating experience with net technology during Phase 1 and Phase 2. See Technical Memorandum 6A for more information on proposed CSO netting facilities.

The City of Dearborn is proposing to implement in-line disinfection for its CSO 013/014 CSO screening, disinfection and first flush capture facility. The operation experience of the City of Dearborn will be valuable to GLWA when it plans for Phase 3 in-line disinfection.

In-line disinfection systems require complex operating procedures to meet standards for bacteria reduction and total chlorine residual. In-line disinfection systems also require the construction of geographically distributed structures for chlorine injection, chemical storage, and residual monitoring. Consequently, operation and maintenance costs are significant and O&M activities have impacts in neighborhoods in which facilities are located. For these reasons, in-line disinfection is proposed for a limited number of locations after other control technologies and optimization have been applied.

8.5 Hub Utility Programs

The proposed “Hub Utility” programs include leadership of the Regional Operating Plan, maintenance and of the Regional Wastewater Collection System Model, implementation of the Regional Water Quality Monitoring Program, facilitation of Tier 1 and Tier 2 Member Collection System and MS4 Best Practices, and long term coordination with the Michigan Department of Transportation and the Detroit Water and Sewerage Department regarding sewer separation and removal of highway stormwater from the combined sewer system. The goals of these Hub Utility programs are described in this Section. In Section 9, there is further discussion of how these programs will drive the implementation of this Wastewater Master Plan.

8.5.1 Regional Operating Plan

The goal of the Regional Operating Plan is to improve the performance of the regional collection system through new tools for real time controls, regional pre-storm planning, post-storm event analysis, a regional storage dewatering plan, and the use of the Regional Wastewater Collection System Model in conjunction with SCADA data from the GLWA and Member operations. Development of the Regional Operating Plan is described in the report “Optimization of Regional Operations”, which is a part of this Wastewater Master Plan. A separate report “Regional Operating Plan” provides the essential information regarding regional operations that is intended to be referenced in future NPDES permits for GLWA and its Members.

8.5.2 Regional Wastewater Collection System Model

A new Regional Wastewater Collection System (RWCS) Model was developed as part of the Wastewater Master Plan project. This is a SWMM Version 5 hydrologic and hydraulic model that updates the former Greater Detroit Regional Sewer System (GDRSS) model and extends it with new, more detailed models of Detroit’s West Side and GLWA Member models. Receiving water quality models were developed to be used in conjunction with the RWCS model, so that CSO and

stormwater loadings can be analyzed by water quality impact. Development of the RWCS and associated receiving water quality models is described in Technical Memorandum 4A, 4B, 4C, and 4D.

GLWA has provided the RWCS model for use in other major projects, including MDOT highway improvement projects and the DWSD Collection System Modeling project, that impact wastewater and stormwater in its regional service area. It is anticipated that the RWCS model will continue to be shared with other parties to coordinate regional planning, and that the RWCS model will be continually improved with more detailed representations of new wastewater and stormwater infrastructure.

8.5.3 Regional Water Quality Monitoring

GLWA is committed to leading regional efforts to protect its receiving waters by controlling CSO and SSO discharges, fostering green infrastructure and MS4 compliance, and increasing resource recovery and operational efficiency at the WWRF. Development of a regional water quality monitoring program for all major receiving waters will demonstrate and quantify the benefits of these efforts, identify long term trends, inform regional investment priorities, and provide value in public education and outreach.

The proposed comprehensive water quality monitoring program will further advance regional water quality goals to measure progress and identify remaining impairments by characterizing ambient conditions and long-term trends. The program is intended to be collaborative, with cooperating partners such as the USGS, GLWA Members, EGLE, and watershed groups contributing funding and resources. The monitoring program will work in concert with water quality modeling tools. Together, monitoring and modeling will provide GLWA and Members with cause and effect insights to support progressive, adaptive, and cost-effective compliance strategies that are directly aligned with regional water quality conditions and goals.

GLWA service area receiving waters include the Clinton River, Lake St. Clair, the Detroit River, and the Rouge River. A detailed discussion of the Regional Water Quality Monitoring Program is presented in Technical Memorandum 6A. Locations for monitoring sites are shown in Figures

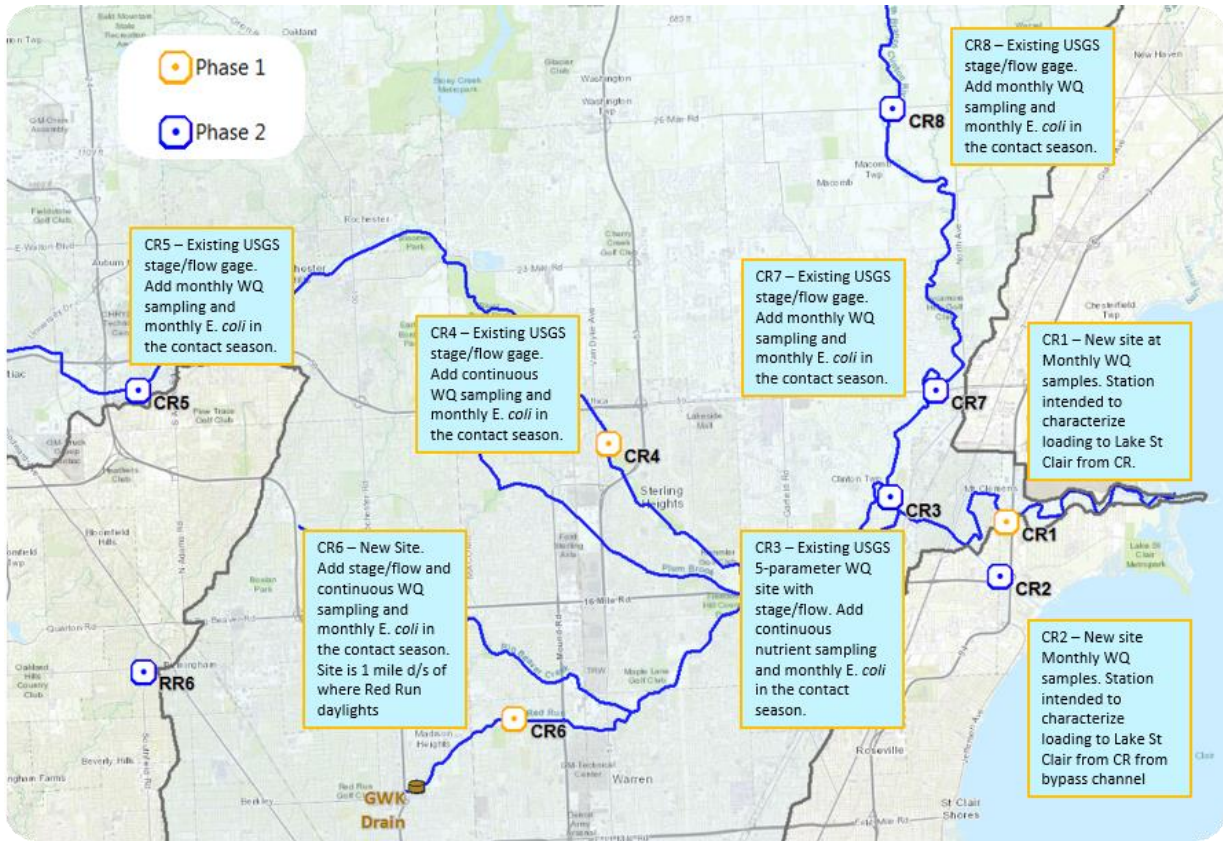

Figure 8-10. Clinton River Water Quality Sampling Sites

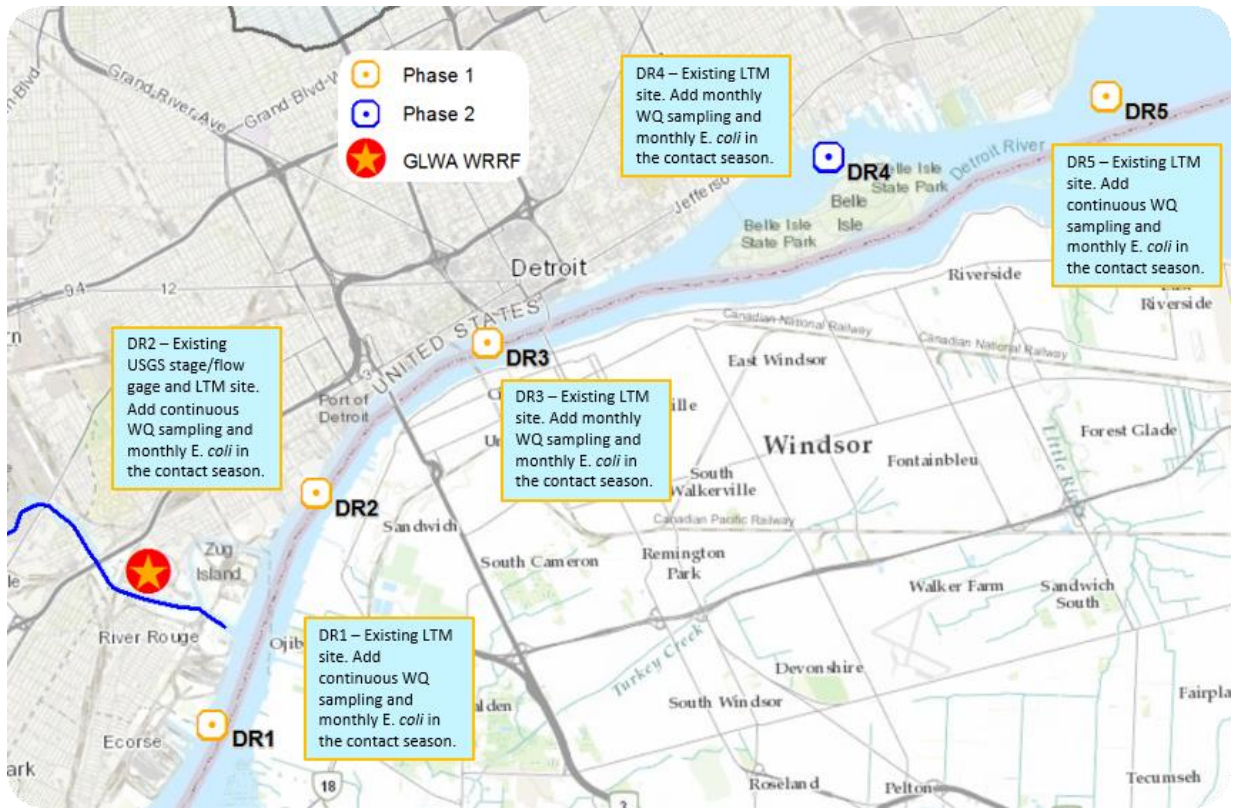

Figure 8-11. Detroit River Water Quality Sampling Sites

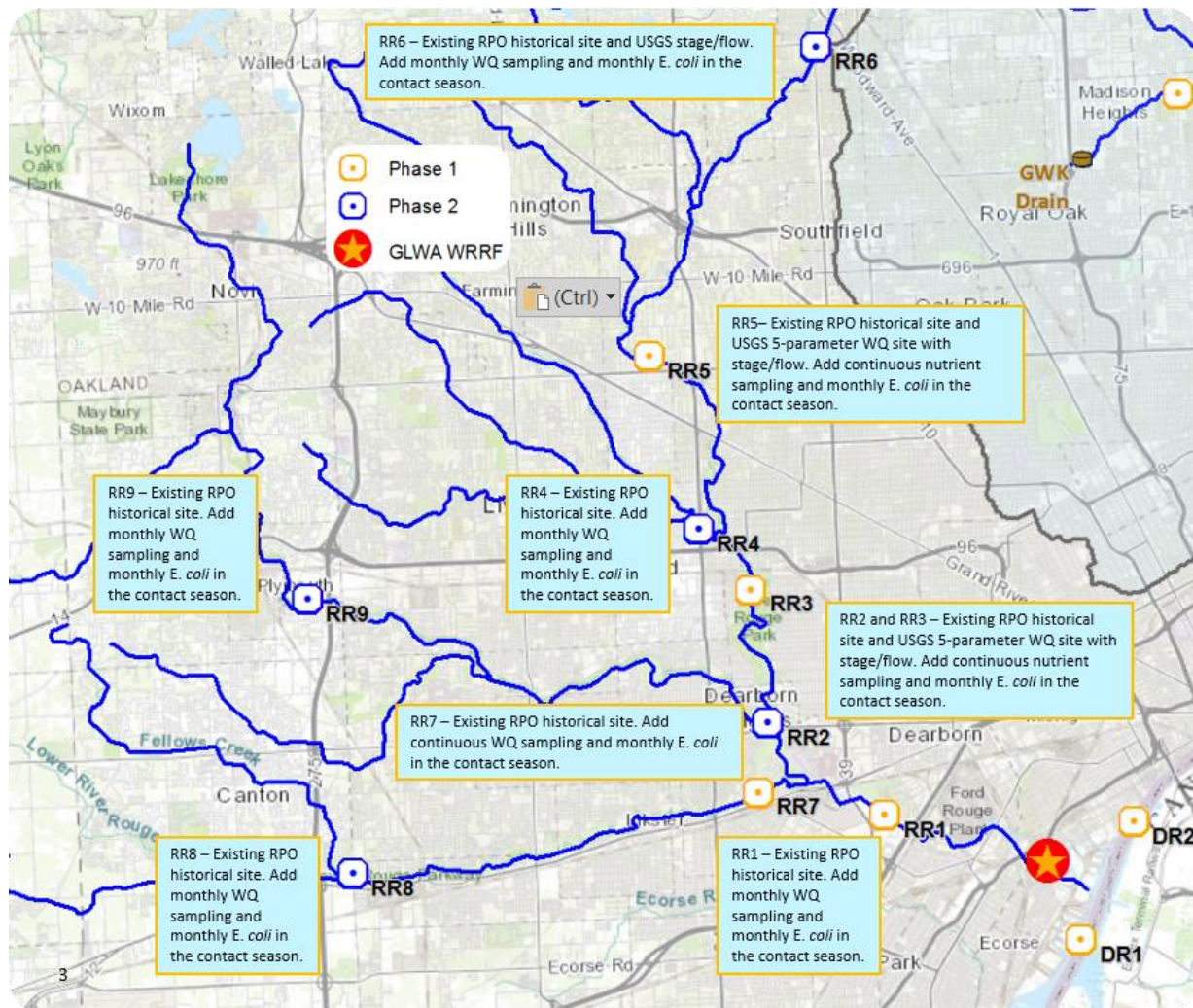

Figure 8-12. Rouge River Water Quality Sampling Sites

8.5.4 Collection System and MS4 Best Practices

The Collection System and MS4 Best Practices Program is a proposed new initiative for GLWA and its Members. This new program is designed to leverage GLWA’s “Hub Utility” role and its One Water Partnership to guide all Members (first and second tier) to apply best practices for wastewater collection system and separate storm water system inspection and maintenance.

This GLWA program is designed to complement the proposed new Contributing Municipality Collection System General Permit to be implemented by Michigan EGLE in 2020. The new General Permit applies to separated sanitary sewer systems that discharge to a wastewater treatment plant not owned by the municipality and have been determined by Michigan not to need an individual NPDES permit. The new General Permit establishes requirements for:

1. Proper Operation and Maintenance

2. Asset Management Program Requirements
3. Capacity and Management Requirements
4. Inspection Frequency
5. Fiscal Responsibility
6. Submittals and Reporting

Another related initiative in 2020 will be Michigan House Bill 4100 to enable the creation of stormwater utilities in the state. Enactment of this legislation would provide additional institutional and funding resources for GLWA Members which elect to form a stormwater utility to improve flood protection and stormwater quality.

The GLWA Collection System and MS4 Best Practices Program is proposed to be implemented starting in 2020 through a new collaborative workgroup of GLWA Members tentatively called the “Watershed Work Group”. Initial activities of Collection System and MS4 Best Practices Program are proposed to include:

1. Annual voluntary reporting of inspections, maintenance, sewer cleaning, catch basin cleaning, infiltration/inflow studies, and rehabilitation.
2. Development of a pilot program to identify cost-effective improvements to regional practices that will improve dry weather water quality.

The proposed form and initial set of content questions for the annual voluntary reporting of collection system and MS4 best practices is presented Tables 8-5 to 8-7. The annual survey is intended to be an on-line form with a database so that previous year information that remains applicable does not need to be re-entered. The 5-year assessments of system performance discussed later in this section would include summary level progress on Member Collection System and MS4 Best Practices.

Table 8-5. Preliminary Annual Self-Reporting Form: Inventory of Existing Collection System and Storm Sewers

Member Name: _____			
Reporting Period: July 1, 2020 to June 30, 2021			
Inventory	Asset Type	Unit	Quantity
	Tributary Street Length	Feet	
	Sanitary Sewer Length (4' diameter and less)	Feet	
	Sanitary Sewer Length (over 4' diameter)	Feet	
	Combined Sewer Length (4' diameter and less)	Feet	
	Combined Sewer Length (over 4' diameter)	Feet	
	Separate Storm Sewer Length (4' diameter or less)	Feet	
	Separate Storm Sewer Length (over 4' diameter)	Feet	
	Service Connections	Number	
	Service Connections with Footing Drains	Number	

Member Name: _____			
Reporting Period: July 1, 2020 to June 30, 2021			
Inventory	Asset Type	Unit	Quantity
	Catch Basins	Number	
	Manholes	Number	
	Pump Stations	Number	
	Retention Treatment Basin	Number	
	Sanitary Retention Basin	Number	
	In-System Storage Devices	Number	
	Emergency Gates	Number	
	Regulator and Backwater Gates	Number	
	Permitted Combined Sewer Overflows	Number	
	Permitted MS4 Stormwater Outfalls	Number	
	Critical HGL Relief Points	Number	
	Percentage of Sewers with NASSCO PACP Ratings	Percentage	
	Percentage of System Documented in GIS	Percentage	
	Percentage of System Maintained in CMMS	Percentage	

Table 8-6. Preliminary Annual Self-Reporting Form: Practices for Capacity Management Operation and Maintenance

Member Name: _____			
Reporting Period: July 1, 2020 to June 30, 2021			
Preventive Maintenance	Activity Type	Unit	Quantity
Inspections	Manholes	Number	
	Sewers	Feet	
	H ₂ S Corrosion	Feet	
	Regulators and Backwater Gates	Number	
	MS4 Outfalls Inspected	Number	
	MS4 Outfalls Sampled	Number	
Cleaning	Catch Basins	Number	
	Sewers	Feet	
	Sanitary Retention Basins	Number	
	Retention Treatment Basins	Number	
	Volume of Material Removed	Cubic Yards	
Investigations	Infiltration/Inflow	Sq. Miles Studied	
	Excessive I/I Criteria	Gallon/Person/Day	
	Area with Excessive I/I	Square Miles	

Member Name: _____			
Reporting Period: July 1, 2020 to June 30, 2021			
Preventive Maintenance	Activity Type	Unit	Quantity
Corrective Activity	Activity Type	Number	
	Blockages Removed	Number	
	Collapses and Sink Holes Repaired	Number	
	Vandalism and Other Repairs	Number	
	Emergency Repairs	Number	
	SSO Volume Reported to EGLE	Million Gallons	
	Manhole Lining	Number	
	Sewer Lining	Feet, Type, Diam.	
	Sewer Replacements	Feet, Type, Diam.	

Table 8-7. Preliminary Annual Self-Reporting Form: New Facilities for Capacity Management Operation and Maintenance

Member Name: _____			
Reporting Period: July 1, 2020 to June 30, 2021			
	Activity Type	Unit	Quantity
	Sewer Extensions	Feet	
	New Pumping Stations	Number	
	New Service Connections	Number	

The preceding information is proposed to be submitted digitally. An online data base would be created for Members to enter the information once, then provide annual updates. The online data base would include reporting features to summarize annual CMOM activity by GLWA Members.

8.5.5 Stream Debris and Obstruction Removal

Stream debris and obstructions, including log jams and woody debris, have impacted hydraulic conditions on portions of the Rouge River and Clinton River in the past and continue in the present. On the Rouge River, there are significant dry-weather flow impacts on channel hydraulics. The largest impacts during wet-weather are at bridges where the log jams can stretch both sides of the channel and bridge abutments. A major woody debris management program was performed on the Clinton River in 2007.

It is possible that GLWA will consider actions in collaboration with other organizations to clear some of the log jams on the Rouge River in the coming years. GLWA may have limited jurisdictional authority for stream debris removal and will need to facilitate actions by those agencies with

authority. As such actions occur, they will be discussed with the ROP Leadership Team, and future versions of the ROP could be updated accordingly.

Stream debris and obstruction removal is important for release of wet weather flows from combined sewer systems, prevention of collection system back-ups, stream mixing and natural assimilation of wet weather discharges, and local ground surface or roadway flooding.

8.5.5.1 Large Woody Debris Management in River Corridors

This section presents a survey of current practice for Large Woody Debris (LWD) management in river and stream corridors. This survey of current practices is intended to provide GLWA and its Member with guidance as an LWD management plan is developed for targeted river reaches in the GLWA service area.

LWD, sometimes referred to as log jams or debris dams, is the buildup of logs, sticks, and sediment along the edges of streams. In recent years, many agencies across the country have moved away from completely removing LWD from rivers and streams and are moving towards environmentally friendly management techniques. Recent studies have found that LWDs have multiple benefits by helping to reduce erosion and providing habitats for fish and wildlife. However, if a log or debris jam becomes large enough, it will have a negative impact on the flow and shape of the river. Therefore, proper maintenance of LWD is important to the health of the river and nearby infrastructure.

8.5.5.1.1 LWD Removal and Maintenance Practices

While many agencies are moving away from completely removing LWD from rivers, they all follow the same methodologies for removing log jams. The Massachusetts' Clean Water Tool Kit for Woody Debris Management emphasizes the need for a plan that documents the existing conditions of both the channel and the obstruction. The plan should also include access points, the size of logs being removed, the location for where removed debris will be placed, and the permits required.

To determine if permits will be required, the City of Rochester Hills', *A Primer on LWD Management* gives a general rule of thumb that if "any activity that does disturb the streambed and bank or places a new structure in the floodway (including an LWD structure) does require a MDEQ permit." Therefore, if the removal plan includes logs embedded in the streambank or bottom, a permit will be required. Removal plans that include the use of heavy equipment will likely also require a permit.

Subsequent communications with EGLE indicated that a permit would not be required if the removal action is not disturbing the bottom. Cutting off logs at the bottom of a stream is a potential method to avoid permitting in some situations. Case by case decisions should be made in conjunction with representatives of EGLE.

The Clinton River Watershed's Field Manual on Maintenance of LWD recommends that the physical removal of accumulated woody debris begins on the upstream side with the smaller pieces. Once those have been removed and properly disposed of, the larger logs should be cut into manageable pieces and moved to a predetermined location. This location should be outside of the river bank's full channel and far enough away that future storms do not move it back into the river. Once all the larger logs have been removed, the trash and smaller debris should be properly disposed of offsite.

For LWD that does not require removal, the Riparian Corridor Management Technical Advisory Committee developed *The Woody Debris Management 101: Clean and Open Method Guide*. The step by step preventative maintenance guide focuses on removing trash and creating an opening for water to more easily flow through LWD. This methodology was designed such that no permit is required, and volunteers can do the work in groups of two.

The Clinton River Watershed’s Field Manual on Maintenance of LWD includes several preventative maintenance guides. Future flooding and erosion issues may be prevented by reorienting or anchoring existing LWD. These practices have the potential to disturb the river bank and a permit may be required for these scenarios.

Structural countermeasures are another approach used by many agencies to minimize debris accumulation and improve maintenance operations. Structural measures include features to intercept and collect debris, deflectors to minimize the potential of clogging, and systems to orient the debris in the flow stream to facilitate passage through a structure.

8.5.5.1.2 When to Perform Maintenance

As woody debris is an important component to a river’s health, it should not be removed without an assessment of how each structure is affecting the river. The Massachusetts’ Clean Water Tool Kit recommends that “the actual removal [of LWD] should be the last resort” due to the benefits they are providing to the river. They recommend that LWD should be removed only if it has the potential to cause serious flooding, erosion, or a biological impact to a stream.

It can be difficult to look at an LWD structure and determine if it is going to create flooding or have a negative biological impact. To help determine when LWD should be managed, the Southeast Michigan District staff at EGLE put together an informal flow chart. The flow chart indicates that any naturally occurring wood

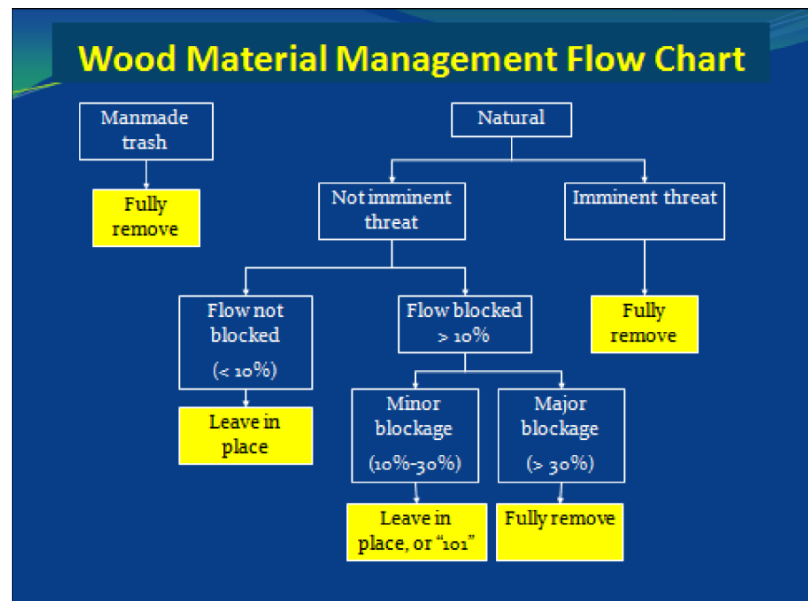

Figure 8-13. Decision Chart for LWD Management

material that causes an imminent threat should be fully removed from the river. Examples provided of imminent threat included “erosion that threatens someone’s house or a major jam on the upstream side of a bridge that could result in bridge failure.”

The flow chart also recommends preventative maintenance should be taken for when LWD is blocking more than 30% of the stream bed. When the flow is not significantly reduced or the LWD is a minor blockage, little maintenance or the Clean and Open method is recommended. The term “101” refers to an instructional course by Michigan DNR called “Woody Debris Management 101” that advocates for minimalist approaches to handling minor stream blockages.

The Northeast Ohio Regional Sewer District (NEORS) has a robust program to assess and maintain the open channel drainage system. In general, debris is removed when the percent blockage is greater than 25% or when streamflow is negatively impacting (or threatening) other infrastructure. This includes debris causing a backwater effect to a local outfall. NEORS conducts physical condition assessment of high priority areas after major storm events and is starting to use hydrologic/hydraulic model results in sensitive areas to refine their decision framework.

The need for maintenance can also be determined using the definition of a “mass of wood debris.” The Indiana DNR Regulatory Guide for Removal of a Logjam or a Mass of Wood Debris from a Floodway, defines mass of wood debris as an “accumulation of lodged trees or other wood debris that is any of the following:

1. Causing or threatening to cause flooding on a road or private property.
2. Impeding navigation by a boat.
3. Reducing the capacity of a waterway to transport water.

These scenarios can be used in tandem with the flow chart to determine if maintenance or removal is required. The Ohio DNR recommends maintenance and debris removal be performed “during low flow periods, which typically occur late summer, autumn and winter.” They also recommend that stream inspections should happen twice a year and after large storms. This will help develop an inventory of woody debris on the river and record what type and how quickly materials are accumulating.

For log jams that occur on private property, the Massachusetts’ Clean Water Tool Kit recommends that the property owner be asked if they share a similar concern about the LWD at their site and if they concur with any maintenance that needs to be performed. In Indiana and Ohio, the responsibility of log jam removal is for the most part, left to the landowners. Unless the obstruction is located on property owned by the DNR or if the obstruction is threatening a bridge, no department has the jurisdiction to remove log jams. In these states, watershed and volunteer groups have developed programs to manage woody debris, however finding adequate funding for these programs can create issues.

8.5.5.2 Potential Funding

Watershed and volunteer groups raise most of their river management funds through grants. The National Fish and Wildlife Foundation and EGLE (formally MDEQ) offer grants that provide funding for projects focused on enhancing habitats and volunteer based clean ups. The grant programs tend to be highly competitive but also very helpful in cleaning up rivers. A successful log jam removal on Deer Creek, was funded by the Lake and River Enhancement (LARE) Program Grant Program put together by the Indiana DNR.

Another possible form of funding could be generated using the State of Michigan Drain Code (Act 40 of 1956). Under the Drain Code, routine maintenance such as woody debris removal may be performed and assessed to the land owners in the drainage district. The Drain Code only applies to designated county drains; drains become designated through a petition process.

An example of using the Drain Code can be found on the Looking Glass River. A portion of the river was established as an intercounty drain in 1886 and the drainage district to the river was delineated. The Clinton Conservation District's FAQs indicate that maintenance costs for this portion of the river will be assessed to "those who benefit from the existence and operation of the drain" including MDOT, railroads, and landowners in the drainage district in accordance with the Michigan Drain Code. The Drain Code also limits the cost of maintenance to \$5,000 per mile of drain per year.

Regional sewer districts such as the Northeast Ohio Regional Sewer District (NEORS) and Milwaukee Metropolitan Sewerage District (MMSD) both have jurisdiction or responsibility of open channels rivers in their regions. Therefore, they are able to use their money to fund debris removal projects along their rivers. Specifically, NEORS implemented a stormwater fee in their region where the revenue from the fee is used to address flooding, erosion, and water quality throughout the region's streams and rivers.

There are also funding options available for studies of the flood plain. The US Army Corps of Engineers offers a program called Planning Assistance to States (PAS). This program provides money to state and local governments to fund flood impact studies. These studies would be helpful in determining where LWD maintenance is crucial and could also be used to start setting up an inventory of LWD. The Corp can be involved in flood risk reduction and ecosystem restoration projects infrastructure improvement projects when funding is appropriated through Congress.

8.5.6 Use of Metering and Modeling for Estimating CSO Volumes

8.5.6.1 Introduction

Wastewater utilities with combined sewer systems are required to report combined sewer overflow (CSO) discharges under the NPDES permit program to applicable regulatory agencies. The requirements for reporting CSOs vary by municipality and state regulatory agency. This section documents the way that utilities address the regulatory reporting requirements including how they develop or measure estimates of CSO discharge and quality assurance practices applied prior to submittal to the regulators.

CSO outfalls are generally located at complex regulating structures bordering receiving waters. These conditions can lead to variability in backwater-impacted flow conditions. If the regulatory requirements require only monitoring activation and duration statistics, monitoring may provide more accurate results as compared to use of a hydraulic model. If discharge volumes are also required, then hydraulic models may be useful, especially where accurate estimates of cross-sectionally averaged velocity or weir flow estimates cannot be reliably obtained with monitoring equipment.

Two approaches have generally been used for estimating overflow volumes for regulatory reporting: direct measurement of discharges and predicted estimates using a hydraulic model. Both approaches (monitoring and modeling) can be and are used to report discharges to regulatory agencies. In smaller systems, it may be more cost-effective to directly monitor a few outfalls as opposed to implementing and maintaining a hydraulic model for reporting purposes. In contrast, large systems with many outfalls and advanced modeling resources may be better handled with modeling in combination with monitoring. New cloud-based information technology enables

hydraulic models to operate in near real-time with SCADA systems, and this creates a new technique called “digital twinning” that can be used for continuous improvement to CSO volume estimates.

The following sections present case studies of the use of modeling and metering for CSO volume estimates. After the case studies, the development of digital twin technology for GLWA is presented.

8.5.6.2 Case Studies

Toledo, Ohio

The City of Toledo operates a combined sewer system that covers approximately 11,300 acres and 27 combined sewer discharge points. The City maintains a hydraulic model that covers the combined and separate sanitary sewer system. The model includes all known outfalls and have been calibrated to temporary flow metering efforts. The City also maintains a complex supervisory control and data acquisition (SCADA) system level sensors or depth/velocity meters at each combined sewer outfall to detect when CSO activity occurs and quantify the volume, frequency and duration of discharge. At CSO outfalls using level sensor technology, the CSO discharge is calculated from a depth measurement over a weir. At locations that are influenced by elevated river levels, a depth/velocity meter is used to calculate CSO discharge.

The City reviews data in the SCADA system to confirm the validity of the overflow data. The overflow data is compared to a series of permanent rain gauges to confirm that recorded overflow data was valid. If anomalies occur, the site is visited by operations and maintenance staff to confirm if maintenance is required. If the data is determined to be valid, it is reported to the State of Ohio on a monthly basis. The overflow data are also available to the general public via the Toledo Waterways Initiative website.

Metropolitan Sewer District of Greater Cincinnati, Ohio

Metropolitan Sewer District of Greater Cincinnati (MSDGC) operates a wastewater collection and treatment system that provides service to more than 850,000 residents and business across 290+ square miles. MSDGC maintains approximately 3,000 miles of sanitary and combined sewers and operates seven major wastewater treatment plants, more than 100 pump stations, two package treatment plants and several high-rate treatment facilities. Approximately 160 million gallons of wastewater is treated daily.

The City maintains an extensive remote sensing program for the wastewater collection system that includes approximately 600 level sensors and depth/velocity meters. Each CSO discharge point is monitored via a depth or depth/velocity sensors. The City maintains two types of hydraulic models for the combined sewer system. The System-Wide Model (SWM) is a comprehensive hydraulic model that represents flows from all part of the combined and sanitary sewer system. MSDGC also maintains simplified hydraulic models for each combined sewer regulator. The simplified CSO models include a detailed representation to the local regulator hydraulics and have been calibrated to available data.

The simplified CSO models are used for regulatory reporting purposes. MSDGC has developed a system that links the CSO models to ground-truthed radar rainfall data to automatically run each model and generate CSO statistics.

MSDGC maintains multiple contracts with vendors to maintain the flow and level metering equipment. MSDGC's data collection system includes alerting to identify when meters have been damaged or require maintenance. MSDGC also contract with a third-party provider of radar rainfall data to provide accurate spatially distributed rainfall data across the service area.

MSDGC also sponsors a CSO notification program to alert Hamilton County residents when existing or predicted weather conditions are likely to cause CSOs into local creeks and rivers, or sewer backups into buildings. MSDGC issues alerts when a rainfall of 1/4 inch or more is predicted or recorded for Hamilton County, or when water levels in area rivers and streams are elevated.

Louisville and Jefferson County Metropolitan Sewer District, Kentucky

The Louisville and Jefferson County Metropolitan Sewer District (MSD) provides sanitary, drainage, and flood protection services for the Louisville Metropolitan area in Kentucky. MSD currently operates and maintains the sanitary and combined sewer system located in Jefferson County and small areas in Oldham County, Kentucky. The sanitary sewer collection system includes over 3,200 miles of sewers, over 60,000 manholes, and nearly 100 CSO locations.

MSD maintains a network of flow and level instruments throughout the sewer system and each CSO is monitored using either a level sensors or flow meter. Data from these instruments is collected in near real time utilizing wireless technology. The collected data is populated to a database which is programmed to generate overflow reports for illicit discharge notification to the Kentucky Department of Water. Data verification is accomplished utilizing both manual and automated methods typically based on site configuration to establish criteria for when an overflow may occur (i.e. level above that of the weir, gate position, redundant instrumentation, ...) Discharge volumes are established based on measured or calculated flow rates depending on the data available at a given site. During flood events, flood gates may be closed to prevent river water intrusion to the combined sewer system. In this situation, Flood Pump Stations are utilized to discharge excess flow volumes to the river to prevent surface and residential flooding. Overflow volumes are then calculated utilizing Flood Pump Station data collected via the MSD SCADA system.

MSD also provides public notification of overflow via their website and customers can sign up to receive these notifications directly.

Sanitation District 1 of Northern Kentucky

Sanitation District 1 of Northern Kentucky (SD1) operates a mixed combined and separate sanitary sewer collection and treatment system. SD1 maintains a hydraulic model of the collection system that has been calibrated to available flow metering data. SD1 use the hydraulic model to simulate observed rainfall data from permanent rain gauge network to quantify CSO and SSO statistics for regulatory reporting.

SD1 implements a rigorous field investigation program to inspect CSO discharge locations following potential overflow events. The field investigation data are used to validate model overflow predictions for reporting purposes.

Metropolitan District Commission, Hartford, Connecticut

Hartford MDC has monitored all of its CSO outfalls since 2002. The MDC's 2012 LTCP Update report the following: *"The District also installed an Overflow Alarm and Monitoring System, which continually measures depth at the 83 active CSO and all active SSO regulators... This system is an excellent tool for monitoring the operation of the CSS and helping to diagnose surcharge issues. The meters can identify when an overflow occurs by measuring depth of flow compared to the height of the weir or overflow pipe. The majority of the meters were installed in 2002, with additional monitoring sites added more recently to monitor structural SSO regulators in West Hartford, Newington and Windsor..."*

The monitoring system reports depth in sewers and outfalls. CSO volume is calculate via rating curve equations, and many of those equations have been refined using the results of SWMM modeling. Efforts to improve the consistency of model and metering results have led to improvements in the fundamentals of the SWMM model. For example, SWMM recently added an option to have a weir coefficient vary with depth, which is important at very low flow depths.

New York City

New York City performed a study of the accuracy of CSO metering in 2015. (<http://mcwrs.org/Documents/WERF2P13%20%20NYCDEP%20CSO.pdf>). The study concluded:

"NYCDEP has not found the system to be reliable enough for automated, real-time use. However, NYCDEP has found that installation of temporary flow monitoring systems is insightful when combined with calibrated hydraulic models and existing telemetry. The resulting comparative analysis provides a holistic look at the CSO drainage area and allows for a better understanding of the inter-relationship between drainage area characteristics and overflow discharge volumes."

Some of the problems they identified were due to tide and the difficulty in accurately metering over a wide range of flows, and labor and costs for meter inspection and maintenance.

Massachusetts Water Resources Authority

The Massachusetts Water Resources Authority (MWRA) reports CSO annually based on a mix of modeling and metering. The model is updated annually based on system modifications, permanent metering in key sewers, and temporary metering. The MWRA's 2018 report is presented at this link: <http://www.mwra.com/cso/annual-discharge-estimates/cy2018.pdf>

Gary Sanitary District, Indiana

The Gary Sanitary District (GSD) in Indiana has traditionally used monitoring to measure and report CSOs. In recent years, GSD has moved to a hybrid approach of using their collection system

SWMM model to develop a CSO discharge curves to estimate CSO volume discharged at each outfall based on rainfall event characteristics. This methodology entails the following steps:

- CSO discharge hydrographs were simulated at GSD CSO outfalls using the model for a multi-year period to include a wide variety of rainfall event characteristics.
- For each CSO outfall, regressions were developed comparing various rainfall statistics and resulting CSO volume discharges and durations, including rainfall characteristics such as event duration versus average intensity, total rainfall depth versus peak intensity, and total rainfall depth versus rainfall duration.
- Based on the information developed above, a user-friendly table was developed that enables GSD staff to efficiently look-up rainfall statistics and to estimate the volume of CSO discharge for each CSO outfall as a result of rainfall events characteristics.

8.5.6.3 Digital Twin Technology for GLWA

During the period March to June 2020, the Wastewater Master Plan project team worked with GLWA to develop a “digital twin” of the regional collection system. The concept of a “digital twin” was first introduced to industry and utilities at the Society of Manufacturing Engineers Conference in 2002 in Troy, Michigan. A digital twin, in the context of a wastewater utility with combined sewers, starts with a model representation of the infrastructure assets for conveyance, outfalls, pumping, and flow controls structures of the collection and treatment system, as well as the hydraulic boundary conditions of the receiving waters.

The Regional Wastewater Collection System (RWCS) Model, developed using SWMM hydrologic and hydraulic model, is used as the model of the infrastructure assets. The RWCS SWMM model in December 2019, was comprised of 15,803 conduits, 1,606 hydraulic structures, 237 pumps, and 4,418 sub-catchments.

The other aspect of the digital twin is representation of the factors that influence the regional model. These factors include wastewater flows, rainfall and weather conditions river levels drivers that influence the behaviors. The digital twin uses real time data from 3 National Weather Service stations, 36 rain gages, and 64 river stage gauges to drive the model response. The rainfall data is processed by a radar rainfall service over the 944 square mile service area into 1 km square pixels and calculated for each of the 4,418 sub-catchments as a series of 5-minute rainfall depths. The river stage data are used to establish hydraulic boundary conditions for CSO outfalls. In-system storage is imposed during times of high river stage when high river elevations prevent the opening of adjacent back water gates on CSO outfalls.

The data described above are integrated through an Applications Program Interface (API) each night. The performance of the Regional Wastewater Collection System in conveying wastewater to the Water Resource Recovery Facility (WRRF) is greatly influenced by the operating protocols of Pump Station 1 and Pump Station 2 at the WRRF and by the Fairview Pump Station located on Jefferson Street on the east side of Detroit. Accordingly, in the digital twinning process, the RWCS model uses the actual recorded 5-minute data from the GLWA SCADA system for PS1, PS2 and Fairview pump operations in the modeled representation.

Each night the RWCS model is run with the pump station operating records and the rainfall data. The RWCS model results are compared graphically for the preceding 24-hour period to the measured results for wastewater depth and flow, activation of CSO treatment facilities, and operations of in-system storage devices and flow diversion gates. There are approximately 400 points in the regional system where measured to modeled data can be compared for each day and for trend analyses over multiple days or storm events. These points include flow meters, level sensors and critical HGL elevations, pump operations at RTBs, inflatable dam operations, and CSO overflow volumes.

The RWCS Digital Twin is intended to provide GLWA with a tool that compares modeled to measured results for regional system performance. The analysis of model results to measured results over multiple wet weather events will identify parts of the RWCS model that require additional calibration. Conversely, where data for Post Event Reports (PERs) are limited due to available instrumentation measurements, model result can be used to estimate overflow volumes. As GLWA develops experience with the digital twinning tool, there are future applications that could be developed, such as:

- Extension of the modeling to include the river water quality models
- Running future 5-day weather forecasts to assess potential system response
- Simulating multiple versions of the RWCS model, such as an alternative for future improvements, to demonstrate how the future improvements would increase CSO capture during a recent wet weather event.
- Post-construction compliance evaluations typically rely on the use of a hydraulic model to provide a mechanism to index the current system performance to a historical typical period of record. Digital twinning expands the capability of the hydraulic model to include new and existing flow monitoring and water surface elevation measurements into the post-construction compliance evaluation.

The GLWA Member Outreach Portal provides a series of presentations to the Best Practices Work Group and Water Analytics Task Force with results of the digital twinning process in the first half of 2020.

8.6 Regional Collection System Improvements

This Wastewater Master Plan focuses on improvements for CSO and SSO water quality compliance and for long term strategies for resource recovery at the Water Resource Recovery Facility. In parallel with this Master Plan, GLWA was engaged in other projects for condition assessment of its 183 miles of trunk sewers and interceptors, its CSO outfalls, CSO treatment facilities, wastewater pumping stations, and development of a Strategic Asset Management Plan. Information and findings from these concurrent projects were incorporated into this Master Plan.

Table 8-8 presents long term recommendations of the Wastewater Master Plan and proposed continuing points of coordination with asset management and pumping station improvement projects in Phase 1, Phase 2 and Phase 3.

Figure 8-14 presents a summary map showing the general location of projects proposed in this Wastewater Master Plan. Also shown on Figure 8-13 are projects underway and committed projects by GLWA Members that support the desired outcomes of the plan.

Table 8-8. Proposed Plan for Collection System Improvements

	Hub Utility Activities	Asset Management	Level of Service and Redundancy
PHASE 1	Initiate Pilot Phase of the Regional Operating Plan	Implement recommendations of CS-299 CSO Treatment Facilities Condition Assessment	Improve regional hydraulic grade control with construction of the Northwest Interceptor diversion to Oakwood RTB and the Meldrum Sewer diversion to the Leib SDF.
	Facilitate annual self-reporting of CMOM and MS4 activities performed by individual Members. Facilitate discussions with Wayne County Rouge Valley CSO communities Redford, Dearborn, Inkster regarding the scheduling of CSO control investigations based on the findings of this Master Plan.	Reinspect leased trunk sewers, interceptors and outfalls again between 2025 and 2030, then every 10 years, except higher risk sections more frequently Perform trunk sewer, interceptor and outfall rehabilitation based upon pipeline condition assessment findings prioritized by probability of failure and consequence of failure. Existing level of rehabilitation of \$20 million per year is estimated to increase to \$25 million per year during Phase 1.	Implement a phased dry weather flow interceptor redundancy in incremental projects when cost effective relative to rehabilitation or level of service requirements. An initial gravity flow segment is being considered from the DRI to NIEA at West Grand Boulevard as part of DB-226
	Implement Phase 1 of the Regional Water Quality Monitoring Program	Improvements to the Conner and Freud storm pump stations are being studied by others. The WWMP team’s understanding of the project is that improvements to be made to the Freud Sanitary and Storm Pump and Conner Sanitary pump stations have been determined. The Freud improvements are proceeding to design. The Conner Storm pump improvements will be decided after additional physical hydraulic modeling has been completed by 1Q20.	Design the new Conner Sanitary PS to allow for a future change in its discharge condition for discharge to the NIEA. See future improvements related to the Conner Sanitary PS described in Phase 2 and Phase 3

	Hub Utility Activities	Asset Management	Level of Service and Redundancy
		Maintain other pumping stations at existing capacity; perform condition assessments at 10-year intervals and respond to condition assessment needs.	
PHASE 2	Work with Wayne County Rouge Valley CSO communities Redford, Dearborn, Inkster to support in negotiations on NPDES timing for CSO control	<p>Reinspect leased trunk sewers, interceptors and outfalls every 10 years; inspect higher risk sections more frequently</p> <p>Perform trunk sewer, interceptor and outfall rehabilitation based upon pipeline condition assessment findings prioritized by probability of failure and consequence of failure. Annual pipeline rehabilitation costs are estimated to increase to \$30 million per year during Phase 2.</p>	Continue to implement phased dry weather flow interceptor redundancy in incremental projects when cost effective relative to rehabilitation or level of service requirements. The proposed gravity flow connection on Concord Street from the DRI to the NIEA will provide substantial ability for GLWA to divert upstream flows from the DRI for future rehabilitation in the downtown area.
PHASE 3		<p>Reinspect leased trunk sewers and interceptor again between 2025 and 2030, then every 10 years, except higher risk sections more frequently</p> <p>Perform trunk sewer, interceptor and outfall rehabilitation based upon pipeline condition assessment findings prioritized by probability of failure and consequence of failure. Annual pipeline rehabilitation costs are estimated to increase to \$35 million per year during Phase 3.</p>	Downsize the Fairview PS after new Conner Sanitary PS routed to NIEA

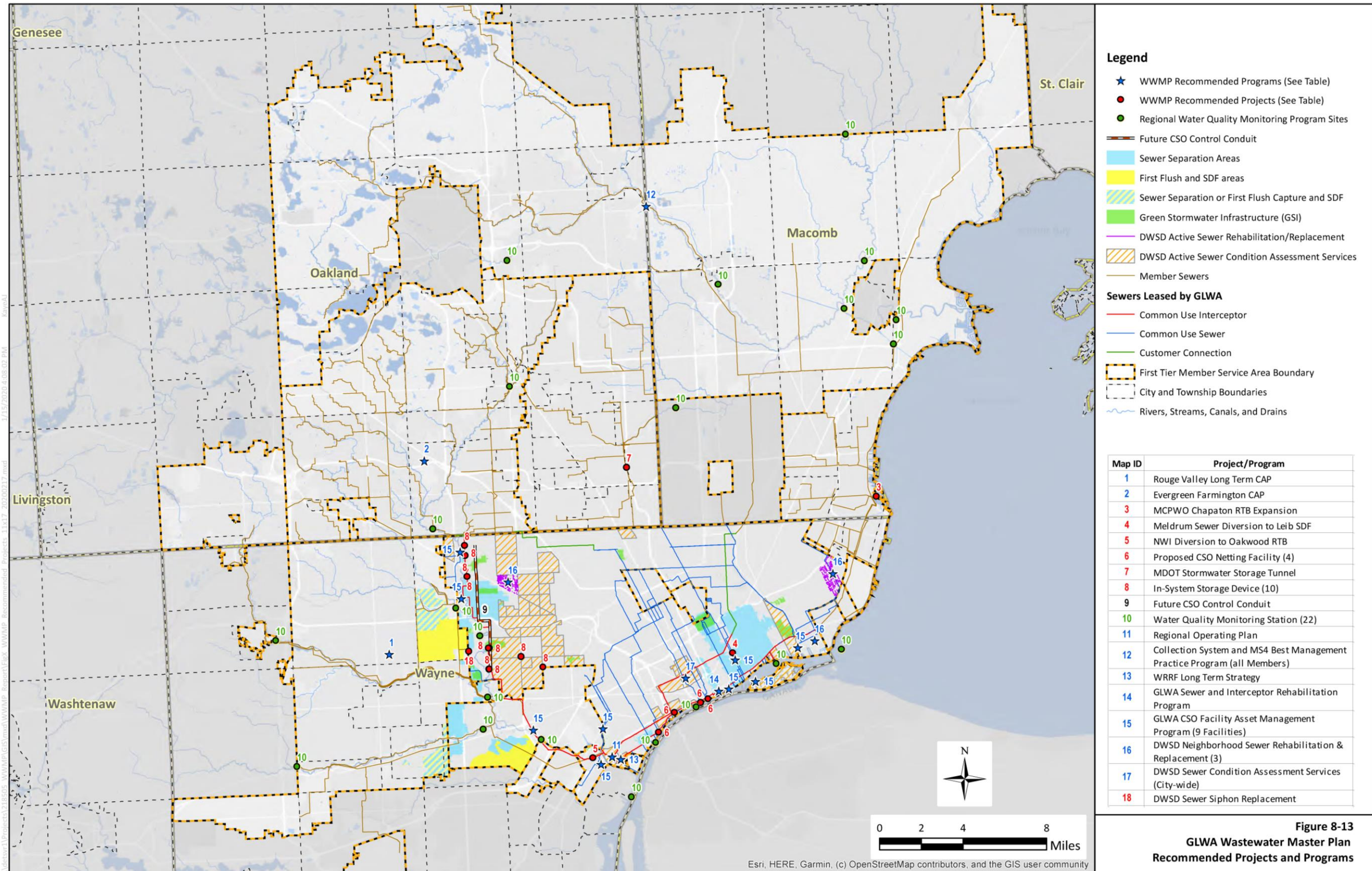

Figure 8-14. GLWA Wastewater Master Plan Recommended Projects and Programs

Figure 8-13
GLWA Wastewater Master Plan
Recommended Projects and Programs

Esri, HERE, Garmin, (c) OpenStreetMap contributors, and the GIS user community

Section 9

Implementation

9.1 Overview

This section outlines the general process for implementing the programs and capital improvement projects proposed in this Wastewater Master Plan. The development of the Wastewater Master Plan was a regionally collaborative effort of GLWA, its Members, SEMCOG, regional stakeholders, Michigan EGLE and Michigan DOT. This collaborative process affirmed that pipes and waterways don't know jurisdictional boundaries and that the region can accomplish more for less by applying a regionally integrated planning framework. Accordingly, implementation of the plan requires cooperative efforts by all parties. GLWA proposes to lead implementation with its new capital projects, operational improvements, and new programs. Through its role as the regional hub utility, GLWA will also facilitate collaboration with its Members, Michigan DOT and regional stakeholders.

The implementation process described in this section is designed to guide cost effective progress toward the 5 desired outcomes. This includes progressive improvement towards water quality standard attainment using a phased and adaptive approach targeting specific incremental water quality milestones. The phased and adaptive approach will be guided by a new program to continuously monitor dry and wet weather water quality for all receiving waters within the GLWA regional service area. Current data characterizing water quality conditions and improvements will support all NPDES permit holders and Michigan EGLE in prioritizing actions and schedules to achieve water quality goals for the region.

This section includes the following implementation tools and strategies:

- Phased and Adaptive Implementation Strategy
- Regionally Coordinated Regulatory Compliance Sequence
- Collection System and MS4 Best Practices
- Regional Operating Plan
- Regional Water Quality Monitoring Program
- Coordination with the Regional Transportation Plan and MDOT Highway Improvements
- Using GSI as an Adaptive Management Strategy
- 5-Year Assessments of Water Quality, System Performance, and Resiliency
- Annual Capital Improvement Planning
- External Funding
- Framework for Addressing Affordability

- Communication Plan
- Advanced Planning

9.2 Phased and Adaptive Implementation Strategy

Three major implementation phases of the Wastewater Master Plan have been identified based on progressive cost effective attainment of water quality goals within the receiving waters of the GLWA service area. The three phases are based on an adaptive framework that uses progress assessments and plan refinements to maximize the value of future investments. Projects and programs that can produce the most regional water quality benefit and other triple bottom line benefits for the least cost are planned for Phase 1. Phase 1 projects focus on maximizing the use of existing assets and controlling the amount of stormwater that enters combined sewers through green inflow reduction projects. Phase 2 and Phase 3 projects are identified as adaptive, in that they might be refined following assessment of the progress achieved and lessons learned realized through Phase 1. Figure 9-1 shows the steps along the phased implementation pathway. These projects are discussed in more detail in Section 8. Table 9-1 presents the three phases with specific water quality milestones and asset management priorities for existing infrastructure at the WRRF and within the regional collection system.

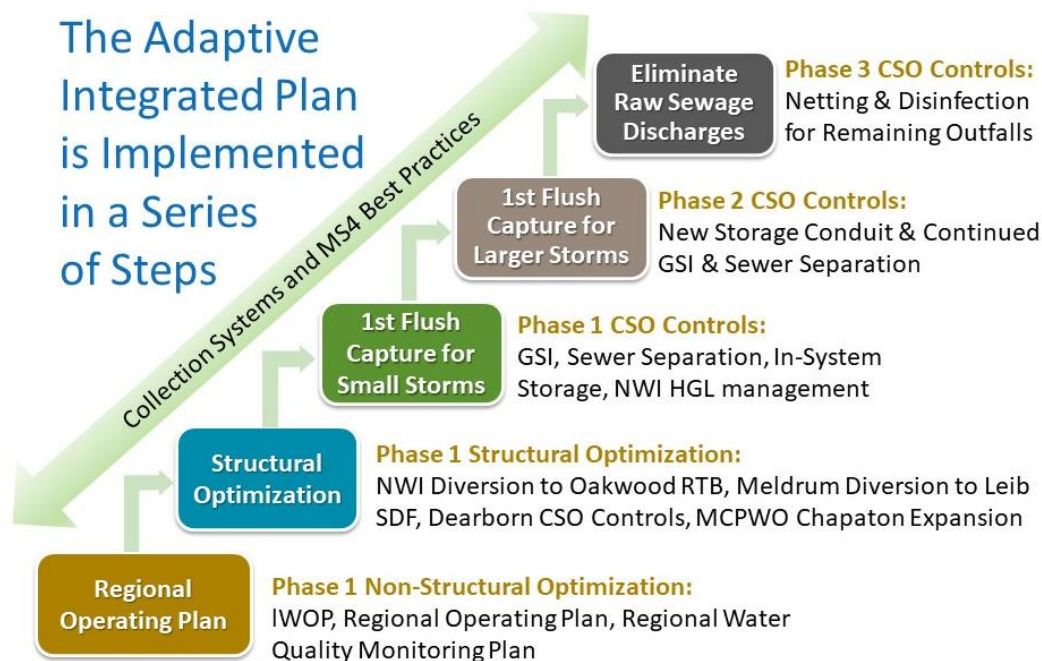

Figure 9-1. Steps Along the Phased and Adaptive Implementation Pathway

EGLE has suggested a potential fourth phase could be required to meet Categorical Standards. Categorical Standards establish requirements for secondary treatment of flow from separated sanitary sewer systems. GLWA's regional collection system includes a mix of separated sewer systems and combined sewer systems, and the North Interceptor East Arm was designed to convey many of the separated sewer systems to secondary treatment at the WRRF.

Approximately 94 percent of all dry and wet weather flow from the GLWA region received secondary treatment during the 7-month 2018 continuous simulation period used in this Wastewater Master Plan for evaluation of alternatives. Michigan EGLE currently evaluates compliance with secondary treatment requirements by monitoring the highest peak hour dry weather flow in April each year. Using that criteria, GLWA currently meets requirements for secondary treatment. (Additional information is provided in Section 5). Cumulative improvements in system optimization and new facilities are anticipated to increase the percentage of flow receiving secondary treatment by the end of Phase 3. GLWA plans to continue monitoring this and consider Phase 4 activities if necessary, in the future.

Table 9-1. Implementation Phases

Phase	Water Quality Goals	Collection System and WRRF Infrastructure Goals	Water Resource Recovery Goals
Phase 1 Optimize	Achieve Dry Weather DO and Partial Body Contact Standards Reduce Public Health Risks and Dissolved Oxygen drops below 5 mg/l by CSO capture of small storm (1-month return frequency events	Continue on-going condition assessment inspections and needs assessments for facilities. Perform improvements to existing assets to renew service life, improve performance for new needs. Optimize existing collection system facilities to use available capacity, expand real time control capabilities. Complete Committed Projects by GLWA Members.	Reduce energy consumption through identified energy saving measures. Reduce ferric chloride use through Enhance Biological Phosphorus Removal, improvements at chemical application points, and real time monitoring to control chemical dosing rates. Expand the use of screened final effluent to reduce potable water purchases for process water.
Phase 2 Adapt	Achieve Full Body Contact Standards during Dry Weather Achieve Aquatic Species Protection during wet weather	Adapt, upgrade or add new assets where a high return on investment can be achieved. Continue on-going condition assessment inspections and needs assessments for facilities.	Convert from chlorine gas to sodium hypochlorite or another disinfection process. Evaluate next generation biosolids options by 2035.
Phase 3 Sustain	Attain Full Water Quality Standards	Completion of proposed wet weather controls for remaining CSO outfalls that exceed NPDES criteria for extreme or limited discharge. Continue on-going condition assessment inspections and needs assessments for facilities.	Implement transformative projects for energy recovery from biosolids, phosphorus recovery, and reduction in volume of biosolids for disposal.

New capital projects, operational improvements and programs during each phase will be coordinated annually by GLWA and its Members through the GLWA Capital Improvement Program (CIP) process. The GLWA CIP process provides 5 and 10-year project forecast from which Members can plan their respective improvements. The development of the GLWA CIP coordinates between water and wastewater infrastructure improvements. It is recommended that GLWA and Members also coordinate projects in each phase with regional transportation projects, as discussed later in this section.

9.3 Regionally Coordinated Regulatory Compliance Sequence

Realizing the cost and prioritization efficiencies associated with regionally integrated planning requires a regionally integrated schedule that strategically sequences projects. Projects that produce the most regional benefit for the least cost are scheduled first. Adaptive projects that might be refined based on the effectiveness of earlier projects should be sequenced accordingly, so that lessons learned can be applied and cost optimization can be achieved through adaptive implementation practices. Figure 9-2 shows a preliminary sequence for the GLWA service area, including consideration of regional water quality projects and MDOT construction projects. MDOT's large highway projects include stormwater storage, green stormwater infrastructure, and sewer separation that are integral with CSO control projects within the service areas of the GWK Drainage District, DWSD, and GLWA. Figure 9-2 is intended to show the sequence and inter-relationship of projects and not actual start and completion dates. Dates for wet weather compliance projects in Phase 1 and Phase 2 will be developed during the GLWA Long Term CSO Control Plan.

Figure 9-2. Regional Compliance Schedule by Phase

	PLANNING			PHASE 1										PHASE 2						PHASE 3				
GLWA PROGRAMS																								
<i>Permitting, Planning, and Reporting</i>																								
<i>West Side Model</i>																								
<i>Wastewater Master Plan and Regional Operating Plan</i>																								
<i>LTCSO Control Plan</i>																								
<i>System Optimization and Water Quality Monitoring</i>																								
<i>IWOP Development and Approval</i>																								
<i>IWOP Control Rules Implementation</i>																								
<i>Regional Operating Plan Initial Period Goals</i>																								
<i>Regional Water Quality Monitoring and Regional Model Updates</i>																								
<i>Voluntary Reporting of Best Practices for MS4 and Collection Systems</i>																								
<i>Upper Rouge River High Priority Non-Core LTCSO Control Projects</i>																								
<i>Quick Wins -- Backwater Gates, SCADA Improvements</i>																								
<i>NWI Diversion to Oakwood RTB</i>																								
<i>Phase 1 In-System Storage on Trunk Sewers East Side of Rouge River</i>																								
<i>Phase 1 Sewer Separation in Priority Outfalls West Side of Rouge River</i>																								
<i>Near East Side Detroit River High Priority Non-Core LTCSO Control Projects</i>																								
<i>IWOP Detroit River Interceptor Regulator Improvements</i>																								
<i>Phase 1 Pilot Netting Facilities at B-020 and B-023</i>																								
Phase 1 Meldrum Sewer Diversion to Leib SDF																								
Phase 1 Fischer District Sewer Separation																								
<i>Remaining Non-Core Projects -- Rouge River</i>																								
Phase 2 Sewer Separation Projects																								
Phase 2 CSO Control Conduit																								
Phase 3 Netting and Disinfection																								
<i>Remaining Non-Core Projects -- Detroit River</i>																								
Phase 2 Sewer Separation Projects																								
Phase 3 Netting and Disinfection																								
<i>GLWA WRRF Improvements Presented Separately in Section 7</i>																								
<i>DWSD</i>																								
<i>DWSD Green Infrastructure</i>																								
<i>DWSD Condition Assessment and Sewer Rehabilitation Program</i>																								
<i>Dearborn</i>																								
Dearborn Sewer Separation Lower Rouge																								
Dearborn CSO 013/014 First Flush Capture and SDF Main Rouge																								
<i>Dearborn Heights</i>																								
Ashcroft Drain Consolidation to Dearborn Heights RTB or Separation																								
<i>Redford Township</i>																								
Bell Branch CSO Consolidation and RTB or Sewer Separation																								

	PLANNING			PHASE 1						PHASE 2						PHASE 3											
Ashcroft Drain CSO Consolidation and RTB																											
<i>Inkster</i>																											
Lower Rouge CSO Consolidation to Middlebelt RTB or Separation																											
RVSD Long Term Corrective Action Program																											
Asset Management Phase 1																											
EFSDS ACO Program																											
Corrective Action Plan																											
Construction																											
Project Performance Certification																											
MCPWO																											
Chapaton Expansion																											
Clinton Township Eliminate SSOs																											
Centerline Eliminate SSOs																											
STORMWATER MANAGEMENT PARTNERSHIP PROGRAMS																											
MDOT Projects																											
<i>I-75 and GWKDD RTB Expansion</i>																											
I-375 Improvements and Stormwater Separation																											
<i>GHIB Stormwater Separation</i>																											
I-94 Modernization Segment 3																											
I-94 Modernization Segment 2																											
I-94 Modernization Segment 1																											
<i>Projects in red italics are completed or committed; vertical grid lines illustrate relative sequencing not calendar years</i>																											
Updated: December 31, 2019																											

9.3.1 Implementation Pathways and GLWA Hub Utility Leadership

The Adaptive Integrated Plan developed by GLWA and its Members leverages the power of regional optimization and the flexibility of adaptive management to cost effectively achieve the shared desired outcomes at a pace that manages affordability. This is accomplished through an implementation strategy spanning multiple regionally integrated parallel paths with GLWA integrating and coordinating as the hub utility (see Figure 9-2). These implementation pathways will

IMPLEMENTATION PATHWAYS

- Member Committed Projects
- Asset Management
- System Optimization
- WRRF Improvements
- Long Term CSO Control Plan
- Green Infrastructure
- Sewer Separation
- Regionally Integrated Planning

GLWA Hub Will Integrate Regional Activities and Guide Adaptive Management



Figure 9-2. The Adaptive Integrated Plan Leverages GLWA Hub Utility Leadership and Regional Partnerships

proceed in parallel and complement one another based on cost optimized prioritization of activities that will be adaptively reviewed, updated, and informed by water quality monitoring and implementation progress. GLWA will update the regionally coordinated regulatory compliance sequence through continued coordination with Member and other regional partners such as MDOT throughout implementation. This coordination will be important to maximizing the cost optimization opportunities associated with the Adaptive Integrated Plan.

9.3.2 Coordination of Wayne County Rouge Valley Corrective Actions with CSO Control Programs for Redford Township, Dearborn Heights, and Inkster

There is a major inter-relationship between MDOT projects and future sewer separation projects proposed within the DWSD service area along the Detroit River. An inter-relationship also exists between the Wayne County Rouge Valley Long Term Corrective Action Program (Rouge Valley LTCAP) and the CSO control projects by the cities of Inkster and Dearborn Heights, and Redford Township. Phase 1 of the Rouge Valley LTCAP includes a pilot program to throttle combined sewer regulator connections from Inkster, Dearborn Heights and Redford.

The goal of the pilot program is to assess the effectiveness of reducing the flow contribution from the combined areas to the interceptors during significant wet weather events to allow preferential flow from separated sewer systems. The increase in CSO during peak wet weather flows is intended to be offset by providing more capacity for combined sewer flows during non-critical wet weather periods. This strategy requires new automated control structures and an advanced real time logic system.

Regulator modifications for CSO throttling as part of the Rouge Valley LTCAP consist of adding a control gate to the interceptor sewer connection on the downstream side of the CSO regulator structure. Under normal dry weather and most wet weather rain event conditions, the control gate would be left fully open, allowing the regulated flow discharge to the interceptor as designed.

During significant rain events, the control gates would be closed to bypass the regulated flow to the river with the CSO discharge, thereby reducing flow in the interceptor during the critical periods. An automated control system consisting of interceptor level sensors and flow meters would be used to identify critical system conditions for closing and re-opening the gates, with automated controls via the RVSDS SCADA system to close the gates only when necessary.

The pilot program for CSO regulator controls in the Phase 1 Rouge Valley LTCAP will begin in 2020. Planning and design for long term CSO controls by Inkster, Dearborn Heights and Redford Township will need to consider the impacts of these new CSO regulator controls.

9.4 Collection System and MS4 Best Practices Program

The Collection System and MS4 Best Practices Program is a proposed new initiative for GLWA and its Members. This new program is designed to leverage GLWA's "Hub Utility" role and its One Water Partnership to guide all Members (first and second tier) to apply best practices for wastewater collection system and separate storm water system inspection and maintenance.

This GLWA program is designed to complement the proposed new Contributing Municipality Collection System General Permit to be implemented by Michigan EGLE in 2020. The new General Permit applies to separated sanitary sewer systems that discharge to a wastewater treatment plant not owned by the municipality and have been determined by Michigan not to need an individual NPDES permit. The new General Permit establishes requirements for:

1. Proper Operation and Maintenance
2. Asset Management Program Requirements
3. Capacity and Management Requirements
4. Inspection Frequency
5. Fiscal Responsibility
6. Submittals and Reporting

Another related initiative in 2020 will be Michigan House Bill 4100 to enable the creation of stormwater utilities in the state. Enactment of this legislation would provide additional institutional and funding resources for GLWA Members which elect to form a stormwater utility to improve flood protection and stormwater quality.

The GLWA Collection System and MS4 Best Practices Program is proposed to be implemented starting in 2020 through a new collaborative workgroup of GLWA Members tentatively called the "Watershed Work Group". Initial activities of Collection System and MS4 Best Practices Program are proposed to include:

1. Annual voluntary reporting of inspections, maintenance, sewer cleaning, catch basin cleaning, infiltration/inflow studies, and rehabilitation.
2. Development of a pilot program to identify cost-effective improvements to regional practices that will improve dry weather water quality.

The proposed form and initial set of content questions for the annual voluntary reporting of collection system and MS4 best practices is presented in Section 8. The annual survey is intended to be an on-line form with a database so that previous year information that remains applicable does not need to be re-entered. The 5-year assessments of system performance discussed later in this section would include summary level progress on Member Collection System and MS4 Best Practices.

9.4.1 Pilot Study for Dry Weather Water Quality Improvement

Section 6 discusses the significance of pollutant loads from stormwater, dry weather discharges from blocked sewers, and contamination of stream flow from non-point sources entering the boundaries of the GLWA regional system. These dry weather sources of pollution need to be managed through source control, inspections, preventive maintenance, and compliance with development and redevelopment permits.

A three-phase program is proposed to manage dry weather pollution sources in the first two phases and manage separate stormwater quality in the third phase:

- Phase 1: Reduce pathogen concentrations to meet partial body contact standards in dry weather, and reduce organic materials to meet dry weather dissolved oxygen protection for aquatic species
- Phase 2: Further reduce pathogen concentrations to meet full body contact standards in dry weather, and maintain dry weather dissolved oxygen to protect aquatic species
- Phase 3: Maintain dry weather protections and meet water quality standards for separate stormwater discharges in wet weather

It is proposed that GLWA design a pilot study for Phase 1 as one of the initial activities of the new Watershed Work Group. This should be a collaborative program that engages representatives of Tier 1 and Tier 2 Members with responsibilities under the MS4 regulations and the new Contributing Municipality Collection System General Permit.

The pilot study should include research into similar dry weather source control and collection system maintenance programs in other areas. For example, along the Merrimack River in Massachusetts, a successful program was implemented among several communities focusing on six key areas:

1. Adequate Staffing
2. Preventive Maintenance
3. Infiltration/Inflow Control
4. Collection System Mapping
5. Collection System O&M Plan
6. Annual Reporting

9.5 Regional Operating Plan

The goal of the Regional Operating Plan is to improve the performance of the regional collection system through new tools for real time controls, regional pre-storm planning, post-storm event analysis, a regional storage dewatering plan, and the use of the Regional Wastewater Collection System Model in conjunction with SCADA data from the GLWA and Member operations.

Development of the Regional Operating Plan is described in the report “Optimization of Regional Operations”, which is a part of this Wastewater Master Plan. A separate report “Regional Operating Plan” provides the essential information regarding regional operations intended for reference in future NPDES permits for GLWA and its Members.

The Regional Operating Plan will be implemented in a pilot phase beginning in 2020 and extending to the end of 2022. Specific objectives are established for the first three years, and at the end of the pilot phase new objectives will be established for future years.

9.6 Regional Water Quality Monitoring Program

This Wastewater Master Plan provides water quality monitoring findings and proposes a regional plan for attaining Michigan’s water quality standards. The regional plan is designed to protect water quality during dry weather and wet weather and includes specific water quality attainment goals for each phase. An on-going Regional Water Quality Monitoring Program will provide the data necessary to adaptively align water quality protection project priorities for each phase with compliance priorities by watershed.

Progress towards attainment of water quality standard milestones will be measured using data gathered through the proposed Regional Water Quality Monitoring Program described in Section 8 and Technical Memorandum 6A. The GLWA System Control Center began implementation of the Regional Water Quality Monitoring Program in the fall of 2019. Initial planning-level contacts were made with USGS to develop a cooperative agreement to establish and operate the monitoring sites, and to establish data communications with GLWA. Implementation of the first phase of the program is anticipated to begin during 2020. Data collected through the year 2022 should be considered for use in conjunction with the preparation of the next GLWA NPDES permit renewal in 2023.

9.7 Collaboration with Regional Transportation Plan and MDOT Highway Improvements

9.7.1 Regional Transportation Plan

SEMOG is responsible for developing and implementing a long-range vision for transportation in the seven-county Southeast Michigan region. This vision is designed to maintain a transportation system that is safe, accessible, reliable and contributes to a high quality of life for the region’s citizens. The transportation infrastructure (roads, bridges, nonmotorized pathways, transit routes, and facilities) and the people and vehicles that use it impact the physical landscape. It is important to consider this interaction when planning, designing, constructing, and maintaining the transportation system. With that in mind, SEMCOG has developed a regional analysis of impacts of planned transportation projects on the environment and a series of guidelines for mitigating those impacts.

SEMCOG has defined and identified environmentally sensitive resources in the region and analyzed the likelihood of planned transportation projects impacting those resources. The goal is to balance transportation needs with environmental protection by constructing and maintaining a transportation system that minimizes negative impacts, and where possible, increases appropriate public access to environmental resources. Where impacts cannot be avoided, mitigation activities should be considered. To that end, SEMCOG promotes good planning practices via a series of guidelines for consideration by road and transit implementing agencies.

First, overall guidelines are presented that should be considered for all types of projects, regardless of the resource impacted. Then, guidelines specific to each type of resource are presented. The resource-specific guidelines present an introduction highlighting the importance of the resource and reasons the resource should be preserved; a summary of how the existence of the resource is identified and the types of activities that would be considered to have an impact; specific mitigation activities that should be considered during the planning and design phases as well as the construction and maintenance phases; and information sources for reference.

SEMCOG continues to develop data, technical tools, and planning techniques necessary to facilitate a better understanding of the interaction between transportation and the environment and the possible benefits and drawbacks of current and future transportation plans. SEMCOG prepares an annual forecast of the next 5-years of transportation projects in the region called the Transportation Improvement Program (TIP). There are numerous categories of projects by different layers and this covers the entire 7 county region for MDOT and all federal-aid projects through the counties and the cities, that have been approved through Federal Aid Committees and SEMCOG's Transportation Coordinating Council.

As part of the FHWA transportation planning requirements, SEMCOG must complete an Environmental Sensitivity Analysis for all projects submitted for the Regional Transportation Plan TIP. The Environmental Sensitivity Analysis is evolving to include project locations in relation to combined sewer areas. GLWA should continue discussion with SEMCOG in 2020 regarding more detailed procedures to integrating the TIP and criteria for the Environmental Sensitivity Analysis with the capital improvement programs of GLWA, DWSD and other GLWA Members.

9.7.2 Coordination with MDOT Projects in the Region

The Adaptive Integrated Plan relies on important partnerships with MDOT to manage stormwater entering the combined sewer system as they advance their own infrastructure improvement projects. Coordinated planning of projects will help maximize the value from these opportunities to cost effectively reduce sewer overflows as was demonstrated through the substantial coordination between MDOT, DWSD and EGLE achieved during the Wastewater Master Plan development process. A series of discussions and preliminary permitting procedures were completed for:

- Gordie Howe International Bridge
- I-375 Improvements
- I-94 Modernization Project
- M-39 Flood Control and Climate Resiliency Study

- I-75 Improvements

Table 9-2 presents a list of major coordination activities between the Wastewater Master Project and MDOT projects. This tabulation of activities includes work activities directly with the Wastewater Master Plan project. There were other meetings with DWSD, GLWA and EGLE regarding permit issues that are not included on this list.

An important element of coordination between GLWA and MDOT is sharing of the Regional Wastewater Collection System RWCS hydraulic and hydrologic model. All major MDOT project teams for the major highway projects are using the RWCS model and associated GIS data.

Table 9-2. Master Plan Coordination Activities with MDOT Projects

Date	Master Plan Coordination Activity
July 2017	Initiated communication with the MDOT GIS and Asset Management Group to obtain information on MDOT storm water drainage facilities for major state highways in the GLWA service area. Ultimately led to model representation of MDOT's connections to the GLWA regional collection system over several months.
October 2017	Coordinated with the West Side Model team in scheduling the meeting with MDOT to review the modeling of stormwater drainage from MDOT highways to the DWSD and GLWA collection systems.
November 2017	Prepared a summary graphic of the routing of MDOT highway drainage for review by MDOT and for scheduling a meeting with the Department in December.
December 2017	Held a meeting with MDOT to review the modeling of storm water drainage from MDOT highways to the DWSD and GLWA collection systems. Developed an approach for working with MDOT to resolve questions on MDOT's existing and proposed drainage facilities.
January 2018	Obtained additional drainage infrastructure data from MDOT based on the approach developed at the December 7, 2017 meeting with MDOT.
March 2018	Initiated coordination with SEMCOG and MDOT regarding a scope of services for evaluation of climate resiliency and flood control for highways based on a pilot area in Dearborn, Michigan.
August 2018	Communicated with the AECOM, SEMCOG and Bridging North America project teams regarding the release and sharing of hydraulic models of the regional collection system and collected metering data.
August 2018	Held a meeting with MDOT project managers on August 7, 2018, to collect information regarding stormwater management.
October 2018	Met with representatives of MDOT, AECOM, DWSD and MDEQ on October 30, 2018 to provide the current Regional Collection System Model to MDOT so that MDOT and its consultant can establish the hydrologic and hydraulic criteria for the surface storage basins at the Gordie Howe International Bridge point of entry facilities.
December 2018	Participated in a project start-up meeting on December 20, 2018, for the SEMCOG and MDOT Climate Resiliency and Flood Management Study. The Climate Resiliency task will provide planning criteria applicable to highway drainage for the SEMCOG planning area. The Flood Management task will focus on the M-39 corridor.
December 2018	Prepared for and attended a meeting with representatives of MDOT, DWSD and GLWA to discuss the I-375 Improvement Project on December 12, 2018. As a result of this meeting, there is a potential sewer separation project that could be performed in conjunction with the I-375 Improvements to eliminate CSO outfall B018.

Date	Master Plan Coordination Activity
January 2019	As a result of the meeting with MDOT and SEMCOG on December 20, 2018, GLWA and DWSD prepared a letter to MDOT seeking discussion of a policy to remove highway drainage from combined sewer systems in conjunction with major highway improvement projects.
January 2019	Prepared follow-up information for transmittal to MDOT for the I-375 Improvement Project. Made requests to GLWA and DWSD for GIS data showing easements, water, and sewer pipelines. Initiated capacity analysis for B-017 for stormwater only.
February 2019	Began discussions with the MDOT I-94 Improvement Project regarding their Drainage Plan on February 20, 2019.
February 2019	On February 13 and 25, 2019, communicated with Bridging North America, MDOT, GLWA and DWSD regarding their questions on the GHIB Point of Entry site drainage design and the model of the GLWA regional collection system provided on October 30, 2018.
April 2019	Participated in a meeting on April 9, 2019, related to the Gordie Howe International Bridge (GHIB) Project. This meeting included a review of the proposed drainage plan, DWSD permitting requirements, and use of the RWCS Model.
April 2019	Outfall capacity assessment for I-375
May 2019	Communications with Gordie Howe International Bridge (GHIB) Project. This meeting included a review of the proposed drainage plan, DWSD permitting requirements, and use of the RWCS Model.
June 2019	Reviewed the Hydrologic Design Report Gordie Howe International Bridge (GHIB) Project and provided comments on June 24, 2019.
July 2019	Meeting on I-375 Improvement Project regarding alternatives for roadway alignments, existing sewers, and sewer separation
August 2019	Technical discussions, drawings, GIS data, outfall capacities
October 2019	Conference call with representatives of GLWA, SEMCOG, MDOT and Tetra Tech on October 22, 2019, to discuss findings of the M-39 Flood Mitigation Study. CDM Smith will provide hourly rainfall data for the August 11, 2014 storm event to Tetra Tech as an action item from this conference call.
October 2019	Reviewed the Supplemental Draft EIS for the MDOT I-94 Modernization Project and prepared comments on behalf of GLWA on October 18, 2019.
October 2019	Prepared for and attended a conference call with representatives of GLWA, SEMCOG, MDOT and Tetra Tech on October 22, 2019, to discuss findings of the M-39 Flood Mitigation Study. CDM Smith will provide hourly rainfall data for the August 11, 2014 storm event to Tetra Tech as an action item from this conference call.
December 2019	GHIB conference call on December 12 – questions of how to use the RWCS model, boundary conditions, and simulation and design criteria for stormwater discharges to CSO outfalls downstream of the DRI
December 2019	M-39 meeting on December 11 regarding coordination of M-39 highway and drainage improvements with GLWA NWI to Oakwood RTB diversion and the sealing of manhole in the underpass at Hubbard Drive
December 2019	I-94 meeting on December 18 – MDOT presented the results of the I-94 Drainage Study

Regular meetings between MDOT, DWSD and GLWA should continue as the highway projects move into design and construction phases, or as new projects are identified during implementation of the Adaptive Integrated Plan. Building upon these cooperative partnerships should generate more cost optimization opportunities over the 40-year planning period of the wastewater master plan that

should be leveraged to progressively manage the cost of CSO control and achievement of water quality standards.

9.8 Using GSI as an Adaptive Management Strategy

Green stormwater infrastructure (GSI) is being implemented by GLWA Members as a CSO control measure, and by property owners, developers, and Michigan DOT in a variety of projects throughout the GLWA service area. Construction of GSI features in new developments, municipal capital improvement projects, and highway projects is driven by compliance with stormwater ordinances and by public interest in sustainability and more attractive public landscapes. Another driver of GSI implementation is improved resiliency for potential climate change. This section discusses strategies to optimize the beneficial impacts of GSI to reduce the scale of future grey infrastructure.

9.8.1 Measurement of Effectiveness

Several approaches can be considered to measure the effectiveness of GSI that is implemented. These approaches are listed below in order of increasing complexity. These are not mutually exclusive measures.

- **Geographic Metrics.** Estimated reductions in directly connected impervious area have been shown in the scientific literature to be strongly correlated to many water quality and aquatic ecosystem impacts. Impervious cover may be considered “non-directly connected” if it is removed, diverted to a pervious area of sufficient size and infiltration capacity, or diverted to GSI. Other relatively simple geographic metrics may include the total surface footprint or vegetated footprint of GSI systems in a particular area, and the total area of tree canopy over impervious surfaces. Many co-benefits are related to these metrics.
- **Measured/Estimated Water Budget Component Trends.** Estimates of the amount of rainfall that is apportioned into infiltration, evapotranspiration, untreated runoff, and detained/treated runoff is another useful effectiveness measure. Water budget components can be estimated at the site scale using monitoring data and at the watershed/sewer system scale using calibrated models. Results can be compared to design and performance criteria.
- **Estimated Pollutant Load Reductions.** Pollutant load reductions can be estimated based on water budget components using the academic/professional literature on pollutant concentrations in treated and untreated stormwater. Pollutants of interest may be driven by regulatory requirements such as CSO and MS4 regulations/permits and TMDLs. Estimated loads of sediment, trash, and debris removed from stormwater may also be of interest in urban areas for both water quality and community objectives. Direct measurements of pollutant concentrations at the local scale tend to be highly variable and may be best thought of as a longer-term research activity to contribute to existing national literature.
- **Measured/Estimated Reductions in Peak Runoff Rate.** This can be directly measured at the site scale and/or estimated at the watershed/sewer system scale using calibrated models. Results can be compared to design and performance criteria.

- **Public Opinion Surveys and Estimates of Co-benefits.** Some co-benefits can be measured directly (e.g., urban temperature and air quality) while others can be estimated (e.g., physical and mental health improvement due to greenery). Some communities and utilities have chosen to study co-benefits in a formal benefit-cost framework, while others have chosen to simply track a range of metrics without expressing them in monetary terms. Depending on local goals and objectives articulated through the planning process, formal measurement of community perceptions and responses to GSI may be performed by planners or social scientists.
- **Measurements and Estimates of Stream Channel Erosion.** Measurements and estimates of stream channel erosion and deposition in response to GSI implementation are challenging but may be desirable to address regulatory requirements or goals set by stakeholders.

Any of the metrics discussed above may be combined with estimated or actual cost data to create cost-effectiveness metrics. Estimates of capital (design and construction), annual maintenance, and life cycle cost (design, construction, and maintenance over the life of the project) may be incorporated.

9.8.2 Target Areas for GSI Implementation

Target areas for implementation of GSI include areas of new development, primarily outside Detroit, and areas of projected redevelopment, primarily inside Detroit. In areas of new development, stormwater ordinances are a primary strategy being employed to realize water quality, channel protection, and peak flow control benefits. In areas of redevelopment, strategies include DWSD's 2018 stormwater requirements for private property; fees, credits, and incentives to encourage voluntary implementation on private property; targeted investment in the drainage area originally identified for the Upper Rouge Tunnel, and a potential to focus investment in other areas with a concentration of vacant and abandoned property projected to undergo redevelopment.

9.8.3 Strategies for Vacant Lots

Studies of vacant land in the City of Detroit indicate up to 40 square miles of vacant land out of a total area of 143 square miles (Gallagher, 2010), comprising approximately 150,000 properties, with about one-third currently containing buildings (Detroit Future City, 2012).

The Detroit Water and Sewer Department NPDES permit (MDEQ, 2019) and GSI plan (DWSD, 2014) describe a strategy for vacant lots. In summary, the plan is to remove impervious cover and leave soil conditions that will tend to minimize surface runoff. This approach meets multiple environmental objectives, including reducing or preventing increases in runoff volume, pollutant loads, and peak runoff that may contribute to urban flooding. Sites may be suitable for interim or permanent land uses such as community gardens and are left in a condition suitable for future development under the terms of the city's stormwater ordinance and other applicable codes. There is also a potential to target public infrastructure investments, such as street repaving and sewer separation, in these areas to facilitate both environmental and economic revitalization goals. The NPDES permit (MDEQ, 2019) describes these requirements:

Provisions for demolition and removal of vacant structures and replacement with pervious land cover. Where demolition is planned and implemented at sites that will be

re-purposed for GSI, the demolition specifications shall ensure that basements and other impervious surfaces at the sites are removed, that the site is raked to remove large rocks and construction debris, and that engineered soils consisting of an appropriate mix of topsoil, compost, and sand is applied following the demolition to support plant growth and promote infiltration...

For the near-east side of the City, there has been another GSI program in the tributary area to Detroit River Outfalls 005 - 009, 011, and 012. Because of the potential for some larger-scale green projects due to a relatively large amount of vacant land in the area, it may be possible to eliminate or reduce the size of some previously envisioned CSO treatment facilities for this area using the combination of GSI implementation along with possible sewer separation, and other engineering solutions. With GSI implementation now spreading across the city, it is acceptable for the city to use one-third (1/3) of the total GSI expenditures on projects upstream of untreated CSOs other than Rouge River Outfalls 059-069, 072-075, 077, and 079.

GLWA should evaluate the measures of GSI effectiveness discussed above, select one or more of these measures to include in the 5-year assessments discussed later in this section. Tracking GSI progress at 5-year intervals will provide a basis for improving the Regional Wastewater Collection System Model to better predict GSI benefits in stormwater runoff reduction.

9.9 Five-Year Adaptive Management Assessments of Water Quality, System Performance and Resiliency

Periodic reviews and revisions are a fundamental component of the Adaptive Integrated Plan implementation framework. This approach provides the flexibility needed to manage uncertainties and leverage cost optimization opportunities. Adaptive management assessments should include reviews and updates to planning tools, data, and assumptions as unknowns become known and decision support systems are advanced over the implementation time frame. In particular, as projects are implemented and new cost and performance data become available, assessments should be made to characterize system performance, water quality progress, and the cost efficiency of implemented technologies. The key findings from these assessments should then be applied to refine and potentially re-prioritize next steps.

The Regional Water Quality Monitoring Program is an important tool in the assessment and refinement process, as water quality is a direct measure for multiple desired outcomes. After several years of data are collected from the Regional Water Quality Monitoring Program, then cumulative assessments are proposed on 5-year intervals aligned with NPDES permit renewals. (Quarterly and annual publication of water quality data is also proposed, as discussed in Section 8.) The 5-year cumulative assessments should present trends for each water quality monitoring station, trends for each river, and trends for major public swimming and recreational areas. These cumulative assessments should address the performance measures for water quality discussed in Section 2 for the Five Outcomes of the Wastewater Master Plan.

The Five Outcomes for the Wastewater Master Plan also include regional system performance metrics for attainment of critical hydraulic grade line elevations, percent capture of wet weather flow, and annual volumes of flow provided primary and secondary treatment at the WRRF. Annual

reporting from the Regional Operating Plan should be used for the 5-year cumulative assessments of these system performance metrics.

The 5-year interval should also be used to monitor system resiliency measures related to the annual cycles of Great Lakes elevations and trends in rainfall, intensity and duration. Section 5 on Planning Criteria provides information on Great Lakes water level cycles and on mid-century and end of century climate models. Other regional, state and federal agencies, as well as universities will also be monitoring resiliency trends, and collaborative assessments are recommended.

The Climate Resiliency Study underway by SEMCOG and MDOT analyzes rainfall trends for southeast Michigan. This study considered using global climate models, and in consultation with the University of Michigan and University of Wisconsin, they analyzed a suite of six regional climate models. The regional climate models consider greenhouse gas emissions, air temperature and precipitation intensity and this study provides a baseline for future periodic assessments of rainfall duration and intensity trends. Great Lakes levels are correlated to the balance between regional precipitation and evaporation. 5-year assessment of trends should consider:

- Projected precipitation and air temperature using one or more of the regional climate models identified in the SEMCOG and MDOT Climate Resiliency Study.
- For the critical summer season, examine the historical record to identify periods of time when precipitation and air temperature were within this range.
- Identify a range of water surface elevations at relevant points of interest for planning applications (e.g., points on Lake St. Clair and/or the Detroit River) that occurred under these precipitation and temperature conditions. A range is expected because lake levels respond to a variety of hydrologic and hydraulic factors in addition to precipitation and evaporation.
- Assess the results relative to the peak elevation of El 577 NAVD88 (El. 99 Detroit Datum) on Lake St. Clair at Windmill Point, Detroit, for this Wastewater Master Plan, a representative water surface elevation to be used as a boundary condition.

9.10 Annual Capital Improvement Planning

GLWA's capital improvement planning process provides an annual opportunity for setting priorities for each upcoming fiscal year and for aligning 5-year and 10-year capital improvement and financial forecasts. The annual capital planning process can also be a time to consider changes to ownership of regional facilities and concurrent implementation of smaller projects and operational Quick Wins. This process is an important element of the proposed adaptive implementation framework.

9.10.1 FY2021 Capital Improvement Program

In August 2019, members of the Wastewater Master Plan project team worked with GLWA managers to prepare Business Case Evaluations and cost estimates for proposed capital improvement projects for FY2021. Recommendations from the Wastewater Master Plan that had been reviewed by GLWA and scheduled for the years 2021 to 2030 were considered by GLWA for inclusion in the FY2021 Capital Improvement Program (CIP). As a result, the major

recommendations for the early years of the planning period became a part of the next CIP to be reviewed and approved by GLWA and its Members in the spring of 2020.

9.10.2 DWSD Annual CIP

The Detroit Water and Sewer Department is engaged in a 5-year \$500 million condition assessment and capital improvement program for its wastewater collection and water distribution systems. Since the program launched in 2018, DWSD has repaired or replaced 22 miles of sewers. As part of a new neighborhood approach launched in summer 2019, DWSD began assessing the water and sewer systems by neighborhood. DWSD has also improved coordination of construction of capital improvements with DTE (natural gas and electric), telecommunication companies, and road agencies on a block-by-block basis.

DWSD and GLWA proactively coordinate projects in their respective operating programs and capital improvement programs. With the identification of proposed sewer separation projects, and the role of MDOT in those projects, planning between DWSD, GLWA and MDOT should be based on five-year and ten-year time horizons.

9.10.3 Wayne County Rouge Valley System Pipelines

As part of the work on the Regional Operating Plan, the inter-relationship of segments of the Wayne County conveyance system and the GLWA regional system was discussed. In two locations, GLWA has Member service connections upstream of conveyance conduits under the operational responsibility and ownership of Wayne County. These include an approximately 500-foot long segment of the Northwest Interceptor near Ford Road and the Fox Creek Enclosure in the Grosse Pointe communities. The Northwest Interceptor segment was recently inspected by GLWA as part of its pipeline condition assessment program. The Fox Creek Enclosure should be inspected by GLWA and a condition assessment performed.

Table 9-3 shows characteristics of the two conduits proposed for transfer to GLWA.

Table 9-3. Wayne County Wastewater Conduits Proposed for Transfer to GLWA

Conduit	From	To	Length	Size	Material	Original Construction Date	Source of Data
Northwest Interceptor	Near Evergreen Road	Near Southfield Road	~5,280 feet	7'-9"	Concrete	1955	GLWA GIS
Fox Creek Enclosure	Kerby Road PS	Ashland Sewer	~8,680 feet (Kirby Rd to Cadieux Rd) ~3,810 feet (Cadieux Rd to Bedford Rd) ~4,600 feet (Bedford Rd to Ashland St)	11'-6" H x 16'-6" W Arch (Kirby Rd to Cadieux Rd) 14'-0" Circular (Cadieux Rd to Bedford Rd) 15'-0" Circular (Bedford Rd to Ashland St)	Arch is Unknown (though likely brick) Design drawing show sewer thickness for the 14'-0" as 4 RB or 16" concrete and for the 15'-0" sewer as 5 RB or 20" concrete. (RB = ring brick)	Likely Constructed in early 1930s? Design drawing from Arch Sewer ~1929 14'-0" and 15'-0" Cylinder ~1927	RWCS Model Pipe location in RWCS model was based on design drawing from late 1920s

9.10.4 Quick Wins

Technical Memorandum 2 describes efforts by GLWA, the Wastewater Master Plan project team, and other project teams to identify smaller construction projects and operational changes that could be accomplished in parallel with the development of the Master Plan. These projects and operational changes were called "Quick Wins", and they included regulator cleaning, backwater gate improvements, elimination of river inflow at several locations, feasibility analysis for a new backwater gate at B-063 and fast-tracking certain analyses during the Master Plan to provide input to other concurrent projects.

The Quick Wins process proved useful as a means to collaborate across GLWA and DWSD operating units, as well as to engage the professional services teams to perform specific projects. It is recommended that GLWA continue to use the Quick Wins process periodically to complete smaller projects that could be holding up larger more critical goals. The essential parts of the Quick Wins process were:

1. Initial brainstorming of ideas with operating groups and consulting teams.
2. Prioritization of projects, and development of implementation steps for each project.
3. Appointment of a coordinator to send reminders and assist with communications.

4. Monthly review meetings to review progress and set the schedule for remaining work.

9.11 External Funding

GLWA will need to continue to expand efforts to secure external funding for its infrastructure improvement requirements. GLWA and its Members regularly rely on the Michigan State Revolving Loan Fund.

The Water Infrastructure Finance and Innovation Act of 2014 (WIFIA) established the WIFIA program to accelerate investment in the nation's water and wastewater infrastructure. The program is administered by the Environmental Protection Agency and works separately from, but in coordination with the State Revolving Fund (SRF) program to provide subsidized financing for large dollar-value projects. Projects that are eligible for Clean Water SRF are eligible for WIFIA funding, including enhanced energy efficiency projects at wastewater facilities, and acquisition of property if it is integral to the project or will mitigate the environmental impact of a project. Planning, preliminary engineering, design, environmental review revenue forecasting and other pre-construction activities are eligible as well as construction and reconstruction activities. Projects must be a minimum of \$20 million in size for large communities. Forty-nine percent of the project can be WIFIA funded, and total Federal assistance may not exceed 80%. Repayment may be deferred up to 5 years after substantial completion of the project and the loans mature 35 years after substantial completion. NEPA, Davis-Bacon, American Iron and Steel and other federal provisions apply.

The benefits of the WIFIA program is a single fixed rate is established at the loan closing and the borrower may receive multiple disbursements over several years at the same rate. The interest rate is based on the U.S. Treasury rate on the date of loan closing, and the rate is not impacted by the borrower's credit rating, although the borrower must be credit worthy and have a dedicated revenue source. The borrower can benefit from customized repayment schedules, providing flexibility to phase in rate increases over time.

The application process consists generally of 3 phases.

- **Phase 1: Project Selection** – Generally in the first quarter of the year EPA announces the amount of funding it will have available for the program and solicits letters of interest (LOI) from prospective borrowers. There is no cost to submit a LOI. The LOI includes information regarding the project's eligibility, the borrower's credit worthiness, and the projects feasibility and alignment with EPA's priorities. Based on this information EPA selects projects which it intends to fund.
- **Phase 2: Project Approval:** An application for WIFIA credit assistance is submitted by the borrower in this phase, and the WIFIA program conducts a detailed financial and engineering review of the project. Terms and conditions of the loan are proposed based on the review and negotiated with the borrower, and a project term sheet is executed.
- **Phase 3: Negotiation and Closing:** Based on the term sheet, the Administrator and the prospective borrower execute a credit agreement which is the legal document ensuring WIFIA funds.

9.12 Framework for Addressing Affordability

This Wastewater Master Plan proposes a diverse array of wastewater infrastructure investments for the WRRF, regional collection system, and CSO control facilities across the GLWA service area for a 40-year planning horizon. GLWA and its Members clearly understand that one of the most challenging elements of long-term planning is the allocation of scarce financial resources amongst competing needs and keeping improvements affordable to all ratepayers. Working with the Regional Collaboration Group, GLWA utilized a cost optimization decision support system to evaluate alternative control strategies for achieving desired outcomes.

The decision support system includes an integrated suite of watershed, collection system, and receiving water quality models which together allow for regionally integrated planning focused on maximizing regional water quality benefits, while containing the financial burden on ratepayers. Cost optimization includes leveraging synergistic regional collaboration opportunities; such as a GLWA and Member coordinated Regional Operating Plan, coordination of sewer separation and green stormwater infrastructure projects with MDOT, coordinated best practices for sewer system inspection and repair, and a Regional Water Quality Monitoring Program. The Adaptive Integrated Plan addresses affordability using a combination of strategies which together manage the financial burden on ratepayers. These include:

- Plan for the necessary costs associated with WRRF and collection system rehabilitation and asset management programs that maintain reliable high-quality service and prioritize accordingly
- Apply regional integrated planning principles using cost optimization decision support systems to identify and prioritize projects that maximize desired outcomes for the lowest regional cost
- Build and leverage synergistic opportunistic partnerships that reduce cost through collaboration, economy of scale, and shared objectives
- Select projects that produce additional community benefits that promote economic prosperity and elevate quality of life
- Phase in full compliance consistent with the NPDES permit through development of the Long Term CSO Control Plan updates due to EGLE in 2022
 - Schedule lower cost CSO control projects and asset management investments for early in the planning period (2023-2027 per NPDES 15.f.2)
 - Schedule the highest cost projects for CSO control later in the planning period
 - Continue utilizing and advancing the decision support system to support design and construction of Phase 1 projects and thereafter to assess progress and refine adaptive phase 2 and 3 project technologies, configurations, sizing, and implementation timing
 - Conduct financial capability evaluations with each permit renewal cycle and work with EGLE to develop adaptive implementation commitments, if necessary

9.13 Communication Plan

Representatives of the Regional Collaboration Group prepared a plan for communicating the Wastewater Master Plan to GLWA Members, local elected officials, environmental groups, the general public, and the media. The Communication Plan provides key messages and tools for each audience relative to the goals and progress of the Wastewater Master Plan. GLWA is implementing the Communication Plan in 2020.

Table 9-4. Key Audiences, Messages and Tools for the Communication Plan

Audience	Key Messages	Tools
GLWA Members	<ul style="list-style-type: none"> ▪ One Water is one system: regional and local. ▪ Recognizing it is one system enables us to optimize costs and rates. ▪ You can be champions in the community for accepting more systematic decision-making. ▪ To reap the benefits of a one system approach requires active member engagement in regional operations and modeling. ▪ Your customers can play a pivotal role in saving money and providing high quality service. 	<ul style="list-style-type: none"> ▪ Outreach Portal ▪ One Water Information Booth ▪ GLWA and Member Websites ▪ Public Service Announcements ▪ Annual Conference
Local Elected Officials	<ul style="list-style-type: none"> ▪ Regional collaboration is the key to cost optimization for your constituents. ▪ Regional collaboration is not lost independence, it is gained value. ▪ You have numerous opportunities to be the champion of success. ▪ Sustaining your revenue base (tax and utility) hinges on quality service. 	<ul style="list-style-type: none"> ▪ Elected Officials Ambassador Program ▪ Annual Briefing ▪ Public Presentation Series ▪ Elected Officials Data Base ▪ 90-Day Contact Calendar ▪ Print and Video Resources
Environmental Groups	<ul style="list-style-type: none"> ▪ You can help by embracing the plan without sacrificing ability to be critical. ▪ Your ongoing participation is welcome. ▪ You can be champions of public vigilance by multiplying personal actions supporting sustainable behaviors. ▪ Target criticisms to the correct audience. 	<ul style="list-style-type: none"> ▪ Green Summit ▪ New Environmental Page on GLWA Website ▪ 10 Ways GLWA Helps List ▪ 10 Ways Environmental Groups Can Help List ▪ Annual Environmental Award
General Public	<ul style="list-style-type: none"> ▪ Our success supports your quality of life in many ways ▪ You are key to that success ▪ Support needed investment ▪ Your personal actions matter 	<ul style="list-style-type: none"> ▪ Billing improvements ▪ Videos ▪ Public Service Announcement ▪ Short Documentary ▪ GLWA Environmental Education Partnership Kit ▪ Story Map Website/Mobile Device Application

Audience	Key Messages	Tools
		<ul style="list-style-type: none"> ▪ Social Media ▪ Retail Billing Mailing Inserts ▪ Branding Extensions
The Media	<ul style="list-style-type: none"> ▪ We respect your vital role. ▪ We have ongoing substance of interest to your audience. ▪ You can help us be better communicators 	<ul style="list-style-type: none"> ▪ Adapt Outreach Materials for Use with the Media ▪ Annual Media Seminar ▪ Create Narrative for Local Interest Stories

9.14 Advanced Planning

Three major advanced planning efforts are anticipated to follow this Wastewater Master Plan. Each of these efforts are anticipated to begin with the conceptual solutions proposed in this Master Plan and provide additional engineering, site selection, modeling and financial analysis to develop basis of design documents that can proceed to design and construction projects.

9.14.1 Long Term CSO Control Plan

An updated Long Term CSO Control Plan (LTCP) is a requirement of the GLWA NPDES Permit issued in July 2019. The LTCP must be prepared by November 15, 2022 and must address designated priority uncontrolled CSO outfalls on the Detroit River and the Rouge River. GLWA anticipates starting the LTCP in 2020. The Long Term CSO Control Plan will advance the components of the Adaptive Integrated Plan designed to meet water quality standards along the Rouge and Detroit Rivers and include a proposed compliance schedule in coordination with EGLE.

9.14.2 2021 SRF Project Plan

The GLWA NPDES Permit requires that a needs assessment for WRRF and regional collection system facilities be updated every five years as part of the SRF Project Plan. The next SRF Project Plan is due on October 1, 2021 including condition assessment and evaluation of service level.

9.14.3 2028 Biosolids Plan

Section 7 and Technical Memorandum 5B discuss near term and long term biosolids alternatives and proposed improvements. Major upgrades are anticipated for the multiple hearth incinerators by 2035, and the current contract operations agreement with NEFCO for the Biosolids Dryer Facility will terminate in 2036. Long term solutions evaluated in Technical Memorandum 5B should be re-evaluated in 2028 based on anticipated costs for energy and new developments in regulations for air quality and land application of biosolids.

Section 10

Glossary, Acronyms and Definitions

The following acronyms and definitions pertain to terms frequently used in the Wastewater Master Plan report and associated technical memoranda and reports.

BCE: Business Case Evaluation

BDF: Biosolids Dryer Facility

BFP: Belt Filter Press

BGD: Billion Gallons per Day

BOD: Biological Oxygen Demand as an identified pollutant present in sanitary sewage.

BPWG: Best Practices Work Group

CCR: Consumer Confidence Rule

CCTV: Closed-Circuit Television

cfs: cubic feet per second

CIP: Capital Improvement Plan

CMG: GLWA Capital Management Group

CMOM: Capacity, Management, Operation, and Maintenance

COF: Central Offload Facility

Collection System: Linear assets and facilities used to convey sewage and combined sewage to the GLWA WRRF or GLWA Customer Connection.

CSF: Central Services Facility

CSO: Combined Sewer Overflow

CWA: Clean Water Act

DDOT: Detroit Department of Transportation

DI: Ductile Iron

DNR: Department of Natural resources

DRI: Detroit River Interceptor

DRO: Detroit River Outfall

dtpd: Dry tons per day; typically used in reference to quantities of wastewater biosolids.

DWRF: Drinking Water Revolving Fund

DWSD: Detroit Water and Sewerage Department

EGLE: Michigan Department of the Environment, Great Lakes and Energy (formerly MDEQ)

EPA: United States Environmental Protection Agency

ERP: Emergency Response Plan

FMLA: Family Medical Leave Act

GDRSS: Greater Detroit Regional Sewer System. This naming convention has been used through the years to identify the GLWA and/or regional wastewater system including its pipes, manholes, facilities, and the like. It does not refer to collection pipes, structures and facilities other than those operated by GLWA.

GIS: Geographic Information System

GLWA: Great Lakes Water Authority

GPS: Global Positioning System

HGL: Hydraulic Grade Line

HVAC: Heating, Ventilation, and Air Conditioning

I&C: Instrumentation & Controls

ILP: Intermediate Lift Pumps

ISD: In System Storage Device

IT: Information Technology

ITS: Information Technology and Services

IWC: Industrial Waste Control

IWOP: Interim Wet Weather Operating Plan

LARE: Lake and River Enhancement

LCR: Lead and Copper Rule

Leased Assets: That portion of the Wastewater Collection System leased by the GLWA.

LED: Light-Emitting Diode

LEL: Lower Explosive Limit

LIMS/PIMS: Laboratory Information Management System/Project Information Management System

Linear Assets: Gravity sewer mains, pressure sewer pipes, manholes, air release valves, diversion structures, in-system storage devices, and the like that collect, transport and direct wastewater and combined sewage to specific facilities or Outfalls.

LWD: Large Woody Debris

MACP: Manhole Assessment Certification Program

MCC: Motor Control Centers

MDEQ: Michigan Department of Environmental Quality (former name of **EGLE**)

MDNR: Michigan Department of Natural Resources

MDOT: Michigan Department of Transportation

Member Outreach Portal: GLWA's repository of documents and data emerging from the Customer Outreach Program (<http://www.glwater.org/customer-outreachportal/>)

Member Outreach Program: GLWA's partnership with its wholesale customers to gather input on a variety of topics from development of charges, implementation of best practices, address operational issues and the development of the capital improvement program that consists of a family of work groups and committees.

mgd: Million Gallons per Day

MHI: Median household income

MMSD: Milwaukee Metropolitan Sewerage District

MS4 Permit: Municipal Separated Storm Sewer Permit

NAB: New Administration Building at the WRRF

NASSCO: National Association of Sewer Service Companies

NEC: National Electric Code

NEFCO: New England Fertilizer Company

NEORS: Northeast Ohio Regional Sewer District

NESDS: Northeast Sewerage Disposal System (former name for Wayne County portion of the **SEMSD** service area)

NIEA: North Interceptor East Arm

NPDES: US EPA National Pollutant Discharge Elimination

NPDES Permit: National Pollutant Discharge Elimination System Permit

NPL: US EPA National Priorities List

NWI: Northwest Interceptor

O&M: Operations & Maintenance

OEM: Original Equipment Manufacturer

O-NWI: Oakwood-Northwest Interceptor

OSHA: Occupational Safety and Health Administration

Outfall: Structure or pipe from which sewage, combined sewage or Storm Water exits a conveyance system and enters a waterway.

OWI: Oakwood Interceptor

PAC: Powdered Activated Carbon

PACP: Pipeline Assessment Certification Program

PAS: Planning Assistance to States

PCCP: Pre-Stressed Concrete Cylinder Pipe

PEAS: Primary Effluent to Activated Sludge

PLC: Programmable Logic Controller

PLD: Programmable Logic Device

PRV: Pressure Reducing Valve

PS: Pump Station

RAS: Return Activated Sludge

ROP: Regional Operating Plan

RTB: Retention Treatment Basin

RTC: Real Time Control

RVSDS: Rouge Valley Sewerage Disposal System

RWCS: Regional Wastewater Collection System

SAMO: System Analytics and Meter Operations

SCADA: Supervisory Control And Data Acquisition (GLWA uses Ovation brand)

SCC: Systems Control Center

SCP: Small Capital Projects

SCUBA: Self-Contained Universal Bi-directional Actuator

SDF: Screening and Disinfection Facility

SDWA: Safe Drinking Water Act

SEMCOG: Southeast Michigan Council of Governments

SEMSD: Southeast Macomb Sanitary District

Sewer SHARES: Percentage of annual Sewage Fund costs calculated for each GLWA Member.

SFE: Secondary Final Effluent

SFP: Sludge Feed Pump

SOW: Scope of Work

SPI: Storm Potential Index

SRB: Sanitary Retention Basin

SRP: Scheduled Replacement Program

SSO: Sanitary Sewer Overflow

Stakeholders: Regional entities involved in or affected by the regional wastewater master plan

Stormwater: Runoff from precipitation including rain and snow melt.

SWWM: Storm Water Management Model

T&O: Taste and Odor

TAC: Technical Advisory Committee

TCR: Total Coliform Rule

TPC: Tournament Players Championship Golf Course in Dearborn

TRC: Technical Review Committee

TSS: Total Suspended Solids as an identified pollutant in sanitary sewage.

USEPA: United States Environmental Protection Agency

VFD: Variable Frequency Drive

VR: Valve Remote

VR-Gates: Valve Remote Gates

WAM: Work and Asset Management

Wastewater Analytics Task Force: One of GLWA's Customer Outreach work groups. It is a community customer team focused on ensuring quality wastewater metering throughout the regional system, collection/analysis of flow data, and collection/analysis of systemic wastewater operational data.

Wastewater System: The entire wastewater system including the Collection System, Linear Assets and all Facilities (pump stations and CSOs) including the GLWA WRRF. This extends to the limits of the GLWA Members' Collection Systems. This term is intended to be used in a general sense to identify the entire regional system and its components.

WMP: Water Master Plan

WMPU: Water Master Plan Update

WQS: Water Quality Standard

WRRF: Water Resource Recovery Facility

WSC: West Service Center

WTP: Water Treatment Plant

WWMP: Wastewater Master Plan

WWTP: Wastewater Treatment Plant (former terminology for WRRF)

Section 11

References

Alliance of Rouge Communities (2013). Mechanisms for Funding Stormwater Management and ARC Membership beyond 2013. Alliance of Rouge Communities

Articles of Incorporation of Great Lakes Water Authority (Excerpt): Article 3 Purpose: The Authority is incorporated for the purpose of acquiring, owning, leasing, improving enlarging, extending, financing, refinancing, and operating a water supply system and a sewage disposal system, including a stormwater collection and treatment system, or a combination of such systems, and for exercising any of the powers of the authority under these articles and for purposes authorized under Article 7, Section 28 of the Michigan Constitution, the Act (Act 233 of 1955) and other Michigan law.

CH2M Hill. Conceptual Drainage Study I-94 Rehabilitation, I-96 to Conner Avenue Detailed Engineering Report (JN 32587) for MDOT

Data Driven Detroit, 2010. Detroit Residential Parcel Survey. www.detroitparcelsurvey.org

Detroit Blight Removal Task Force. 2014. Every Neighborhood Has a Future and It Doesn't Include Blight. Detroit Blight Removal Task Force Plan.

Detroit Future City, 2012. 2012 Detroit Strategic Framework Plan.

Detroit Water and Sewer Department – The First 300 years. The Detroit Water and Sewerage Department. (On line accessed 3/13/2018) Available
http://dwsd.org/downloads_n/about_dwsd/history/complete_history.pdf

Detroit Water and Sewerage Department, 2003 Wastewater Master Plan. Prepared by Camp Dresser and McKee. DWSD Project CS-1314. <http://www.glwater.org/planning-documents/master-plans/>

Detroit Water and Sewerage Department, 2015 Impervious Cover Mapping. Prepared by Sanborn

Detroit Water and Sewerage Department, 2015 Water Master Plan Update. Prepared by CDM Smith. DWSD Project CS-1528. <http://www.glwater.org/planning-documents/master-plans/>

Detroit Water and Sewerage Department, Green Stormwater Infrastructure Annual Report 2011. Retrieved from <http://detroitmi.gov/How-Do-I/Find/Annual-Report>.

Detroit Water and Sewerage Department, Green Stormwater Infrastructure Annual Report 2012. Retrieved from <http://detroitmi.gov/How-Do-I/Find/Annual-Report>.

Detroit Water and Sewerage Department, Green Stormwater Infrastructure Annual Report 2013. Retrieved from <http://detroitmi.gov/How-Do-I/Find/Annual-Report>.

Detroit Water and Sewerage Department, Green Stormwater Infrastructure Annual Report 2014. Retrieved from <http://detroitmi.gov/How-Do-I/Find/Annual-Report>.

Detroit Water and Sewerage Department, Green Stormwater Infrastructure Annual Report 2015. Retrieved from <http://detroitmi.gov/How-Do-I/Find/Annual-Report>.

Detroit Water and Sewerage Department, Green Stormwater Infrastructure Annual Report 2016. Retrieved from <http://detroitmi.gov/How-Do-I/Find/Annual-Report>.

Detroit Water and Sewerage Department, Green Stormwater Infrastructure Annual Report 2017. Retrieved from <http://detroitmi.gov/How-Do-I/Find/Annual-Report>.

Fourth National Climate Assessment (NCA4), 2018. <https://nca2018.globalchange.gov/>

Great Lakes Integrated Sciences and Assessments (GLISA), 2019: Climate Change in the Great Lakes Region. <http://glisa.umich.edu/media/files/GLISA%202020Pager%202019.pdf>

Great Lakes Commission. Michigan Volunteer River, Stream and Creek Cleanup Program. Michigan Department of Environment, Great Lakes, and Energy (EGLE)

Great Lakes Water Authority Wastewater Treatment Plant, Wet Weather Operational Plan, January 01, 2017 Update

Great Lakes Water Authority, GLWA Master Plan, Capacity Evaluation Process Parameters, March 2018

Great Lakes Water Quality Agreement of 1978, United States/Canada, International Joint Commission, signed November 22, 1978

Harman, W.A., T.B. Barrett, C.J. Jones, A. James, and H.M. Peel. 2017. Application of the Large Woody Debris Index: A Field User Manual Version 1. Stream Mechanics and Ecosystem Planning & Restoration, Raleigh, NC.

HNTB and OHM, 2015. Watershed Management Conceptual Drainage Study Report, I-94 Modernization, I-96 – Connor Avenue. Prepared for MDOT.

JFNew. (2006). A Primer on Large Woody Debris, Prepared for the City of Rochester Hills, Michigan.

Incinerator Temperature Data Analysis Charts, CDM Smith, March 2018

Investment in Reducing Combined Sewer Overflows Pays Dividends, Southeast Michigan Council of Governments, 2008.

Macomb County Public Works Office, 2008. Procedures and Design Standards for Stormwater Management.

<http://m.publicworks.macombgov.org/sites/default/files/content/government/publicworks/pdfs/MacombCountyDesignStandardsFinal-ADOPTED-07-30-08Final-PrintingVersion.pdf>

Macomb County Public Works Office, Clinton River Watershed Council, Tetra Tech, Field Manual on Maintenance of Large Woody Debris for Municipal Operation and Maintenance Crews. Prepared for the Clinton River Watershed.

Michigan Department of Environmental Quality, 2013. Detroit Water and Sewerage Department and Great Lakes Water Authority National Pollutant Discharge Elimination System Permit. Permit No. MI0022802. http://www.glwater.org/wp-content/documents/procurement/npdes/dwsd_wwtp_npdes_permit_2016.pdf

Michigan Department of Environmental Quality. 2018 (On line accessed 3/9/2018) Available <https://www.mi.gov/deqnpdes>

National Fish and Wildlife Foundation, Freshwater Conservation Program. <https://www.nfwf.org/whatwedo/themes/Pages/freshwater.aspx>

NCA4, 2018 citation: Diffenbaugh, N. S., M. Scherer, and R. J. Trapp, 2013: Robust increases in severe thunderstorm environments in response to greenhouse forcing. *Proceedings of the National Academy of Sciences of the United States of America*, 110 (41), 16361–16366. doi:10.1073/pnas.1307758110.

NCA4, 2018 citation: Easterling, D. R., J. R. Arnold, T. Knutson, K. E. Kunkel, A. N. LeGrande, L. R. Leung, R. S. Vose, D. E. Waliser, and M. F. Wehner, 2017: Precipitation Change in the United States. *Climate Science Special Report: Fourth National Climate Assessment, Volume I*. Wuebbles, D. J., D. W. Fahey, K. A. Hibbard, D. J. Dokken, B. C. Stewart, and T. K. Maycock, Eds., U.S. Global Change Research Program, Washington, DC, USA, 207–230. doi:10.7930/J0H993CC

NCA4, 2018 citation: Feng, Z., L. R. Leung, S. Hagos, R. A. Houze, C. D. Burleyson, and K. Balaguru, 2016: More frequent intense and long-lived storms dominate the springtime trend in central US rainfall. *Nature Communications*, 7, 13429. doi:10.1038/ncomms13429.

NCA4, 2018 citation: Fritsch, J. M., R. J. Kane, and C. R. Chelius, 1986: The contribution of mesoscale convective weather systems to the warm-season precipitation in the United States. *Journal of Climate and Applied Meteorology*, 25 (10), 1333–1345. doi:10.1175/1520-0450(1986)025<1333:tcomcw>2.0.co;2.

NCA4, 2018 citation: Schumacher, R. S., and R. H. Johnson, 2006: Characteristics of U.S. extreme rain events during 1999–2003. *Weather and Forecasting*, 21 (1), 69–85. doi:10.1175/waf900.1.

NCA4, 2018 citation: Vose, R. S., D. R. Easterling, K. E. Kunkel, A. N. LeGrande, and M. F. Wehner, 2017: Temperature Changes in the United States. *Climate Science Special Report: Fourth National Climate Assessment, Volume I*. Wuebbles, D. J., D. W. Fahey, K. A. Hibbard, D. J. Dokken, B. C. Stewart, and T. K. Maycock, Eds., U.S. Global Change Research Program, Washington, DC, USA, 185–206. doi:10.7930/J0N29V45.

Neff, B.P., A.R. Piggott, and R.A. Sheets, 2005. “Estimation of Shallow Ground-Water Recharge in the Great Lakes Basin.” USGS Scientific Investigations Report 2005–5284 <http://pubs.usgs.gov/sir/2005/5284>

Oakland County Water Resources Commissioner. 2015. Engineering Design Standards for Stormwater Facilities. https://www.oakgov.com/water/Documents/2015/wrc_engineering_design_standards_for_storm_water_facilities.pdf

Permit Compliance Analysis, CDM Smith, March 2018

Revised Great Lakes Water Quality Agreement of 1978, as amended by Protocol, signed November 18, 1987 and consolidated by the International Joint Commission.

Riparian Corridor Management Technical Advisory Committee. (2005). Woody Debris Management 101 and 201, Friends of the Rouge

Rossman, L.A., 2015. Storm Water Management Model Reference Manual, Volume I - Hydrology. EPA/600/R-15/162. <http://nepis.epa.gov/Exe/ZyPDF.cgi?Dockey=P100NYRA.txt>

Rossman, L.A., 2015. Storm Water Management Model User's Manual, Version 5.1. EPA-600/R-14/413b. <http://nepis.epa.gov/Exe/ZyPURL.cgi?Dockey=P100N3J6.txt>

Southeast Michigan Council of Governments (SEMCOG), Population and Household Estimates for Southeast Michigan, 2017

Southeast Michigan Council of Governments (SEMCOG), Precipitation Intensity-Duration-Frequency under Future Climate, SEMCOG Region, Michigan, 2019

State of Michigan Legislature. The Drain Code of 1956, Act 40, 1956. (On line accessed 3/9/2018) Available
[http://www.legislature.mi.gov/\(S\(z3xyta55ko23eyy254olt55\)\)/documents/mcl/pdf/mcl-Act-40-of-1956.pdf](http://www.legislature.mi.gov/(S(z3xyta55ko23eyy254olt55))/documents/mcl/pdf/mcl-Act-40-of-1956.pdf)

State of Michigan Legislature. Excerpt Michigan Natural Resources and Environmental Protection Act Michigan Legislature - Act 233 of 1955, Municipal Sewage and Water Supply Systems. 124.282 Incorporation of authority by municipalities; purpose; adoption of articles of incorporation; endorsement; territory; publishing and filing articles of incorporation; effective date; presumption of validity. (On line accessed 4/12/2018). Available
[http://www.legislature.mi.gov/\(S\(pg0ziiul1kqfrof4vry02sn\)\)/mileg.aspx?page=getObject&objectName=mcl-124-282](http://www.legislature.mi.gov/(S(pg0ziiul1kqfrof4vry02sn))/mileg.aspx?page=getObject&objectName=mcl-124-282)

State of Michigan Legislature. Excerpt Michigan Natural Resources and Environmental Protection Act Michigan Legislature - Act 451 of 1994. 324.31202 Watershed Alliance. (On line accessed 3/13/2018). Available
[http://www.legislature.mi.gov/\(S\(oliisfrok44feol3pco3pwyr\)\)/mileg.aspx?page=getobject&objectname=mcl-324-31202](http://www.legislature.mi.gov/(S(oliisfrok44feol3pco3pwyr))/mileg.aspx?page=getobject&objectname=mcl-324-31202)

Sutherland, R. C. 1995. "Methodology for estimating the effective impervious area of urban watersheds." *Watershed Protection Techniques*, 2(1), 282-284.

The Rouge River Area of Concern – Beneficial Use Impairments Delisting Strategy 2012. Alliance of Rouge Communities. (On line accessed 3/9/2018). Available
<http://www.allianceofrougecommunities.com/PDFs/PI/Final%20Revised%20Strategy%20Report050812.pdf>

United States. Army. Corps of Engineers, Omaha District (2018). Wyoming Stream Quantification Tool, User Manual (version 1.0). U.S. Army Corps of Engineers, Omaha District, Wyoming Regulatory Office.

U.S. Department of Commerce, 2012. Michigan: 2010 Population and Housing Unit Counts 2010 Census of Population and Housing. Publication CPH-2-24

U.S. EPA: Impaired Waters and TMDLs 2017. (On line accessed 3/9/2018). Available <https://www.epa.gov/tmdl/program-overview-impaired-waters-and-tmdls>

USEPA: National Pollutant Discharge Elimination System (NPDES). 2018. (On line accessed 3/09/2018) Available <https://www.epa.gov/npdes>

Wastewater Master Plan, DWSD, October 2003

Wastewater Planning Users Group, 2002. Code of Practice for the Hydraulic Modelling of Sewer Systems. www.ciwem.org/wp-content/uploads/2016/05/Code-of-Practice-for-the-Hydraulic-Modelling-of-Sewer-Systems.pdf

Wastewater Treatment Plant Data Analysis Charts, CDM Smith, March 2018

Water Master Plan, DWSD, September 2015

Wayne County Michigan, 2015. Storm Water Management Program. Stormwater Management Standards (v 3.0)
<https://www.waynecounty.com/departments/environmental/waterquality/standards-manual.aspx>

Woody Debris Management BMP Factsheet, Massachusetts Department of Environmental Protection, Massachusetts Clean Water Tool Kit

WSP/Parsons Brinkerhoff, SmithGroup JJR, 2016. Future 375; I-375 Alternatives Study. Prepared for the City of Detroit Downtown Development Authority in association with the Detroit Riverfront Conservancy and the Michigan Department of Transportation

