



CIP

2024-2028

CAPITAL IMPROVEMENT PLAN

Updated January 19, 2023

Appendix D:

System Background Information



Pump Station 1 Ferric Chloride Storage Tank #3
Photo submitted by: Khoder Daher of Wastewater Operating Services



Water Works Park Water Treatment Plant Yard Piping, Valves, and Venturi Meters Replacement
Photo submitted by: Jacob Magnum of Water and Field Services

APPENDIX D

1. GLWA WATER SYSTEM

The regional water system draws its water from the largest fresh water source in North America, the Great Lakes, with Lake Huron to the north, the Detroit River to the south and Lake St. Clair to the east. With access to nearly 2 billion gallons of high quality source water and with three separate intakes, the Authority has highly reliable and more than sufficient source water for current and projected demands.

The major components of the regional water system include three intake facilities, five treatment plants, an extensive conveyance system consisting of 816 miles of transmission mains throughout the service area, 19 booster pumping stations and 32 water storage reservoirs (14 at the water treatment plants and 18 at booster stations). Water flow and pressure throughout the Water System are monitored and controlled by a Systems Control Center located in the Central Services Facility.

PHYSICAL FACILITIES

INTAKE FACILITIES

The Water System’s three intake facilities are listed below and are generally in adequate to good working order and repair.

- The **Lake Huron intake**, located in Lake Huron, approximately 5 miles north of Port Huron and 5 miles into the lake, was placed in operation in 1974. This intake supplies raw water through a tunnel to the Lake Huron Water Treatment Plant.
- The **Belle Isle intake**, located at the eastern end of Belle Isle where Lake St. Clair flows into the Detroit River, was placed in operation in 1931. This intake supplies raw water to the Water Works Park, Springwells and Northeast Water Treatment Plants.

- The **Fighting Island intake and tunnel**, located under the Detroit River on the Canadian side just west of the northern end of Fighting Island, was placed in operation in 1964. This intake supplies raw water to the Southwest Water Treatment Plant.

WATER TREATMENT PLANTS

Raw water from the intake facilities is treated at the regional water system’s water treatment plants, which includes screening, filtering, bacteria control, and taste and odor control. Each of the five water treatment plants in the regional water system was constructed with the capability to treat the water in accordance with federal requirements under the Safe Drinking Water Act. In the opinion of the Authority, based upon physical evaluations conducted by its consultants, no significant improvements to the water treatment plants are presently required to meet such requirements. In addition, each treatment plant is equipped with its own laboratory facilities for the examination of drinking water which are recertified periodically (every three years) by the Michigan Department of Public Health. The treatment plants are more particularly described in the following table. A summary of the treatment plants is shown in Table 1.

Table 1. Treatment Plant History and Rated Capacity

PLANT	PLACED IN OPERATION	MAXIMUM RATED CAPACITY (MGD)
Lake Huron	1974	400
Southwest	1964	240
Northeast	1956	300
Springwells	1931/1958	540
Water Works Park	2003	240

WATER DELIVERY SYSTEM

The Authority operates and maintains a regional water system consisting of 816 miles of main including most of the transmission mains within the City limits and certain transmission mains throughout the wholesale service area. The regional water system connects with the transmission and distribution mains owned and operated by the wholesale municipal member partners including the City of Detroit.

The transmission system is laid out to provide adequate pressures that are reinforced by use of booster stations and reservoirs, where necessary. Much of the transmission system is interconnected and flow of water can be controlled, particularly in emergency conditions, to flow in either direction by opening or closing valves. Water pressures can be boosted to overcome typical losses due to an emergency situation.

MONITORING FACILITIES

The Water System Control Center controls and monitors the transmission of water throughout the regional water system. Operators in the Systems Control Center can remotely control the pump stations at the treatment plants and the 19 booster stations to adjust flows and pressures to meet the changing demands of member partner communities.

REGIONAL WATER SYSTEM MASTER PLAN

The Water Master Plan Update was accepted by the GLWA Board on August 24, 2016. This plan was materially completed in 2015 (the “2015 Water Master Plan Update” or the “Update”) with final closeout in 2016. Member Partner communities were engaged in the preparation of the 2015 Water Master Plan Update. This provided a broader perspective utilizing the region’s entire infrastructure for public benefit to leverage existing infrastructure before investing in new infrastructure. The 2015 Water Master Plan Update has been utilized to develop the Regional Water System CIP.

The 2015 Water Master Plan Update, which covers a period of 20 years, instead of the 50 years of prior master plans, recognizes the national trend of declining demand. A key focus was to establish a strategic infrastructure and operating plan associated with this reality. The update recommended right-sizing the capacity of the regional water system based on the current lower projections of population and water volumes.

The 2015 Water Master Plan Update found that the Authority’s combined water treatment plant design capacity was estimated to be over 60 percent greater than the forecasted 20-year water demands. The total rated capacity of the existing five water treatment plants is 1.7 billion gallons per day. The 2015 Master Plan Update identified likely maximum demands in the range of up to 1.0 billion gallons per day during the 20- year planning period. This provided the rationale to evaluate the possibility of repurposing one or more water treatment plants to strategically align capacity and service requirements and planning for structural de-rating of capacity as warranted at the remaining four water treatment plants. The 2015 Master Plan Update recommended converting the existing Northeast Water Treatment Plant into a storage and pumping facility, thereby eliminating the need to invest in improvements that would otherwise be required to maintain rated capacity, and investing in the four remaining water treatment plants.

The 2015 Water Master Plan Update is designed to provide the System with flexibility to meet multiple growth scenarios and regulatory changes in the future, furthering GLWA’s sustainability goals. Realigning water treatment plant capacity with forecasted demands will require additions and modifications to the existing water transmission system. The first five years of the 2015 Water Master Plan Update contain several capital projects related to the additions and modifications to the existing water transmission system, a number of which are in the GLWA 2024-2028 CIP. An example of the update’s financial benefits is an estimated \$400 million of capital cost avoidance. In August 2016, the 2015 Water Master Plan Update was further updated to decommission and repurpose the

Northeast Water Treatment Plant, provide a new transmission system serving the Authority’s northeast service area and add enhanced water System redundancy and long-term serviceability to a large (96 inch) water main through completion of a repair, relocation and isolation valve installation project for that water main.

SERVICE AREA AND MEMBER PARTNERS

The Authority currently provides wholesale water services in a service area encompassing 981 square miles and serves all or a portion of eight Michigan counties in southeast Michigan, including Oakland, Macomb, Wayne, Lapeer, Genesee, Washtenaw, St. Clair and Monroe Counties.

Figure 1 displays GLWA’s service area. Approximately 4 million people, or nearly 40 percent of the total population of the State of Michigan, live in the Authority’s water service area. Suburban member partners comprise approximately 82 percent of the population served by the Authority, and the City of Detroit comprise the remainder served by the Authority.

Under certain circumstances, subject to the Authority’s System optimization guidelines, the Authority’s water service area may be expanded to include additional communities. The Authority’s member partner communities are served via wholesale service contracts and the City retail customer class is served via the terms of the Water and Sewer Services Agreement.

WHOLESALE WATER MEMBER PARTNERS

The member partners of the regional water system include 127 communities served through various forms of contracts. The City of Detroit is served pursuant to the Water and Sewer Services Agreement. To date, model contracts for 78 of the 88 wholesale member partners have been negotiated, approved, and are in effect. Of the other 10 wholesale member partners, 7 are served under older contract structures, the Genesee County Drain Commissioner is served via a 30- year Reciprocal Backup Water Service Contract and 2 members receive water services on a non-contract basis.

The 78 member partners served by the new model contracts comprise over 92% of total billed revenues from regional water system wholesale member partners (exclusive of Detroit).

The model water service contracts generally provide for (i) delivery of water by the Authority to the wholesale member partner at designated metered points at specified rates of flow and pressure and (ii) payment by the wholesale member partner for all water supplied at reasonable charges established by the Authority. The Authority is responsible for meeting all water quality requirements at the designated metered points. The wholesale member partner is solely responsible for distributing water from the points of delivery to its retail customers, for local billing, collection and rate setting.

The model contracts have a 30-year initial term and automatically renew for an additional 10-year term unless a party to the contract provides written prior notice of intent to

terminate at least five years prior to the end of the then-current contract term. In the event of an early termination, the model contract provides that wholesale member partners are liable to GLWA for the payment of any costs incurred by the Authority related to the provision of services to the member partner community, unless the termination is for cause, in which case GLWA has cure rights. The model contract provides that GLWA has no responsibility for distributing, operating, repairing, replacing or maintaining any portion of the member partner community’s retail water or wastewater system, that GLWA shall be the sole supplier of service to the member partner’s service area and that the member partner is prohibited from commingling Authority water with water from any other source without the prior approval of GLWA.

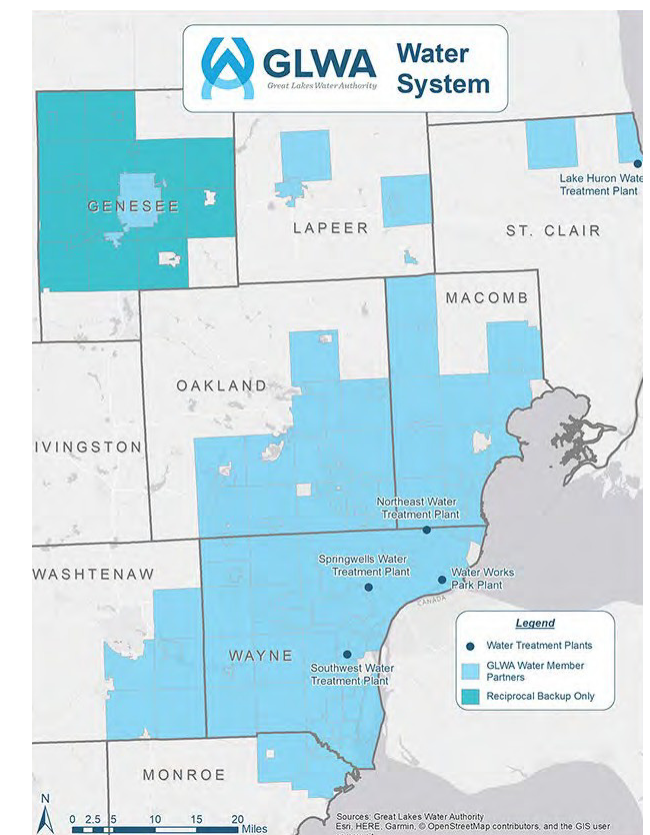

Figure 1. GLWA Water Service Area

The model contracts also provide that the Water Technical Advisory Committee (the “TAC”), established to facilitate a cooperative working relationship between GLWA and its member partner communities, will remain in place for the contract term. In addition, the model contracts include other provisions required for the orderly operation of an integrated water supply and distribution system such as the following: (i) restrictions on redistribution outside the limits of the particular municipality or other public entity without the consent of the Authority; (ii) measurement of water furnished by meters; (iii) the metered flow of water is the basis for billing; (iv) prohibition against combining of regional water system supplied water with water from any other source without prior written approval of the Authority to ensure a uniform quality of water throughout the area; (v) municipal acceptance of the Authority’s standards for construction of distribution mains and Authority approval of construction plans therefor to ensure a uniform standard throughout the area; (vi) Authority commitments regarding notification of rate changes; (vii) payment and late payment terms; (viii) delineation of maintenance responsibilities; (ix) specific water pressure commitments by the Authority; and (x) maximum day, peak hour and annual volume commitments by the wholesale member partner.

1.1. WATER TREATMENT PLANTS & FACILITIES

GLWA operates and maintains five water treatment facilities that provide water to GLWA member partner communities in Southeast Michigan. The Springwells, Northeast, Southwest, Lake Huron, and Water Works Park

Water Treatment Plants have a maximum rated treatment capacity of 1,720 million gallons per day and firm high service pumping capacity of 2,400 million gallons per day. The high service pumping capacity exceeds the rated treatment capacity to assist in meeting peak hourly demands from finished water storage. Applicable treatment and pumping capacities and other data can be seen in Table 2 on the following page.

Four of the five plants (Northeast, Springwells, Southwest and Water Works Park) are conventional treatment facilities with the following process trains: rapid mix, coagulation, flocculation, sedimentation, granular media filtration, and disinfection. Lake Huron is the only facility operated as a “modified direct filtration” plant, which means the sedimentation basins do not require a minimum detention time of 4 hours. In addition, Water Works Park is the only plant that employs intermediate ozonation for primary disinfection control. All five plants use the same chemical systems including alum for coagulation, chlorine for pre-oxidation and primary disinfection (excluding Water Works Park), powdered activated carbon (PAC) for taste and odor (T&O) control, phosphoric acid for corrosion control, and fluoride for dental health protection. Polymers are also added at several facilities to enhance coagulation and filtration as well as for thickening and dewatering of alum residuals. Two of the five plants, Southwest and Water Works Park, employ automated residuals removal from the sedimentations basins. The residuals are thickened and dewatered on site along with backwash wastewater, and disposed of at landfills. Lake Huron’s basins are cleaned manually on an annual basis and the sludge is discharged to the sludge drying lagoons. The lagoons

also receive thickened solids from the waste wash water treatment facility, which processes filter backwash wastewater. The Springwells and Northeast plants do not have automated alum residuals collection in the sedimentation basins or a thickening treatment process on site for alum residuals or backwash wastewater. At both facilities, the basins have been manually cleaned on an annual or biannual basis and the solids discharged to the wastewater collection system; backwash wastewater is also discharged to the wastewater collection system.

Table 2. Water Treatment Plant Capacity, Finished Water Storage and Areas Served Summary

FACILITY	YEAR PLACED IN SERVICE	RATED MAXIMUM TREATMENT CAPACITY (MGD)	FIRM HIGH SERVICE PUMPING CAPACITY (MGD)	TOTAL FINISHED WATER STORAGE VOLUME (MG)	AREAS SERVED
Springwells WTP	1931 First Train; 1958 Second Train	540(1)	260, IPD* 450, HPD*	60	Detroit, Northern Wayne County, Eastern Washtenaw County, Oakland County, Southeastern Macomb County, Western Wayne County
Northeast WTP	1956	300	400	30	Northeast Detroit/Wayne County, Southern Macomb County, Southeast Oakland County
Southwest WTP	1964	240	310	30	Southern Wayne County, Northern Monroe County, Eastern Washtenaw County
Lake Huron WTP	1974	400	420	44	Genesee County, Lapeer County, St. Clair County, Macomb County, Oakland County
Water Works Park WTP	2003	240	560	28	Eastside of Detroit, Eastern Wayne County
SYSTEM TOTALS:		1,720	2,400	192	*IPD = INTERMEDIATE PRESSURE DISTRICT, HPD = HIGH PRESSURE DISTRICT

1.1.1 LAKE HURON WATER TREATMENT PLANT

The Lake Huron Water Treatment Plant began full-scale operations in 1974. The plant is located at 3993 Metcalf Road in Fort Gratiot, Michigan. The Lake Huron plant was designed to be easily expandable to meet the needs of growing populations in the communities it serves to the north of Detroit. In 2004, after completion of a pilot study along with various upgrades to the process trains, the MDEQ rated the maximum capacity of Lake Huron at 400 MGD. Lake Huron is the only GLWA facility that is operated in “modified” direct filtration mode. The sedimentation basins do not meet 10-State standards and thus are not considered to be true settling basins by the MDEQ. The raw water source for the

plant is Lake Huron. The raw water tunnel is designed for a maximum capacity of 1200 MGD and 800 MGD during cold weather. The plant was constructed with provisions to increase the capacity by adding additional process trains and pumping units to obtain the maximum production capacity of 1200 MGD. In the early 2000’s a variety of process treatment improvements were constructed at the Lake Huron Water Treatment Plant. These improvements included new high lift and backwash water pumps (including discharge piping and valves), rehabilitation of two clear wells and the high service suction well, filtration capacity improvements, pretreatment improvements and filter control modification, and a new treatment facility for filter backwash wastewater.

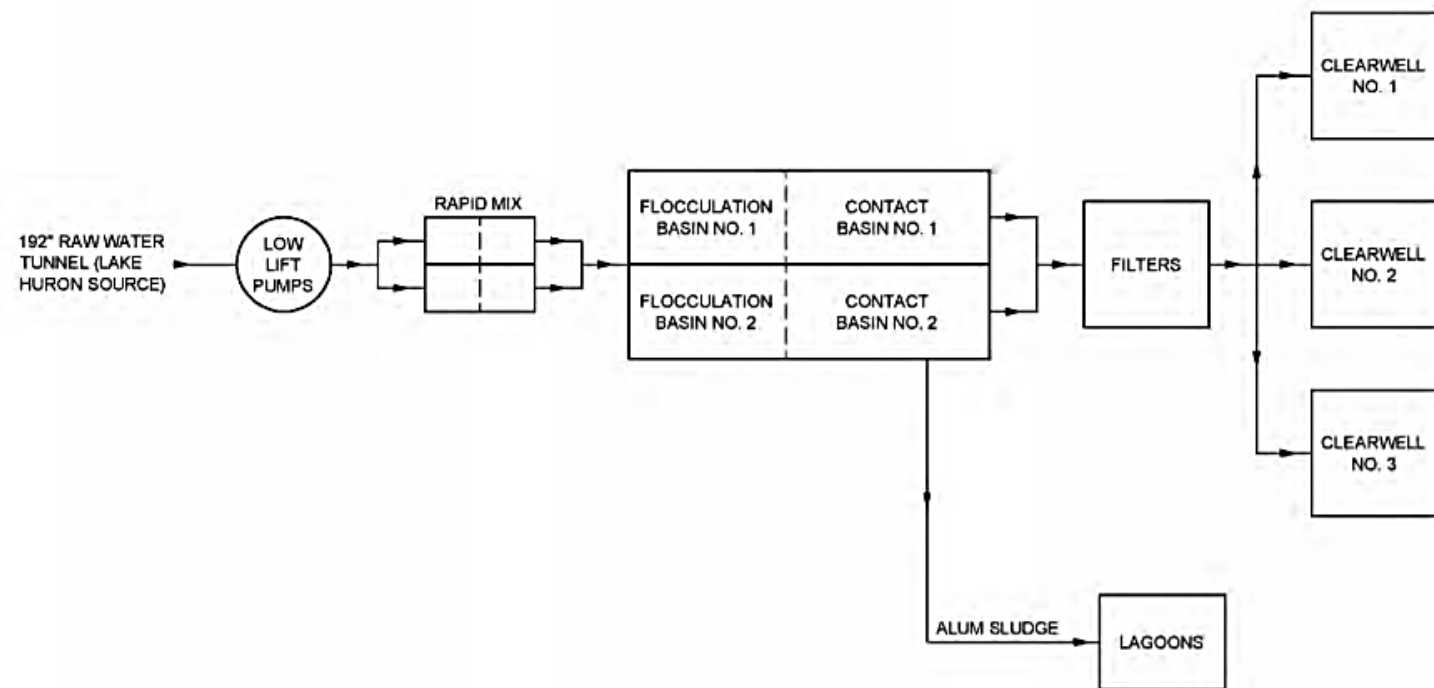

Figure 2. Lake Huron WTP process diagram



Figure 3. Lake Huron WTP

1.1.2. NORTHEAST WATER TREATMENT PLANT

The Northeast Water Treatment Plant at 11000 E. Eight Mile Road in Detroit became the former Detroit Water System’s third water treatment plant. Dedicated in 1956, the plant was built to meet the needs of suburban communities located east and north of the city. The source of raw water is the Belle Isle

intake, located in the Detroit River, which also serves Springwells and Water Works Park. The raw water is chlorinated, fluoridated and screened at Water Works Park before it flows to Northeast by gravity. Low lift pumps lift the raw water to the process trains, which operate in parallel. With a maximum rated capacity of 300 MGD, the plant process trains consist of rapid mix, flocculation, sedimentation, and dual-media gravity filtration.



Figure 5. Northeast WTP

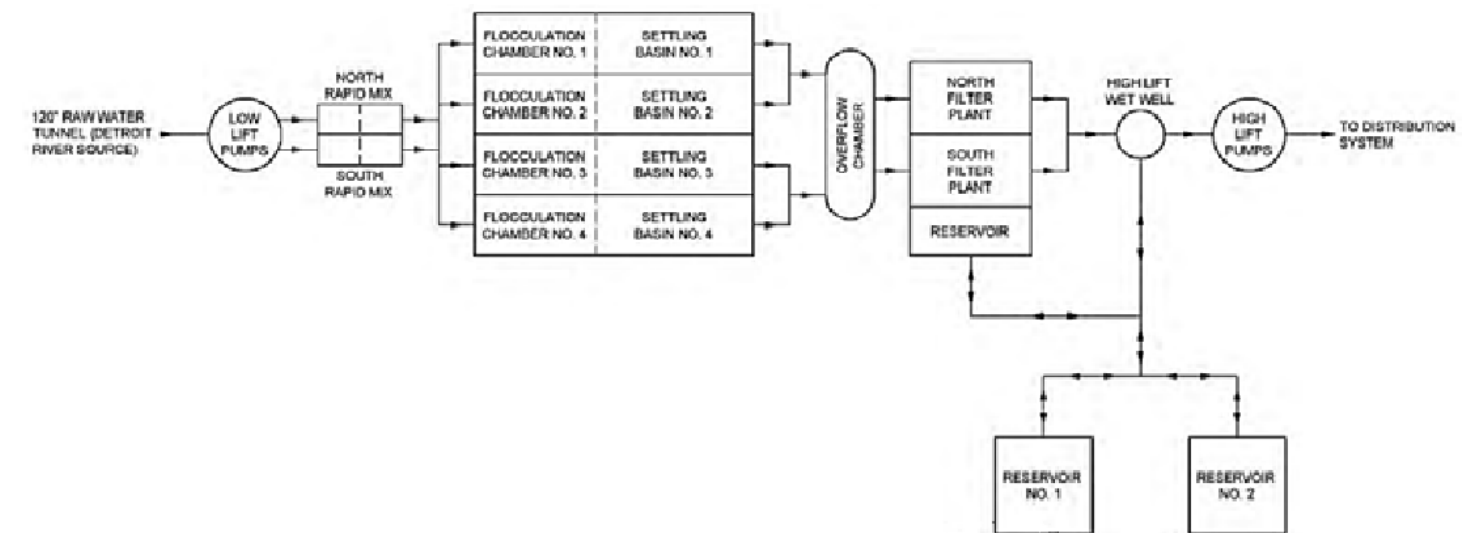

Figure 4. Northeast WTP Process diagram

1.1.3. SOUTHWEST WATER TREATMENT PLANT

Detroit’s fourth water treatment plant, Southwest, located at 14700 Moran Road in Allen Park, became operational in 1964. The Southwest Water Treatment Plant was constructed in 1963, at which time it was owned and operated by Wayne County. Through an agreement with Wayne County, the City of Detroit purchased this plant to regionalize water services in Southeast Michigan. Raw water for Southwest flows by gravity from the Detroit River through an intake at Fighting Island. The plant has a rated capacity of 240 MGD. The original plant was designed with the ability to be upgraded to 320 MGD via equipment replacement. There are also spare raw water conduits that can accommodate an expansion up to 480 MGD. The low lift pumps lift the raw water for

treatment through the process trains, which operate in parallel. The Southwest Water Treatment Plant also has a Residuals Handling Facility to treat filter backwash wastewater and alum sludge residuals.



Figure 6. Southwest WTP

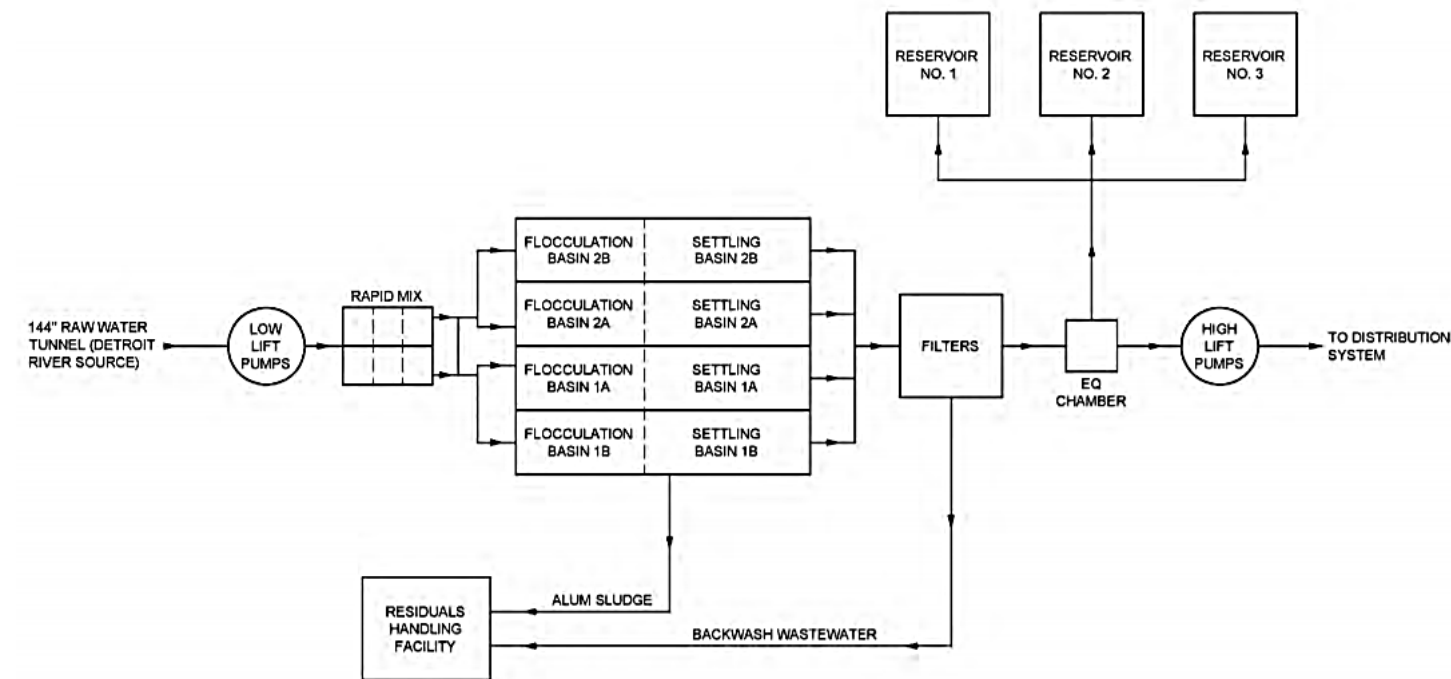

Figure 7. Southwest WTP process diagram

1.1.4. SPRINGWELLS WATER TREATMENT PLANT

The Springwells Water Treatment Plant at 8300 W. Warren Avenue in Dearborn is the oldest of the GLWA water treatment facilities. At the time of its dedication in 1935, it was the largest water treatment facility in the world. The first train was constructed in 1930 and has a maximum rated capacity of 340 MGD and the second train constructed in 1958 has a maximum rated capacity of 200 MGD, for a total capacity of 540 MGD. Like Northeast, the Springwells plant receives its raw water from the Belle Isle Intake. The raw water influent is screened, chlorinated and fluoridated at Water Works Park before it is conveyed to Springwells. The low lift pumps lift the raw water for treatment through the process trains, which operate independently. The 1930 train provides hydraulic mixing through a baffled chamber for rapid mixing while the 1958 train has mechanical rapid mixers. Both trains have flocculation, sedimentation and

filtration treatment units. This project includes a complete replacement of the 1958 filters and a limited replacement of some of the 1930 filters. A laboratory upgrade, yard piping and other site improvements, and electrical improvements are also included in this project.



Figure 8. Springwells WTP

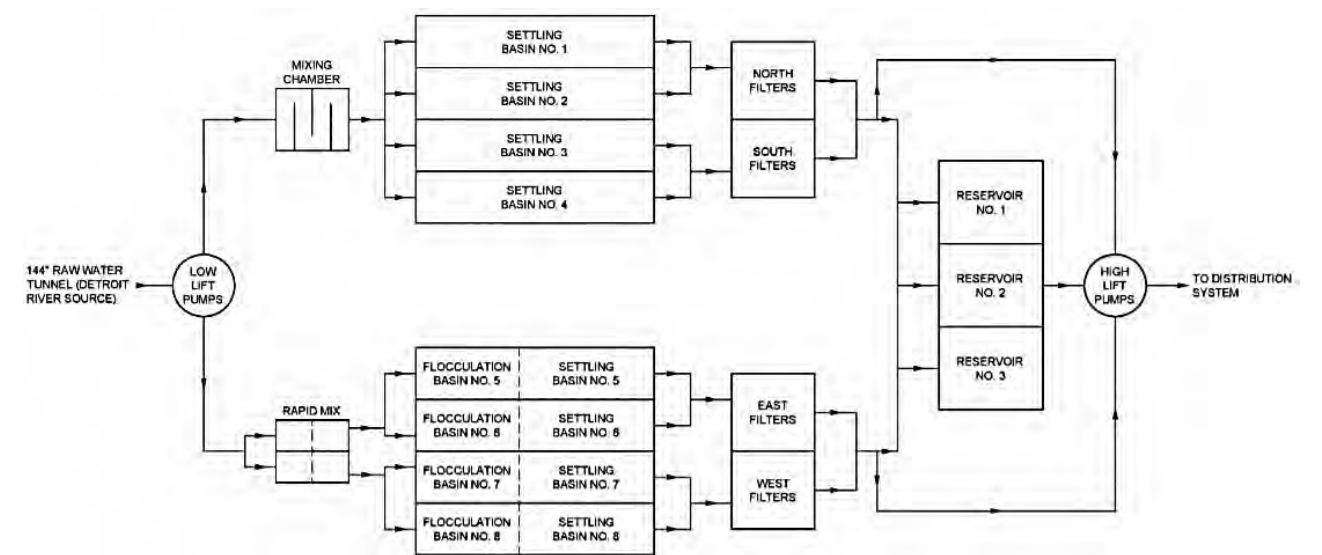

Figure 9. Springwells WTP process diagram

1.1.5. WATER WORKS PARK WATER TREATMENT PLANT

Water Works Park Water Treatment Plant can produce up to 240 million gallons of superior quality drinking water per day (MGD) with room for expansion to 320 MGD. The end result of the city's \$275 million investment in this state-of-the-art facility is water the way it is meant to be: colorless, odorless, and great tasting; even better tasting than the water for which DWSD has been justifiably lauded for more than 150 years.

GLWA's newest water treatment plant is located at 10100 E. Jefferson Avenue in Detroit. Water Works Park II began operating in 2003 as a conventional surface water treatment plant. The original Water Works Park water treatment plant was razed and a new facility was constructed on the same site. The raw water source for the plant is the Belle Isle intake on the Detroit River. The plant has a maximum rated capacity of 240 MGD and is GLWA's first facility with ozone disinfection facilities, as well as a Residuals Handling Facility to treat filter backwash wastewater and alum sludge residuals. Water Works Park is the

largest plant in Michigan to use ozone as a disinfectant. The plant was designed to use independent process trains - a minimum of two process units are provided for each treatment process. In addition, all conveyance facilities such as pipelines, junction chambers, channels, and wet wells are configured to provide a minimum of two treatment pathways. treatment through the process trains, which operate in parallel. The Southwest Water Treatment Plant also has a Residuals Handling Facility to treat filter backwash wastewater and alum sludge residuals.



Figure 10. Water Works Park WTP

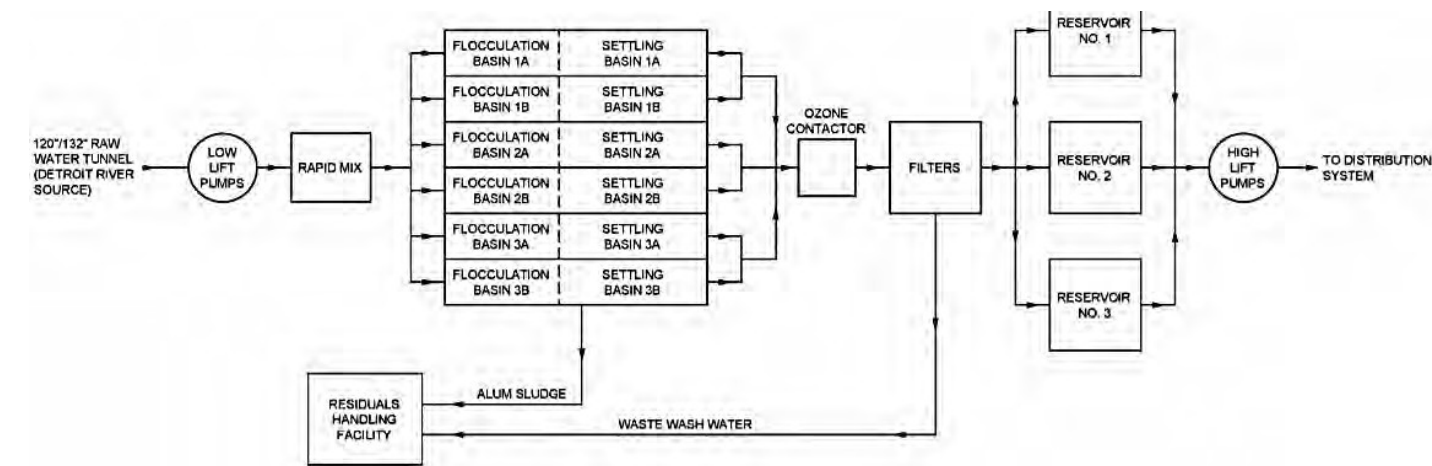

Figure 11. Water Works Park process diagram

1.1.6. GENERAL PURPOSE

The General Purpose category within Project Category 2 and Project Category 3 in the Capital Project/General Ledger Account Numbering Protocol are necessary to identify projects that cross over multiple project categories. Projects that are not specifically attributed to one particular area will be identified here.

1.2 FIELD SERVICES

1.2.1. GENERAL PURPOSE

The General Purpose category within Project Category 2 and Project Category 3 in the Capital Project/General Ledger Account Numbering Protocol are necessary to identify projects that cross over multiple project categories. Projects that are not specifically attributed to one particular area will be identified here.

1.2.2. TRANSMISSION SYSTEM

The Regional Water Transmission System (RWTS) consists of approximately 803 miles of water main typically 24-inch and greater with the responsibility for the transport of potable water from the five water treatment facilities to the regional wholesale water member partner communities and the City of Detroit.

Figure 12, Figure 13, and Figure 14 depict the potable transmission main inventory by material, diameter, and decade installed/age, respectively. The RWTS ranges from 4 to 120 inch in diameter with an average age of 69 years. Additionally, there are approximately 23 miles of raw water transmission main ranging from 120 to 186 inch in diameter supplying the five water treatment plants from the three raw water intakes.

Most of RTWS is Prestressed Concrete Cylinder Pipe (54%), Cast Iron Pipe (19%), and Steel Pipe (17%). The majority of RTWS are typically 24 inches and larger, of which 24 inch (20%), 42 inch (15%), and 48 inch (13%) are the most common diameters; however, some smaller diameter pipe exists on site at the treatment and pumping facilities and limited areas of the system to maintain needed connectivity. Detroit and the region went through several growth periods of time evidenced by the greatest periods of water main installation of the 1960s (32%), 1920s (19%) and 1950s (11%).

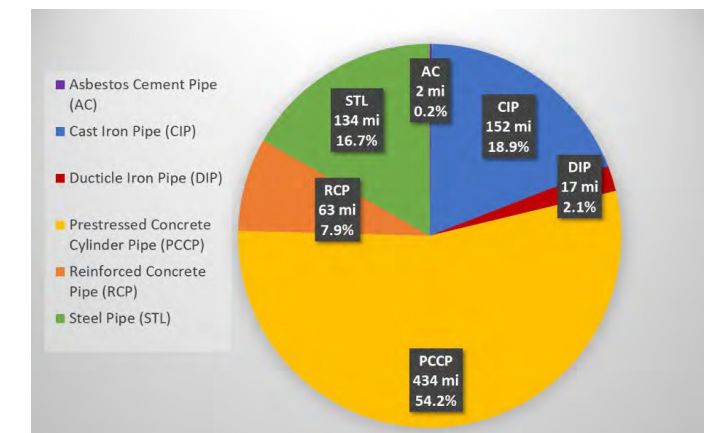

Figure 12. Transmission system inventory by material

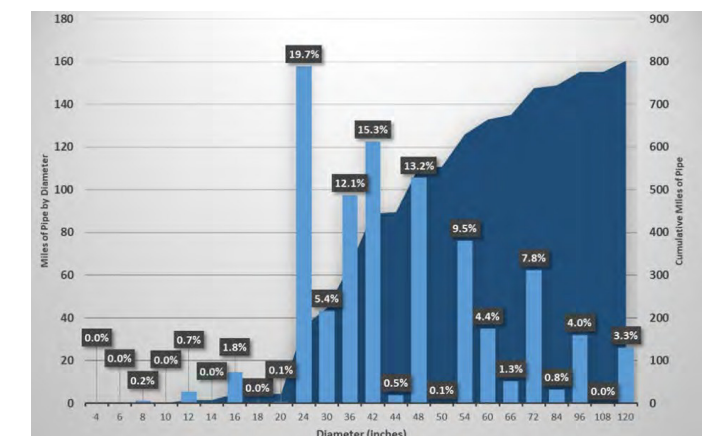

Figure 13. Transmission system inventory by diameter

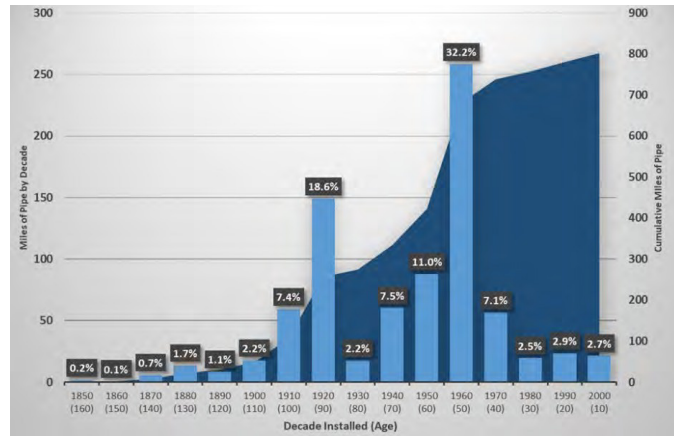

Figure 14. Transmission system inventory by decade installed / age

Water Transmission Main Pipe Integrity Program

Given the large transmission main size (24-inch and greater) and the significant population served, pipeline failures have a significant consequence. Previously, a traditional approach to manage deteriorating pipes has been to perform large-scale capital improvement projects to replace the mains. However, this strategy has been shown to be resource-consuming and often ends with the replacement of pipes that may still have significant remaining useful life. GLWA has chosen a more fiscally responsible asset management strategy to implement a pipeline integrity program, which consists of condition assessment and targeted repair, replace or renewal of pipelines to mitigate the risk of pipe failure.

In this predictive approach, refer to **Figure 15**, GLWA's implementation of the pipe integrity program will minimize both the probability and consequence of pipeline failures. The program includes a pipeline risk assessment of each transmission main to determine the priority, as well as recommendations on implementation

and execution of a condition assessment and renewal program. This baseline risk assessment of GLWA's transmission system was accomplished by calculating the consequence and probability of failure for each pipeline operated by GLWA, then prioritizing the pipelines based on the total risk. It is anticipated that GLWA's holistic pipeline integrity program will minimize transmission failures overall, however due to the nature of buried pressure pipe, some pipe breaks may not be preventable, regardless of the intensity of the program. As such and like most utility owners, GLWA will continue to be exposed to the risk of pipeline failure. Operational practices that minimize the consequences of a pipe break, such as a valve exercising program or maintaining a minimum inventory of replacement pipes, continue to be in place. Each segment of transmission main planned for assessment has both capital and O&M related projected expenses. The capital expenses related to actual repairs of the pipe resulting from the assessment or from the installation of monitoring equipment are accounted for within the CIP. O&M budget related items consist of projected expenses related to the planning of the condition assessment itself, development of a detailed inspection plan, contingency and communication plan for each segment, performing the actual condition assessment and any annual monitoring fees for the installed assessment equipment. A significant effort is required within each pipe assessment to communicate and coordinate activities with member partners to ensure continuity of service to the extent possible during the assessment. In addition, it is critical to evaluate appropriate technologies and approaches to successfully perform the condition assessment that provides an appropriate level of

information while maintaining the highest water quality and levels of service.

Figure 18 depicts only those water transmission mains operated/maintained (leased) by GLWA within the City of Detroit. **Figure 19** depicts the water transmission mains operated/maintained (leased) by GLWA over the entire service area. The suburban communities own, operate, and maintain all of their transmission and distribution systems from the points of connection to the RWTS.

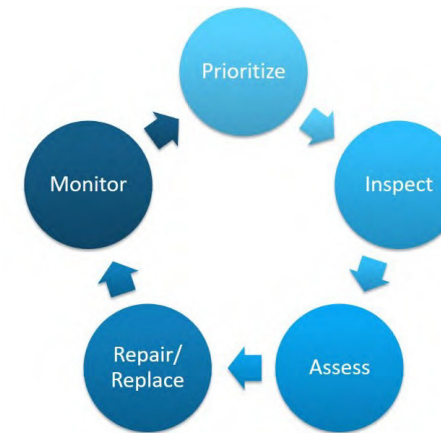

Figure 15. Proposed transmission system program cycle

1.3. SYSTEM CONTROL CENTER

1.3.1. GENERAL PURPOSE

The General Purpose category within Project Category 2 and Project Category 3 in the Capital Project/General Ledger Account Numbering Protocol are necessary to identify projects that cross over multiple project categories. Projects that are not specifically attributed to one particular area will be identified here.

Pressure Reducing Valve (PRV)

Pressure Reducing Valves (PRV) regulate water pressure at critical locations throughout the Regional Water Transmission System. Pressure reduction is needed to protect

portions of the Water System from being impacted by above normal operating pressures. Downstream of the PRVs, pressure is maintained at a relatively consistent lower pressure.

Pressure Monitoring Site

Fifty-three Pressure Monitoring Sites in the transmission system provide suction/upstream and discharge/downstream pressure readings to aid in system operation.

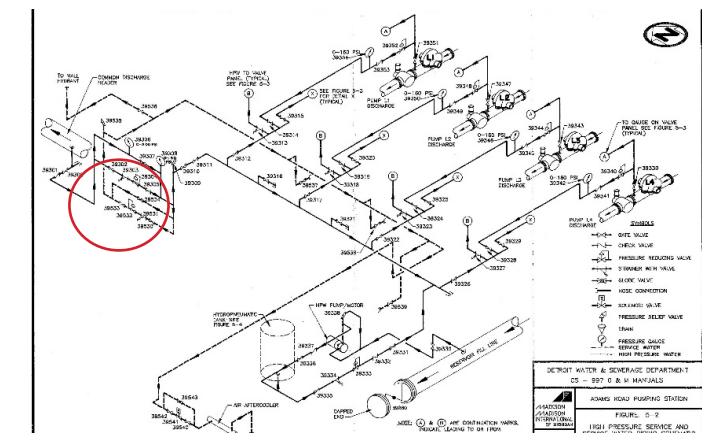

Figure 16. Adams Road Pumping Station: PRVs can be seen throughout drawing. The one circled for example reduces pressure before feeding to service water line.

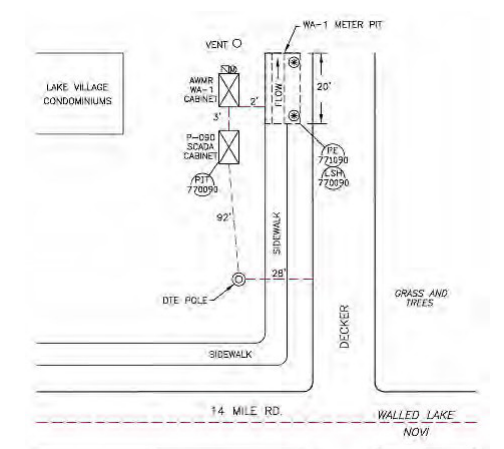
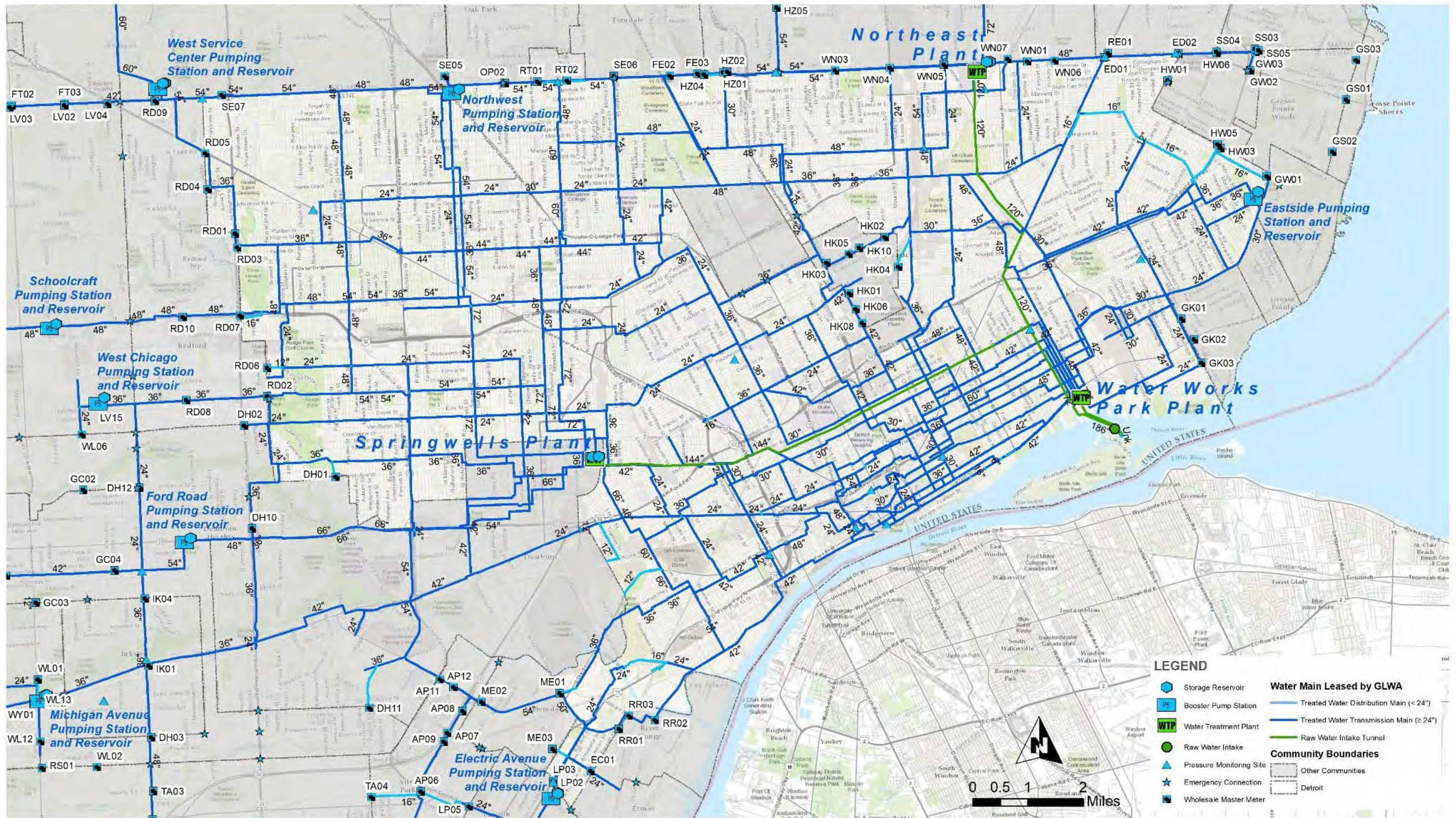

Figure 17. Pressure Monitoring Site at 14 Mile and Decker



**GLWA LEASED WATER ASSETS - INSIDE CITY OF DETROIT
REGIONAL WATER TRANSMISSION SYSTEM**

Notes: Assets depicted on this map are based on the best available data at this time. They may not be completely accurate including spatial representations, leased statuses or attribute values. The user accepts responsibility for accuracy of any referenced information, spatial or otherwise.

Figure 18. GLWA Leased Water Assets inside the City of Detroit

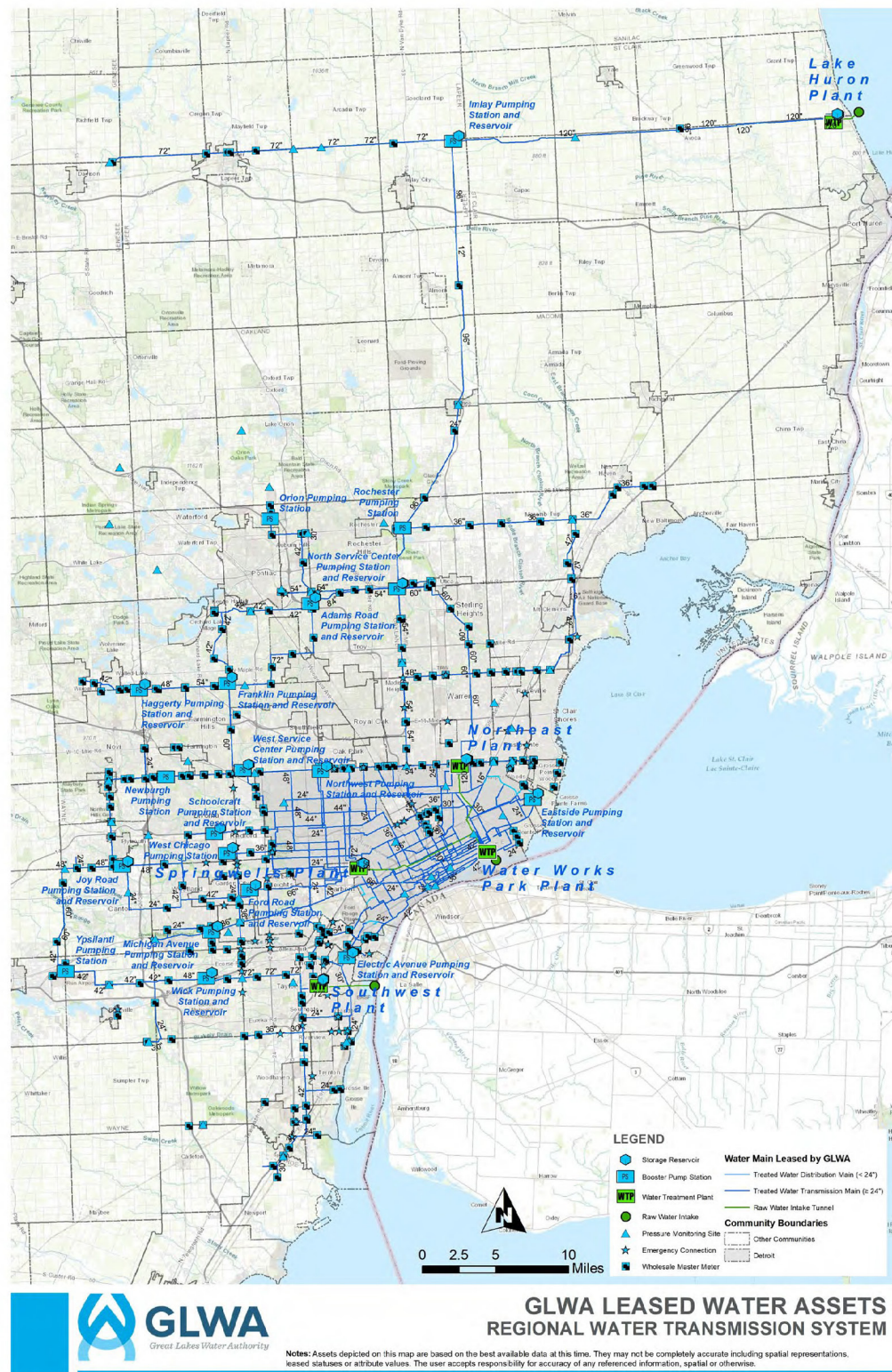

Figure 19 . GLWA Leased Regional Water Assets

1.3.2. GENERAL PURPOSE

Booster stations are located within the regional System and distribute water received from the Water Treatment Facilities to communities and other stations to meet pressure and demand requirements. Some water is diverted to reservoirs at the station until needed during times of high demand. Pumping stations re-pump the water in transmission mains and reservoirs to maintain these pressures. There are 19 water booster stations in the GLWA transmission system.

Adams Road Pump Station

The Adams Road Station consists of a pump house and a primary unit substation. The station's purpose is to increase the pressure in the 42- inch water main running along Adams Road. The station is fed by the North Service Center Station, which receives its water from the Lake Huron Water Treatment Plant through the Imlay Station. The discharged water from the station flows north through the 42-inch water main along Adams Road. The station serves the member partner communities of Rochester Hills, Auburn Hills, Pontiac, as well as Bloomfield Hills and West Bloomfield, during high demand periods.

Elevation	881.50
Suction Pressure	40 - 55 PSI
Discharge Pressure	120 -150 PSI
Reservoir Capacity	10 MG
Reservoir Pumps	R1 - 1500 HP, 10 MGD, 350 TDH R2 - 1500 HP, 10 MGD, 350 TDH
Line Pumps	L1 - 750 HP, 18.2 MGD, 191 TDH, VFD L2 - 750 HP, 18.2 MGD, 191 TDH L3 - 750 HP, 18.2 MGD, 191 TDH L4 - 750 HP, 14 MGD, 191 TDH
Electric Feeds	2



Figure 20. Adams Road Pump Station

East Side Pump Station

The Eastside Pump Station consists of a pump house and a reservoir. The purpose of the station is to store water during the off-peak hours and use the stored water to supplement the supply during the hours of high demand. The discharged water from the station flows through the 36- inch water main along Canyon Avenue. The station serves the communities of East Detroit and Grosse Pointe.



Figure 21. Eastside Pump Station

Elevation	579.26
Suction Pressure	
Discharge Pressure	55 - 70 PSI
Reservoir Capacity	10 MG
Line Pumps	R1- 350 HP, 10 MGD, 350 TDH R2- 350 HP, 10 MGD, 350 TDH R3- 350 HP, 10 MGD, 350 TDH
Electric Feeds	1

Electrical Avenue Pump Station

The Electric Avenue Pumping Station increases the water pressure in the 36-inch water main running along Electric Avenue. The station receives its water from the intermediate pressure district of the Southwest Water Treatment Plant. Water from Electric Avenue Pump Station serves the communities of Lincoln Park, Southgate, Riverview, and Trenton.



Figure 22. Electric Avenue Pump Station

Elevation	577.71
Suction Pressure	55 - 70 PSI
Discharge Pressure	55 - 80 PSI
Reservoir Capacity	2 X 3.3 MG
Reservoir Pumps	R3 - 200 HP, 5.56 MGD, 150 TDH R4 - 300 HP, 5.56 MGD, 150 TDH
Line Pumps	L1 - 100 HP, 5.04 MGD, 75 TDH L2 - 100 HP, 5.04 MGD, 75 TDH
Electric Feeds	2

Haggerty Pump Station

The Haggerty Pumping Station consists of a pump building, 10-million gallon aboveground reservoir, and exterior primary power area. The primary purpose of the station is to boost water pressure and increase flow to the existing water main. The station also has the capacity to provide an emergency supply of water of up to 28 MGD emergency demand in the event of a water main break between Haggerty and Franklin pumping stations. When operating at full capacity during periods of high demand, the Haggerty Pumping Station will boost the transmission system pressure in the existing 42-inch water main serving City of Novi, Commerce Township, City of Walled Lake, City of Wixom, West Bloomfield, and Wolverine Lake.



Figure 23: Haggerty Pump Station

Elevation	880.00
Suction Pressure	55 - 100 PSI
Discharge Pressure	80 - 105 PSI
Reservoir Capacity	10 MG
Reservoir Pumps	R1 - 700 HP, 14 MGD, 200 TDH R2 - 700 HP, 14 MGD, 200 TDH
Line Pumps	L1 - 700 HP, 21 MGD, 100 TDH, VFD L2 - 700 HP, 21 MGD, 100 TDH, VFD L/R3 - 700 HP, 21 MGD, 100 TDH, VFD
Electric Feeds	2

Ford Road Pump Station

The Ford Road Station consists of a pump house and a reservoir that stores water to supplement the normal water supply during high demand periods. The station receives water from the intermediate district of the Springwells Water Treatment Plant. The station increases the pressure in the 48-inch water main running along Ford Road. Dearborn Heights, Garden City, Westland, Inkster, and parts of Canton Township are serviced by Ford Road Pump Station.

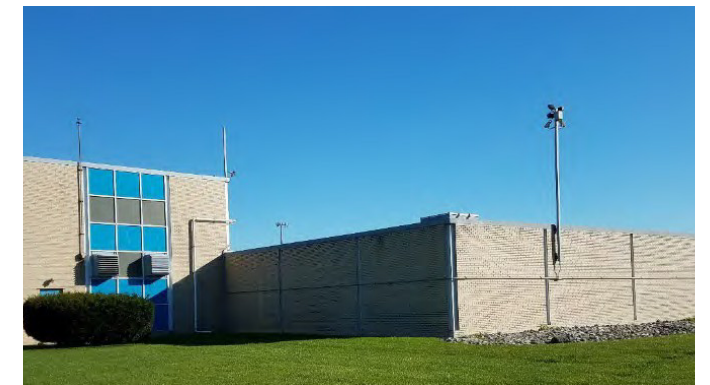

Figure 24: Ford Road Pump Station

Elevation	618.26
Suction Pressure	35 - 50 PSI
Discharge Pressure	75 - 95 PSI
Reservoir Capacity	10 MG
Reservoir Pumps	R6 - 450 HP, 10.08 MGD, 210 TDH R7 - 450 HP, 10.08 MGD, 210 TDH R8 - 450 HP, 10.08 MGD, 210 TDH R9 - 450 HP, 10.08 MGD, 210 TDH R10 - 450 HP, 10.08 MGD, 210 TDH
Line Pumps	L1 - 250 HP, 18.14 MGD, 60 TDH L2 - 250 HP, 10.08 MGD, 120 TDH L3 - 250 HP, 10.08 MGD, 120 TDH L4 - 250 HP, 10.08 MGD, 120 TDH L5 - 250 HP, 10.08 MGD, 120 TDH
Electric Feeds	2

Franklin Pump Station

The Franklin Pumping Station consists of a pump house and reservoir. The station increases pressure in the 42-inch water main running north and the 54-inch water main running south along Inkster Road. The 60-inch main comes from the high pressure district of the West Service Center that, in turn, is fed by the Northeast and Springwells Water Treatment Plants. The station also stores water to supplement normal supply during the peak demand periods. The station serves Farmington Hills, Franklin Township, Bloomfield, and West Bloomfield.



Figure 25. Franklin Pump Station

Elevation	832.58
Suction Pressure	35 - 60 PSI
Discharge Pressure	135 - 155 PSI
Reservoir Capacity	10 MG
Reservoir Pumps	R1 - 1570 HP, 22 MGD, 320 TDH R2 - 1570 HP, 22 MGD, 320 TDH
Line Pumps	L1 - 2000 HP, 30 MGD, 250 TDH L2 - 2000 HP, 30 MGD, 250 TDH L3 - 2000 HP, 30 MGD, 250 TDH L4 - 2000 HP, 30 MGD, 250 TDH
Electric Feeds	2

Michigan Avenue Pump Station

The Michigan Avenue Pumping Station increases the water pressure in the 36-inch water main running along Michigan Avenue. The 36-inch water main is supplied by the intermediate pressure district of the Springwells Water Treatment Plant and when demand requires it, by the Southwest Water Treatment Plant intermediate pressure district. The station also stores water to supplement the normal water supply during peak demand periods. Water from Michigan Avenue Station serves the communities of Canton and Wayne.



Figure 26: Michigan Avenue Pump Station

Elevation	638.10
Suction Pressure	40 - 60 PSI
Discharge Pressure	55 - 75 PSI
Reservoir Capacity	1X 3.5 MG
Reservoir Pumps	R4 - 350 HP, 8.64 MGD, 150 TDH R5 - 350 HP, 8.64 MGD, 150 TDH
Line Pumps	L1 - 75 HP, 3.60 MGD, 90 TDH L2 - 75 HP, 3.60 MGD, 90 TDH L3 - 125 HP, 4.32 MGD, 110 TDH
Electric Feeds	2

Joy Road Pump Station

The Joy Road Pumping Station consists of one pump house, two reservoirs, and one primary unit substation. The purpose of the station is to increase the pressure in the 48-inch water main running along Joy Road. The station is fed by the Ford Road and Schoolcraft stations, which are fed by the Springwells Water Treatment Plant. The discharged water from the station flows west through the 48-inch water main along Joy Road to Sheldon Road. Then, the water main runs north along Sheldon Road to Eight Mile in Northville. The station serves the member partner communities of Plymouth and Northville and the townships of Plymouth, Northville, and Canton.



Figure 27. Joy Road Pump Station

Elevation	686.00
Suction Pressure	35 - 55 PSI
Discharge Pressure	130 - 150 PSI
Reservoir Capacity	2 X 5 MG
Reservoir Pumps	R1 - 1200 HP, 16.13 MGD, 332 TDH R2 - 1200 HP, 16.13 MGD, 332 TDH R3 - 1250 HP, 14.8 MGD, 332 TDH
Line Pumps	L1 - 1050 HP, 15.84 MGD, 288 TDH, VFD L2 - 1050 HP, 15.84 MGD, 288 TDH L3 - 1000 HP, 14.8 MGD, 288 TDH
Electric Feeds	2

Imlay Pump Station

The Imlay Pumping Station consists of a pump house and reservoir. The station maintains the required water pressure in the 72-inch supply line to the Flint area and the 96-inch supply line to North Service Center Pumping Station. The station receives water through a 120-inch water main from the Lake Huron Water Treatment Plant. It also stores water to supplement the water supply during the high demand period. The supply water can bypass the station and go directly from the 120-inch main to the 96- and 72- inch water mains.



Figure 28. Imlay Pump Station

Elevation	787.87
Suction Pressure	65 - 95 PSI
Discharge Pressure	85-W/-75-170-S PSI
Reservoir Capacity	18 MG
Reservoir Pumps	R1 - 5250 HP, 75 MGD, 335 TDH R2 - 5250 HP, 75 MGD, 335 TDH
Line Pumps	LR3 - 6000 HP, 75 MGD, 335 TDH, VFD LR4 - 6000 HP, 70 MGD, 390 TDH LR5 - 6000 HP, 70 MGD, 390 TDH LR6 - 6000 HP, 70 MGD, 390 TDH, VFD LR7 - 6000 HP, 70 MGD, 390 TDH, VFD LR8 - 6000 HP, 70 MGD, 390 TDH, VFD
Electric Feeds	2

Newburgh Pump Station

The Newburgh Pumping Station increases the pressure in the 42-inch water main that runs along Eight Mile from West Service Center intermediate pressure line. This main is fed by the high pressure district of the Northeast and Springwells Water Treatment Plants. Discharged water from the station flows west through the 42-inch water main and serves Livonia, Northville, Novi, and Farmington Hills.



Figure 29. Newburgh Pump Station

Elevation	737.00
Suction Pressure	35 - 60 PSI
Discharge Pressure	110 - 130 PSI
Line Pumps	L1 - 450 HP, 8 MGD, 200 TDH L2 - 450 HP, 8 MGD, 200 TDH L3 - 515 HP, 12 MGD, 200 TDH L4 - 515 HP, 12 MGD, 200 TDH L5 - 515 HP, 12 MGD, 200 TDH
Electric Feeds	2

Northwest Pump Station

The Northwest Pumping Station consists of a pump house and a reservoir. The station stores water during the off-peak hours and uses the stored water to supplement the water supply during the hours of high demand. The discharged water from the station flows north, through the 42-inch discharge header along Greenfield Road, to the Southeastern Oakland County Water Association Pump Station. A 24- inch branch line, running south along Greenfield Road, supplies water to the Springwells high pressure district. A 54-inch branch line, running west along Eight Mile, supplies water to the West Service Center. The station serves the communities of northwest Detroit.



Figure 30: Northwest Pump Station

Elevation	657.00
Suction Pressure	
Discharge Pressure	40-55 PSI
Reservoir Capacity	10 MG
Reservoir Pumps	R1 - 350 HP, 10.08 MGD, 150 TDH R2 - 350 HP, 10.08 MGD, 150 TDH R3 - 350 HP, 10.08 MGD, 150 TDH R4 - 350 HP, 10.08 MGD, 150 TDH R5 - 350 HP, 10.08 MGD, 150 TDH
Electric Feeds	1

North Service Center

The North Service Center receives its water from Lake Huron Water Treatment Plant through the Imlay Station. North Service Center maintains adequate pressure in the 84-inch water main supplying Pontiac and Utica, supplies water to the service area of Northeast Water Treatment Plant and to Eight Mile water main, and stores water during low demand periods to be used to supplement normal water supply during peak periods. North Service Center serves Pontiac, Adams Pumping Station, Utica, Northeast Water Treatment Plant service area, and supplies water to the Eight Mile water main.



Figure 31. North Service Center

Elevation	697.70
Suction Pressure	30 - 50 PSI
Discharge Pressure	135 - 150 PSI
Reservoir Capacity	2 X 10 MG
Reservoir Pumps	R1 - 250 HP, 15 MGD, 75 TDH R2 - 250 HP, 15 MGD, 75 TDH R3 - 350 HP, 20 MGD, 76 TDH R4 - 350 HP, 20 MGD, 76 TDH
Line Pumps	L2 - 2500/1250 HP, 23-30 MGD, 240-370 TDH L3 - 2500/1250 HP, 19.3-25.5 MGD, 260-400 TDH L4 - 2500/1250 HP, 23-30 MGD, 240-370 TDH L5 - 2500/1250 HP, 19.3-25.5 MGD, 260-400 TDH L6 - 2500/1250 HP, 19.3-25.5 MGD, 260-400 TDH L7 - 2500 HP, 30 MGD, 370 TDH, VFD

Line Pumps continued	L8 - 2500 HP, 30 MGD, 370 TDH, VFD L9 - 2500 HP, 30 MGD, 370 TDH, VFD L10 - 2500 HP, 30 MGD, 370 TDH, VFD
Electric Feeds	2

Orion Pump Station

The Imlay Pumping Station consists of a pump house and reservoir. The station maintains the required water pressure in the 72-inch supply line to the Flint area and the 96-inch supply line to North Service Center Pumping Station. The station receives water through a 120-inch water main from the Lake Huron Water Treatment Plant. It also stores water to supplement the water supply during the high demand period. The supply water can bypass the station and go directly from the 120-inch main to the 96- and 72- inch water mains.



Figure 32. Orion Pump Station

Elevation	946.25
Suction Pressure	75 - 95 PSI
Discharge Pressure	105 - 130 PSI
Line Pumps	L1 - 75 HP, 2 MGD, 85 TDH L2 - 75 HP, 4 MGD, 85 TDH L3 - 75 HP, 4 MGD, 85 TDH L4 - 75 HP, 4 MGD, 85 TDH
Electric Feeds	2

Rochester Pump Station

The Rochester Pump Station consists of a pump house and a transformer yard. The station supplies water at an adequate pressure to the City of Rochester Hills and Shelby Township distribution mains. The station replaced a temporary station at the site. It is fed by the Imlay Station, which receives its water from the Lake Huron Water Treatment Plant. Discharged water will boost pressures in communities currently being served by a 36-inch main running east-west along 24 Mile. The station serves City of Rochester Hills, Shelby Township, City of Rochester, Lennox Township, Macomb Township, and Chesterfield Township.

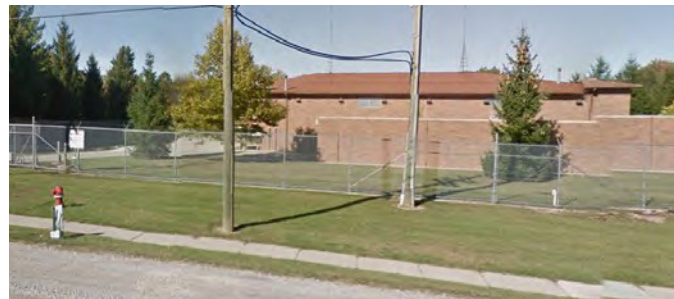

Figure 33. Rochester Pump Station

Elevation	687.00
Suction Pressure	65 - 95 PSI
Discharge Pressure	75 - 140 PSI
Line Pumps	L1 - 700 HP, 14.4 MGD, 205 TDH, VFD L2 - 700 HP, 14.4 MGD, 205 TDH L3 - 700 HP, 14.4 MGD, 205 TDH, VFD L4 - 700 HP, 14.4 MGD, 205 TDH L5 - 700 HP, 14.4 MGD, 205 TDH
Electric Feeds	2

West Service Center

The West Service Center consists of one main pump house, two reservoir pump houses, and two reservoirs. It increases the pressure in the 54-inch water main running along Eight Mile Road, from the high pressure district of the Northeast and Springwells Plants. There are six line pumps in the main pump house. Three line pumps supply high pressure water to the Franklin station and other upstream member partner communities. The three remaining pumps supply the intermediate pressure line, which serves the Newburgh Station, Farmington Station, and other upstream communities. During low demand periods, water is diverted to the reservoirs. During high demand periods, the reservoir water is pumped to the suction header of the line pumps. The intermediate pressure line running along Eight Mile serves Redford Township and Livonia before reaching the Newburgh Station. High pressure lines running along Inkster Road serve the Farmington Hills and Southeast Oakland County Water Association before reaching the Franklin Station.

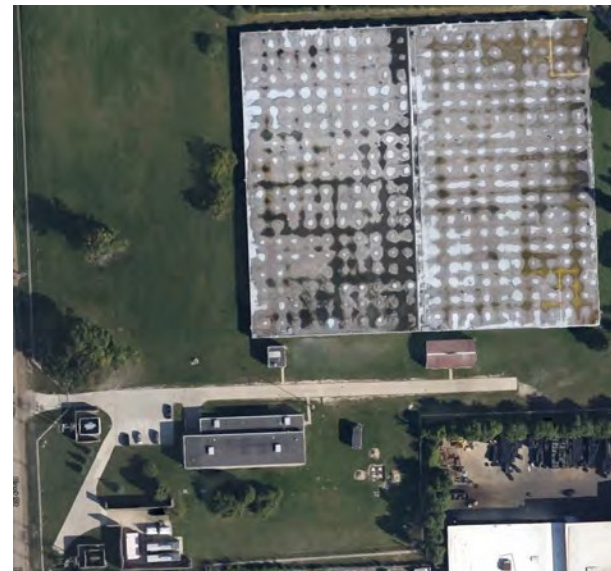

Figure 34: West Service Center

Elevation	646.89
Suction Pressure	35 - 50 PSI
Discharge Pressure	110 - 140 PSI
Reservoir Capacity	2 X 10 MG
Reservoir Pumps	R1 - 400 HP, 24 MGD, 96 TDH R2 - 400 HP, 24 MGD, 96 TDH R3 - 400 HP, 20 MGD, 85 TDH R4 - 400 HP, 20 MGD, 85 TDH
Line Pumps	L1 - 700 HP, 30 MGD, 110 TDH L2 - 700 HP, 30 MGD, 110 TDH L3 - 700 HP, 30 MGD, 110 TDH L4 - 1250 HP, 28.8 MGD, 188 TDH L5 - 1250 HP, 29.5 MGD, 188 TDH
Electric Feeds	2

Schoolcraft Pump Station

The Schoolcraft Pump Station consists of one pump house, an electrical building, one reservoir, and one primary unit substation. The station increases the pressure in the 48-inch water main running along Schoolcraft Road. The station is fed by the Springwells Water Treatment Plant and itself feeds the Joy Road Station. The station serves the City of Livonia and interconnects with the Joy Road Station, which services Canton, Westland, and Plymouth.

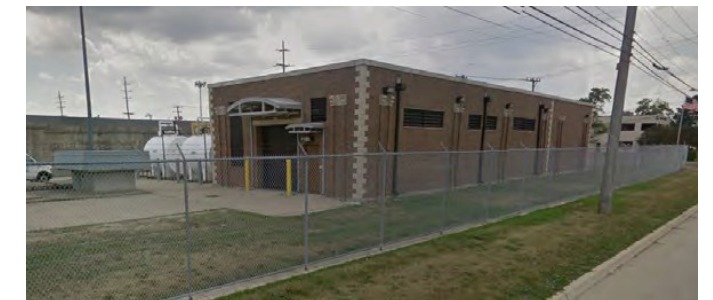

Figure 35. Schoolcraft Pump Station

Elevation	626.83
Suction Pressure	35 - 55 PSI
Discharge Pressure	80 - 110 PSI
Reservoir Capacity	10 MG
Reservoir Pumps	R1 - 1200 HP, 20 MGD, 238 TDH R2/L3 - 1200 HP, 20 MGD, 238 TDH, VFD
Line Pumps	L1 - 1000 HP, 20 MGD, 170 TDH, VFD L2 - 1000 HP, 20 MGD, 170 TDH, VFD
Electric Feeds	2

West Chicago Pump Station

The West Chicago Station increases the water pressure in the 26-inch water main running along West Chicago Road. The 36-inch water main comes from the high pressure district of the Springwells Water Treatment Plant. The station helps increase the pressure in the intake lines for Schoolcraft and Newburgh Stations. Water from the station serves the member partner communities of southern Livonia, West Service Center intermediate district, and Westland.

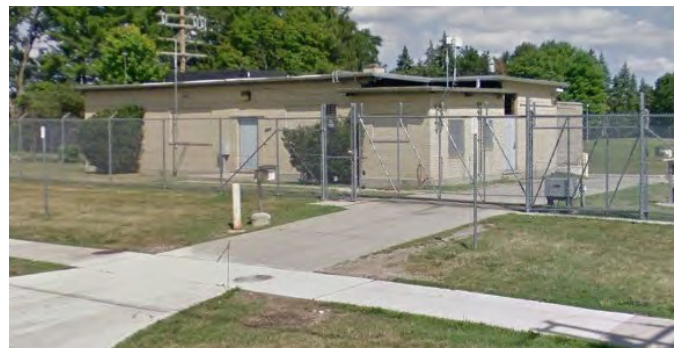

Figure 36. West Chicago Pump Station

Elevation	636.71
Suction Pressure	40 - 60 PSI
Discharge Pressure	70 - 80 PSI
Reservoir Pumps	R4 - 300 HP, 7.2 MGD, 185 TDH R5 - 300 HP, 7.2 MGD, 185 TDH R6 - 300 HP, 7.2 MGD, 185 TDH
Line Pumps	L1 - 300 HP, 7.4 MGD, 180 TDH L2 - 300 HP, 7.4 MGD, 180 TDH L3 - 125 HP, 4.3 MGD, 180 TDH
Electric Feeds	2

Wick Road Pump Station

The Wick Road Station consists of a pump house, a reservoir, and an electrical building. The station increases pressure in the 48-inch water main running along Wick Road. The station is fed mainly by the Southwest Water Treatment Plant, which is affected by the Springwells Plant's intermediate pressure line. The discharged water from the station flows west through the 48-inch water main along Wick Road. The main is reduced to 42 inches and feeds the Ypsilanti Station. A 24-inch branch from the 48-inch main serves the Van Buren, Sumpter, Huron, and Ash Townships. The station serves the member partner communities of Romulus, Belleville, Carleton, Wayne, and Ypsilanti.

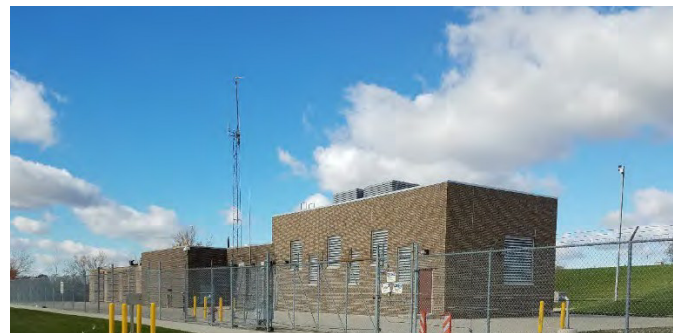

Figure 37. Wick Road Pump Station

Elevation	626.83
Suction Pressure	40 - 60 PSI
Discharge Pressure	80 - 135 PSI
Reservoir Capacity	10 MG
Reservoir Pumps	R1 - 1000 HP, 12 MGD, 238 TDH R2 - 1000 HP, 12 MGD, 238 TDH R3/L3 - 1000 HP, 12 MGD, 238 TDH, VFD
Line Pumps	L1 - 1000 HP, 18 MGD, 252 TDH, VFD L2 - 1000 HP, 18 MGD, 252 TDH, VFD
Electric Feeds	2

Ypsilanti Pump Station

The Ypsilanti Station consists of a pump house and a transformer yard. The station supplies water at adequate pressure to the City of Ypsilanti's distribution mains. It is fed by the Wick Road Station which receives its water from the Southwest Water Treatment Plant's intermediate pressure line. Discharged water from the station flows through the 42-inch water main running along Old Ecorse Road. It serves the City of Ypsilanti as well as Augusta, Pittsfield, and Superior.



Figure 38. Ypsilanti Pump Station

Elevation	636.71
Suction Pressure	40 - 60 PSI
Discharge Pressure	70 - 80 PSI
Reservoir Pumps	R4 - 300 HP, 7.2 MGD, 185 TDH R5 - 300 HP, 7.2 MGD, 185 TDH R6 - 300 HP, 7.2 MGD, 185 TDH
Line Pumps	L1 - 300 HP, 7.4 MGD, 180 TDH L2 - 300 HP, 7.4 MGD, 180 TDH L3 - 125 HP, 4.3 MGD, 180 TDH
Electric Feeds	2

1.4. WATER QUALITY

The Water Quality Group is responsible for the majority of the testing and reporting of water quality throughout the Water System. The Water Quality Group manages the state and federal rules and their application to the entire Water System. Functions include the collection, monitoring and reporting requirements associated with these rules. Total coliform rule (TCR), the consumer confidence rule (CCR) and the lead and copper (LCR) are exclusively managed by the GLWA water quality group for the entire System except in those communities which choose not to participate. The Safe Drinking Water Act (SDWA) rules that apply exclusively to the distribution system, other than TCR and LCR, are the exclusive responsibility of each local water system. Currently the GLWA Water Quality Group performs a majority of its work for the overall benefit of the GLWA System. These functions include water quality testing, member partner response, disinfection services and the overall program management related to the Water System water quality compliance.

1.5. METERING

The System Analytics and Meter Operations Group is responsible for maintenance and operation of numerous remote assets used in the metering of water, as well as the communication network used to transmit data from the water metering locations to the head end.

The System Analytics and Meter Operations Group maintains assets with the responsibility to meter wholesale water usage at 290 metering sites. Each of the 290 water metering sites contain equipment that is located in a control cabinet, as well as assets that are

located in a water meter vault. The assets that are housed in the control cabinet include Remote Terminal Units, radios, batteries, battery chargers and flow transmitters. The assets that are housed in the water meter vault include differential pressure transmitters, venturi tubes, magnetic meters, pressure transmitters, mechanical flow meters, bypass valves, inlet/outlet gate valves, butterfly valves, and sump pumps.

In addition to metering equipment, the System Analytics and Meter Operations Group maintains a 900MHz telemetry network and a Wholesale Automated Meter Reading (WAMR) system. The 900 MHz telemetry network is composed of 445 repeater sites. Each repeater location consists of radios and antennas. The WAMR system collects flow and pressure information from GLWA wholesale water meter sites every five minutes. The portal provides a customizable, web-based interface that displays meter and member partner data in both graphical and tabular formats in increments of five minute, hourly and daily intervals. Member partner and site usage can also be downloaded for off-line examination. Billed Consumption with adjustments can be reviewed for member partner usage analysis.

1.6. GENERAL PURPOSE

The General Purpose category within Project Category 2 and Project Category 3 in the Capital Project/General Ledger Account Numbering Protocol are necessary to identify projects that cross over multiple project categories. Projects that are not specifically attributed to one particular area will be identified here.

1.7. PROGRAMS

Programs consist of the replacement and/or rehabilitation of specific capital asset on an ongoing or reoccurring basis. The program scope and/or projected expenses may vary from year-to-year, depending on the needs identified within the program, and as newly established programs develop consistent schedules, requirements and history over time. Although not typically identified in the CIP future years projected expenses, these programs will typically be funded in perpetuity. The numbering structure of the “Program” category is slightly different in order to allow up to 99 separate projects to be attributable to each program. As discussed previously, these projects identified under a parent program will be issued a CIP number, however will be displayed within the CIP as a phase of the overall parent program.

APPENDIX D

2. GLWA WATER SYSTEM

2.1. WATER RESOURCES RECOVERY FACILITY

The Water Resources Recovery Facility (WRRF, formerly referred to as the Wastewater Treatment Plant or WWTP) is the largest single-site wastewater treatment facility in the United States. Of the more than \$22.5 million spent to ready the plant for its February 1940 startup, \$10 million was spent on plant construction with the balance going to complete the network of huge interceptor sewers through which a combined stream of storm and sanitary wastewater flows to the plant from member partner communities throughout metro Detroit.

The treatment plant was originally designed to provide primary treatment (screening, grit removal, primary sedimentation and chlorination) for the wastewater generated by 2.4 million people and, with modifications, as many as 4 million people. The plant's service area in 1940 included Detroit and 11 nearby suburban communities.

Secondary treatment (biological treatment and secondary clarification for removal of biodegradable solids, resulting in an even cleaner effluent) was introduced in the 1960s. GLWA's WRRF continues to be the recipient of continual upgrades in order to ensure it is capable of staying abreast of ever more stringent regulatory standards.

Currently, the WRRF services the needs of 35 percent of the state's population contained within Detroit and 76 other communities in a service area of more than 946 square miles. In 1999, the Michigan section of the American Society of Civil Engineers named the WRRF one of the top 10 engineering projects of the

20th century.

The WRRF treats, on average, 650 MGD. Currently, the peak rated capacity is 1,700 MGD for primary treatment and 930 MGD for secondary treatment. The WRRF has been in service since 1940, at which time it removed approximately 50-70 percent of the pollutant loads. It was upgraded to full secondary treatment in the 1970s. After the upgrade to secondary treatment, the WRRF removes in excess of 85 percent of the pollutant loads to meet federal and state requirements.

Currently, the WRRF serves approximately 3 million residents in southeast Michigan. The WRRF receives wastewater flow from three main interceptors: the Detroit River Interceptor (DRI), the Oakwood Interceptor (OWI), and the North Interceptor East Arm (NIEA). Approximately 36 percent of the flow comes from the DRI, 35 percent from the OWI, and the remaining 29 percent from the NIEA. After the flow reaches the WRRF via the three interceptors, it is pumped to the primary and secondary treatment processes at Pump Station No. 1 (PS- 1) and Pump Station No. 2 (PS-2). Each pump station has eight pumps with a combined total pumping capacity in excess of 2 billion gallons per day (BGD).

A diagram of the WRRF layout is shown on the following page in **Figure 39**.

2.1.1. PRIMARY TREATMENT

The primary treatment area of the WRRF consists of the following major units:

- Raw wastewater pumping to Pump Station No. 1 (PS-1) and Pump Station No. 2 (PS-2), grit and screenings removal, and chemical addition.
- 12 Rectangular Primary Clarifiers

- 6 Circular Clarifiers
- 7 Rectangular Clarifier Scum Buildings
- 6 Circular Clarifier Scum Buildings
- Rectangular Clarifier Pipe Gallery (including 12 Sludge Pumps)
- 6 Rectangular Clarifier Electrical/Mechanical Buildings 3 Circular Clarifier Sludge Pumping Stations
- 1 Scum Concentrator Building 1 Thin Sludge Pumping Station
- Miscellaneous Hydraulic Structures and Gates

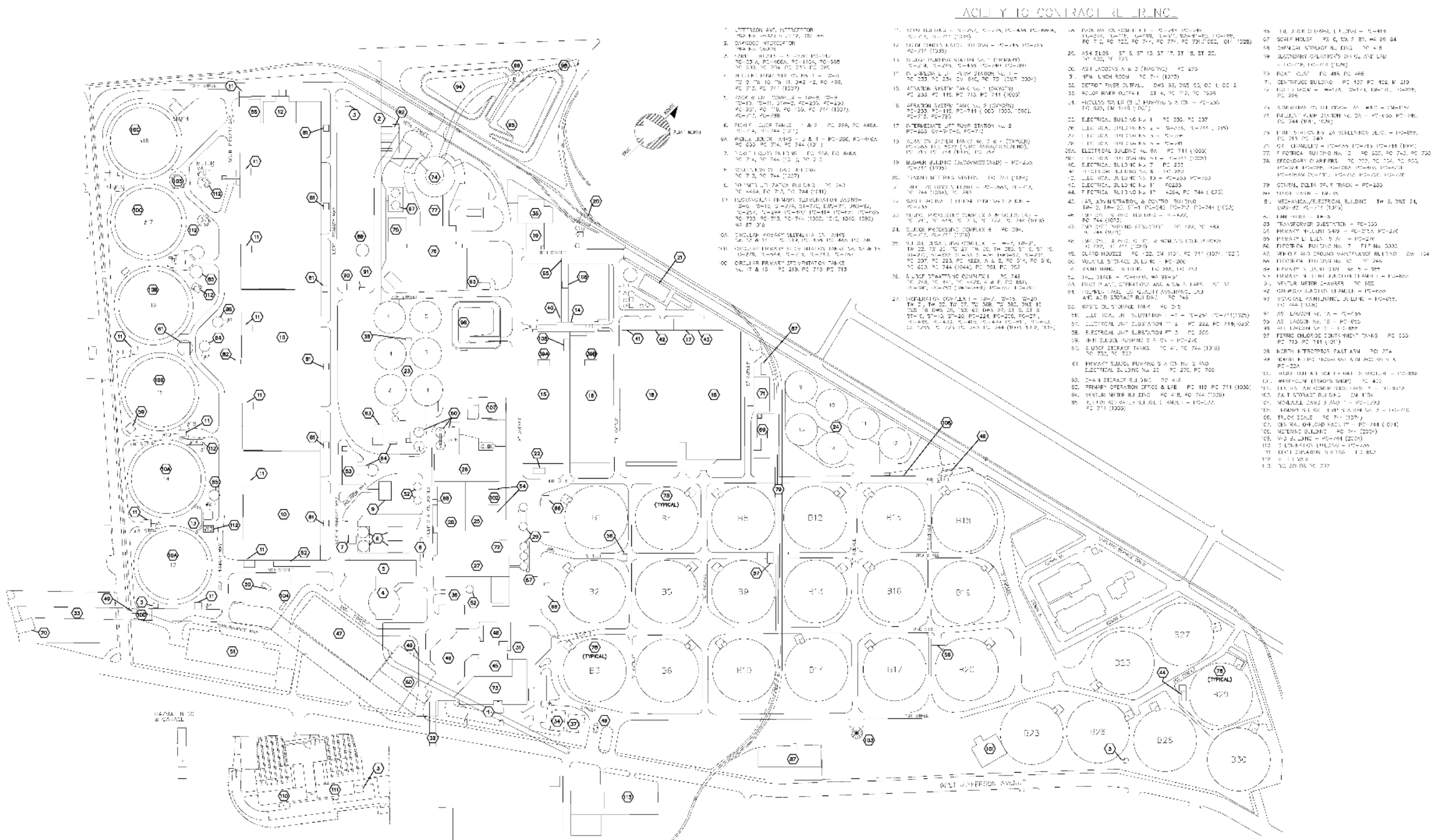

Figure 39. Water Resource Recovery Facility Layout

Wastewater from PS-1 and PS-2 flows by gravity to the rectangular and circular primary clarifiers. Under normal dry weather flow conditions, the rectangular clarifiers typically receive flow from PS-1, while the circular clarifiers typically receive flow from PS-2, and all the primary effluent receives secondary treatment. Under wet weather conditions, a portion of the flow from PS-1 may need to be directed to the circular clarifiers to meet the permit primary flow requirement of 1,700 MGD. The permit requires that flow up to 930 MGD be directed to secondary treatment and that flow above 930 MGD receive chlorination and be discharged through the Detroit River Outfall.

2.1.2. SECONDARY TREATMENT & DISINFECTION

The secondary treatment area of the WRRF consists of the following major units (continued after next page):

- ILP Station No. 1 with ILP Nos. 1 and 2
- ILP Station No. 2 with ILP Nos. 3, 4, and 7
- Four Covered Oxygen Tanks (Aeration Deck Nos. 1, 2, 3 and 4)
- One Oxygen Gas Delivery Pipeline
- One Cryogenic Oxygen Production Plant
- Twenty-five Circular Final Clarifiers
- Chlorination/Dechlorination/Outfalls
- Intermediate pumping (ILP Station Nos. 1 and 2). Secondary treatment using high purity oxygen activated sludge tanks and 25 secondary clarifiers.
- Disinfection of the final effluent using chlorination and dechlorination.

The Intermediate Lift Pumps (ILPs) lift primary effluent from the Primary Effluent to Activated Sludge (PEAS) Tunnel to the aeration decks. Primary effluent is mixed with return activated sludge at the head of each aeration basin. Aeration Basins Nos. 1 through 4 employ a

high purity oxygen activated sludge process. All required oxygen for the aeration system is supplied by Praxair through a dedicated pipeline. The Praxair pipeline ends at a metering station located where the old T-180 Cryogenic Plant was located (this plant was demolished as part of DWP-1013). From the metering station, an oxygen piping system ties into each aeration deck and the liquid oxygen backup system.

Four covered aeration decks use high purity oxygen for biological treatment. Aeration Deck Nos. 1 and 2 each have 10 bays, while Aeration Deck Nos. 3 and 4 have eight bays each. The volume of each aeration deck is approximately 17.8 million gallons. Oxygen is fed to the headspace at the first bay of each deck. High efficiency aerators dissolve oxygen into the wastewater and keep the mixed liquor in suspension. Primary effluent and return activated sludge (RAS) enter at the first bay of each aeration deck. All decks are equipped with mixers, a purge blower, oxygen feed and vent valves, an oxygen flow meter, and Lower Explosive Limit (LEL) and dissolved oxygen monitoring equipment.

Each aeration deck has a rated capacity of 310 MGD (+50 MGD RAS). The plant typically maintains three decks in service at all times to be able to meet the required wet weather flow of 930 MGD through secondary treatment. The fourth deck is always offline and acts as a backup. Aeration Deck No. 1 was converted to a pure oxygen system, and Aeration Deck Nos. 2, 3, and 4 were rehabilitated in 2004 through 2006 under DWP-1005 “Aeration Deck Conversion and Rehabilitation.”

The mixed liquor flows by gravity from

the aeration decks and is distributed to the secondary clarifiers for solids/water separation. Variable speed vertical wet pit pumps return the activated sludge from the clarifiers to the aeration decks. Sludge is wasted on a continuous basis from the return activated sludge to Complex B gravity thickeners. The secondary effluent is chlorinated and dechlorinated before discharge to the river through the Detroit River Outfall (DRO). As indicated above, the secondary treatment capacity is 930 MGD during wet weather. The 930 MGD capacity is based on the following assumptions:

- 3 out of 5 ILPs each at 310 MGD
- 3 out of 4 aeration decks each at 310 MGD
- 23 of 25 clarifiers each at 40.4 MGD

The conversion of Aeration Basin No. 1 to high purity oxygen in 2004 increased its capacity from 150 MGD to a maximum of 310 MGD, providing the plant with any one basin as backup capacity. Additionally, the replacement of ILP Nos. 1 and 2 and modification to their flow metering installation under DWP-2004, increased their maximum pumping capacity from 260 MGD to 365 MGD during the year 2004. These improvements have, therefore, provided GLWA adequate redundancy to allow the maintenance staff to schedule shutdowns of aeration basins or ILPs to conduct preventive maintenance throughout the year regardless of weather conditions.

2.1.3. RESIDUALS MANAGEMENT

Solids generated in primary and secondary treatment are gravity- thickened in separate facilities for primary sludge and thickened waste activated sludge for drying and disposal. A portion of the thickened sludge is pumped to the new Biosolids Drying Facility (BDF). The

thickened solids are dewatered using both high solids centrifuges and belt filter presses (BFPs). Portions of the dewatered solids are incinerated. The remainder of the dewatered solids are offloaded after lime addition to trucks for either land application or landfill disposal.

2.1.4. INDUSTRIAL WASTE CONTROL

The Authority’s Industrial Waste Control (IWC) Division, located at 303 S. Livernois, is responsible for implementing and enforcing city and federal regulations pertaining to the pretreatment of industrial wastewater.

Industrial Waste Control charges are assessed to all commercial and industrial end users that send wastewater to the GLWA wastewater treatment plant. The IWC charges are to offset the costs incurred in administering regulatory activities under the Sewer Use Ordinance/ Industrial Waste Control Ordinance as required in the National Pollutant Discharge Elimination System (NPDES) Permit Program and the Clean Water Act (CWA). There is a delegation Agreement with each community to collect the industrial waste control charges from the end-users even though most communities are contracting agency member partners to the wholesale sewer contract member partner.

In addition to the IWC Charges, a commercial or industrial end user may also have to pay pollutant surcharges if they discharge high-strength wastewater into the System that has compatible pollutant levels higher than is allowed for domestic sources. The IWC Group evaluates users and does testing to identify those users that have excess pollutants. The charges are used to offset the higher chemical and treatment costs for these excess pollutants in the wastewater.

2.1.5. CSO RTB & SDF

The Authority provides treatment at Combined Sewer Overflow (CSO) Retention Treatment Basins (RTB) and Screening and Disinfection Facilities (SDF) on many of its largest outfalls to provide for removal of floatable material and disinfection of wastewater prior to discharge. The CSO basins are also designed with storage capacity to contain a volume of wastewater from each storm event, including the first flush of the storm. When the storm event subsides, the captured flows are pumped back through the system for treatment at the WRRF.

GLWA operates eight of the 18 CSO control facilities tributary to GLWA's Regional Sewer System in Wayne, Oakland and Macomb Counties as prescribed in a lease agreement. The facilities are an outgrowth of the Long-Term CSO Control Plan, started in 1993 to address CSO discharges from 78 outfalls along the Detroit and Rouge Rivers. Of the eight facilities, five are CSO RTBs and three are SDFs. The location of CSO RTBs and SDFs assets can be found on **Figure 51** on page 53. The Belle Isle CSO RTB is operated as prescribed in a shared services agreement.

Combined Sewer Overflow Retention Treatment Basins

CSO control is needed because the Sewer System can become overloaded during heavy rain events. In older, large metropolitan areas like Detroit, combined sewers are used to transport both wastewater and storm water in the same pipe. During rainstorms, these sewers can receive many times the volume of flow that is normally transported on a dry day. CSO control facilities adequately treat these excess flows during wet weather in

accordance with the GLWA EGLE NPDES permit. Conversely, newer communities have two separate sewer systems: one to handle wastewater flow and the other for storm flow. A CSO retention treatment basin (RTB) is a storage tank that captures flow equal to its volume during a wet-weather event. Flow to an RTB in excess of its volume is screened and disinfected prior to discharge out of an RTB outfall. Flows are injected with Sodium Hypochlorite disinfectant to kill bacteria before discharging to receiving waters (Detroit and Rouge Rivers). Materials removed by the screens are sent to the WRRF or hauled to a landfill for proper disposal. The stored flows are sent to the WRRF after the storm has subsided and capacity is available in the sewer system. During smaller wet weather events, the flows are small enough to be completely captured and stored in the RTB.

Some RTBs have a first-flush compartment used to store flow with the highest level of pollutants from the first part of the storm. These pollutants include organic material, oil, sediment, salt and lawn chemicals that are picked up by the storm water as it runs off roads and lawns. Flows from this compartment are always stored and sent to the WRRF when the RTB is emptied.

GLWA adopted a four-part strategy to address CSO:

- Source reduction – reduce the amount of storm flow that enters the wastewater system.
- In-system storage – maximize the use of existing storage space in the sewer system during storms.
- Wastewater treatment plant expansion – expand capacity of primary treatment from

1.5 to 1.7 billion gallons per day to treat more flow during storms.

- End-of-pipe treatment – construct facilities to store and treat the combined sewage, preventing it from entering area waterways unless treated and disinfected.

In spite of this progress to eliminate untreated combined sewer overflows, GLWA is preparing for the next phase in combined sewer overflow treatment. This next phase will endeavor to reduce, minimize, and/or eliminate untreated CSO overflows over the next long term CSO period. Strategies for the long-term plan will focus on and further develop elements identified during the 2019 GLWA Wastewater Master Plan project.

A summary of the overall flow and treatment capacity of the GLWA CSO RTB Facilities is shown in Table 3 on the following pages.

Table 3. Flow and Treatment Capacity of GLWA CSO RTBsb

	HUBBELL - SOUTHFIELD	SEVEN MILE	PURITAN-FENKELL	CONNER CREAK	OAKWOOD
Year of Startup	1999	1999	1999	2005	2012
Drainage Area (Acres)^a	14,328	508	635	21,840	1,500
Retention Volume (MG)	22	2.2	2.8	30	9.0
In-System Storage (MG)^b	4.4	7	7	32	0
Peak Flow Rates (cfs)^c	3,200	656	845	13,962	1,660
Compartments	2	2	2	4	2
Sanitary Pump Station	No	No	Yes	No	Yes
Influent	Gravity	Gravity	Gravity	Gravity	Pumped
Effluent	Gravity				
Dewatering	Gravity / Pumped	Pumped	Gravity / Pumped	Gravity / Pumped	Gravity / Pumped
Screening	1.5-inch Catenary-Type Bar Screens	0.5-inch Open Space Centenary-Type Bar Screens	0.5-inch Open Space Centenary-Type Bar Screens	1.5-inch Centenary-Type Bar Screens	Perforated Plate Screens (6-8 mm)
Odor Control	Horizontal Wet Scrubber with Sodium Hypochlorite	Vertical Wet Scrubber with Sodium Hypochlorite	Vertical Wet Scrubber with Sodium Hypochlorite	Carbon Absorption	
Flushing	Flushing Nozzles	Tipping Buckets	Tipping Buckets	Flushing Gates	
Ventilation	Forced-Air				
Disinfection	Sodium Hypochlorite				

^a Combined wet weather flow sources drained from tributary districts (acreage) is preferentially transported to the WRRF until Primary capacity is exceeded per established Operational Protocols; residual flows are transported to CSO Facilities.

^b Tributary upstream wet weather flow volume also captured and drained to basin during events and subsequently dewatered.

^c Peak flow rates are dependent on discharge river elevation.

Conner Creek CSO RTB

Detroit’s largest CSO control facility, the Conner Creek CSO RTB eliminated three outfalls and has dramatically improved water quality in Conner Creek and the Detroit River since going into operation in November 2005. This RTB provides 62 million gallons of total storage, with 30 million gallons in the retention treatment basin and 32 million gallons in upstream structures. High-speed mixers are used to rapidly disinfect flows and achieve the required fecal coliform limits. This facility was sized to provide five minutes of detention for settling and disinfection for the peak flow from the 10-year, one-hour storm.

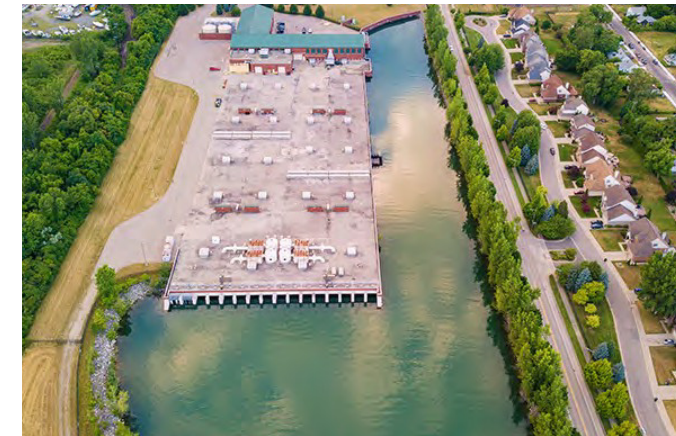

Figure 40. Conner Creek CSO RTB

Hubbell-Southfield CSO RTB

The Hubbell-Southfield CSO RTB is one of GLWA’s most active, longest operating CSO facilities and the largest on the Rouge River. Since August 1999, it has been effectively capturing and treating combined sewage through screening, settling and disinfection to meet discharge permit requirements that protect public health. Sized to fit into the available land and site constraints, the basin has a 22-million-gallon storage capacity. Located next to the Tournament Players Championship Golf Course (TPC) in Dearborn, this RTB serves as an example of how these facilities can be good neighbors and blend in with the surrounding environment. The facility features an innovative design component that enables three different operational modes within the RTB and prevents resuspension of solids during large storms with high flow rates.

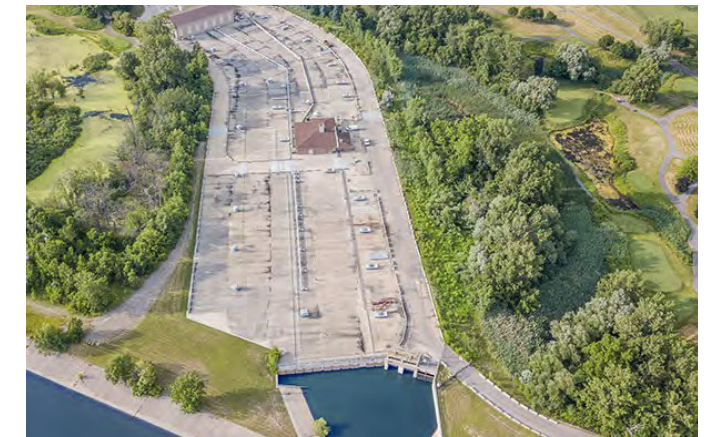

Figure 41. Hubbell-Southfield CSO RTB

Oakwood CSO RTB

The Oakwood CSO RTB was placed in service in 2012. Located on the lower portion of the Rouge River immediately south of I-75, the 9-million-gallon RTB is designed to provide CSO treatment through storage plus fine screening and disinfection. This facility includes a major influent pumping station with capacity to pump 1,800 cubic feet per second (cfs) combined sanitary and storm flow. This pumping station increases the level of service for the Oakwood District and helps to alleviate basement flooding in the upstream area.



Figure 42. Oakwood CSO RTB

Puritan-Fenkell CSO RTB

Located in Eliza Howell Park, the Puritan-Fenkell CSO RTB is the third Rouge River CSO RTB. This facility successfully demonstrated that a facility sized to provide 20 minutes of detention time for settling and disinfection of the one-year, one-hour storm event peak flow is sufficient to meet protection of public health standards. The 2.8-million-gallon facility became operational in August 1999, and eliminated two untreated CSO outfalls.



Figure 43. Puritan-Fenkell CSO RTB

Seven Mile CSO RTB

The Seven Mile CSO RTB was constructed at the same time as the Hubbell-Southfield and Puritan-Fenkell CSO RTBs with funding from the Rouge River National Wet Weather Demonstration Program. Located on the northeast corner of West Seven Mile Road and Shiawassee Drive, the roof of the basin also serves as the parking lot for the Greater Grace Temple. The RTB is sized to provide 30 minutes of detention time for settling and disinfection of the one-year, one-hour storm event peak flow. It has a 2.2-million-gallon storage capacity. Two untreated CSO outfalls were eliminated when it went into operation in 1999.



Figure 44 Seven Mile CSO RTB

Combined Sewer Overflow Screening and Disinfection Facilities

A CSO Screening and Disinfection Facility (SDF) treats combined sewage. These are called flow-through facilities, and use fine screens to remove solids and sanitary trash from the combined sewage. Flows are injected with Sodium Hypochlorite disinfectant to kill bacteria before discharging to receiving waters (Detroit and Rouge Rivers). Materials removed by the screens are sent to the WRRF or hauled to a landfill for proper disposal. A summary of the overall flow and treatment capacity of the GLWA CSO SDFs is shown in Table 4 below.

Table 4. Flow and Treatment Capacity CSO Screening and Disinfection Facilities

COMPONENT CRITERIA	BABY CREEK	LEIB	ST. AUBIN
In Service Date	2007	2002	2002
Peak Hydraulic Capacity ^a	5,100 cfs	2,000 cfs	310 cfs
Toward Treatment Capacity	140 cfs	150 cfs	Not Applicable
Screening Capacity	5,100 cfs	1,550 cfs	250 cfs
Disinfection Capacity (10 minute contact)	5,100 cfs	1,550 cfs	250 cfs
Dewatering Capacity		Static Volume in 24 hours	Static Volume in 24 hours
Influent	Gravity/Pumped	Gravity	Gravity
Effluent	Gravity	Gravity	Gravity

^a Peak hydraulic capacity is dependent on river elevations.

Baby Creek Screening and Disinfection Facility

The Baby Creek facility is a screening and disinfection facility that uses fine screens and high-rate disinfection to treat combined sewage flows that pass through it. It is located at Miller and Industrial Drive in southwest Detroit at the city limit shared with Dearborn. High-energy mixers are being used to mix sodium hypochlorite to maximize bacterial kill and minimize discharge of residual chlorine to the Rouge River. The facility is rated for 5,100 cfs treatment capacity, although treatment flow rates vary based on the river elevation. The site area includes the Woodmere Pumping Station that services a 450-acre portion of the Baby Creek tributary area.



Figure 45. Baby Creek SDF

Leib Screening and Disinfection Facility

The Leib facility was constructed to address a large outfall on the Detroit River and to demonstrate the effectiveness of fine screening (horizontal and vertical) in combination with 10 minutes of disinfection time for the design flow to meet protection of public health standards. High-energy mixers are being used to mix sodium hypochlorite to maximize bacterial kill and minimize discharge of residual chlorine to the Detroit River. The facility can treat a flow rate of up to 1,550 cfs. It began operation in 2002, and successfully achieved the required treatment levels during the demonstration period.



Figure 46. Leib SDF

St. Aubin Screening and Disinfection Facility

The St. Aubin facility was built at the same time as the Leib facility and uses the same technology. High-energy mixers are being used to mix sodium hypochlorite to maximize bacterial kill and minimize discharge of residual chlorine to the Detroit River. While St. Aubin is much smaller, with about one fifth of the treatment capacity of Leib, it is important in addressing water quality along Chene Park (which frequently hosts concerts and other events). This facility has operated successfully since 2002.



Figure 47. St. Aubin SDF

2.2. FIELD SERVICES

2.2.1. GENERAL PURPOSE

The General Purpose category within Project Category 2 and Project Category 3 in the Capital Project/General Ledger Account Numbering Protocol are necessary to identify projects that cross over multiple project categories. Projects that are not specifically attributed to one particular area will be identified here.

2.2.2. INTERCEPTOR

The Regional Wastewater Collection System (RWCS) is responsible for the conveyance of wastewater and stormwater flows to the GLWA WRRF. The collection system is the oldest part of the wastewater treatment and transportation system. Some sewers are over 130 years old and are still in service today.

The RWCS is comprised of approximately 195 miles of sewer mains. Approximately 184 miles of the mains are considered “Common Use” interceptors or trunk sewers, with the remaining 11 miles of mains being considered “Member Partner Connection” (i.e., a dedicated line connecting a suburban member partner to the GLWA WRRF with no other member partner taps to it). In addition, there are approximately 0.1 miles of force main operated and maintained by GLWA. See **Figure 51**, the map of the RWCS, and the list of all of GLWA-leased sewer main assets below. Information has been gathered in this table from best available sources, including various reference documents, as well as GIS information.

Figure 48, **Figure 49**, and **Figure 50** depict the collection system inventory by material, diameter, and decade installed/age, respectively. The collection system ranges from

12 to 348 inch in diameter with an average age of 78 years.

Most of RWCS is Concrete Pipe (72%) and Brick Pipe (23%). The majority of RWCS are typically 60 inches and larger, of which 161-169 inch (12%), 120-129 (12%), and 102-108 inch (9%) are the most common conduit diameters / heights. Detroit and the region went through several growth periods of time evidenced by the greatest periods of water main installation of the 1920s (37%), 1960s (12%) and 1930s (9%).

In recent history, a condition inspection of the Detroit River Interceptor and Outfalls was performed in 2012. A prioritized condition assessment and renewal program has been underway since 2016 on the collection system gravity mains. This effort was initiated to address the aging collection system infrastructure in a proactive and methodic fashion. Over the past two years all 184 miles of sanitary sewer interceptor has been inspected as part of this program. Follow-up repairs and inspections are being planned and are in various stages of completion.

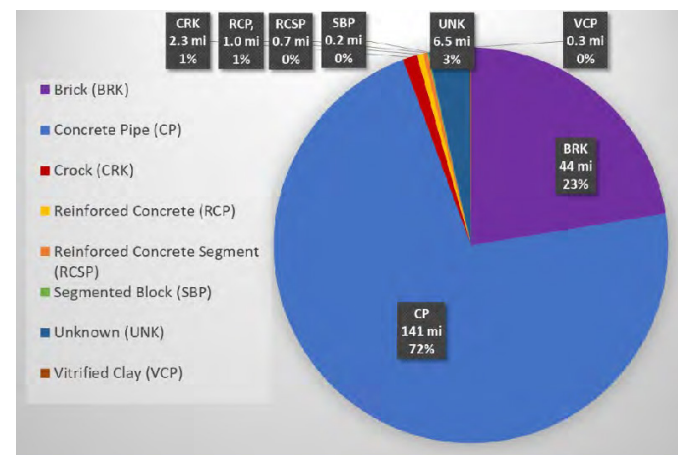

Figure 48. Collection system inventory by material

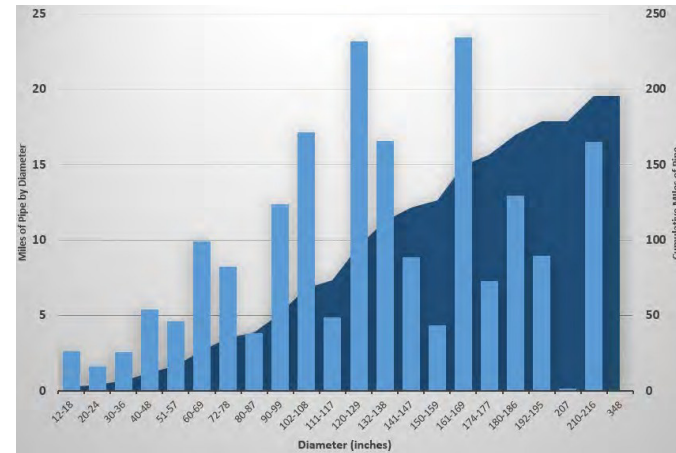

Figure 49. Collection system inventory by diameter/height

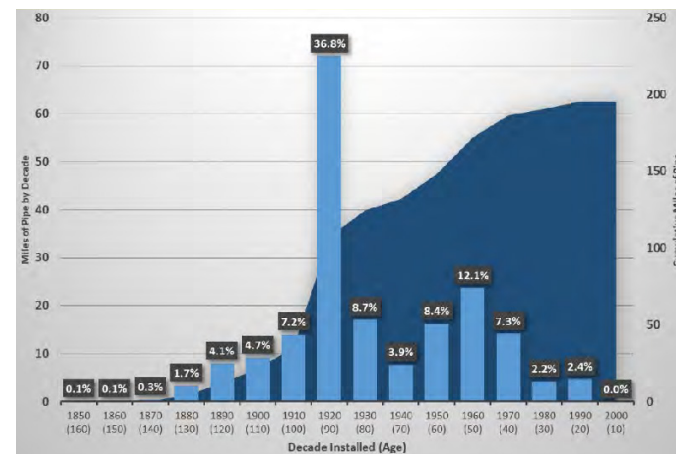
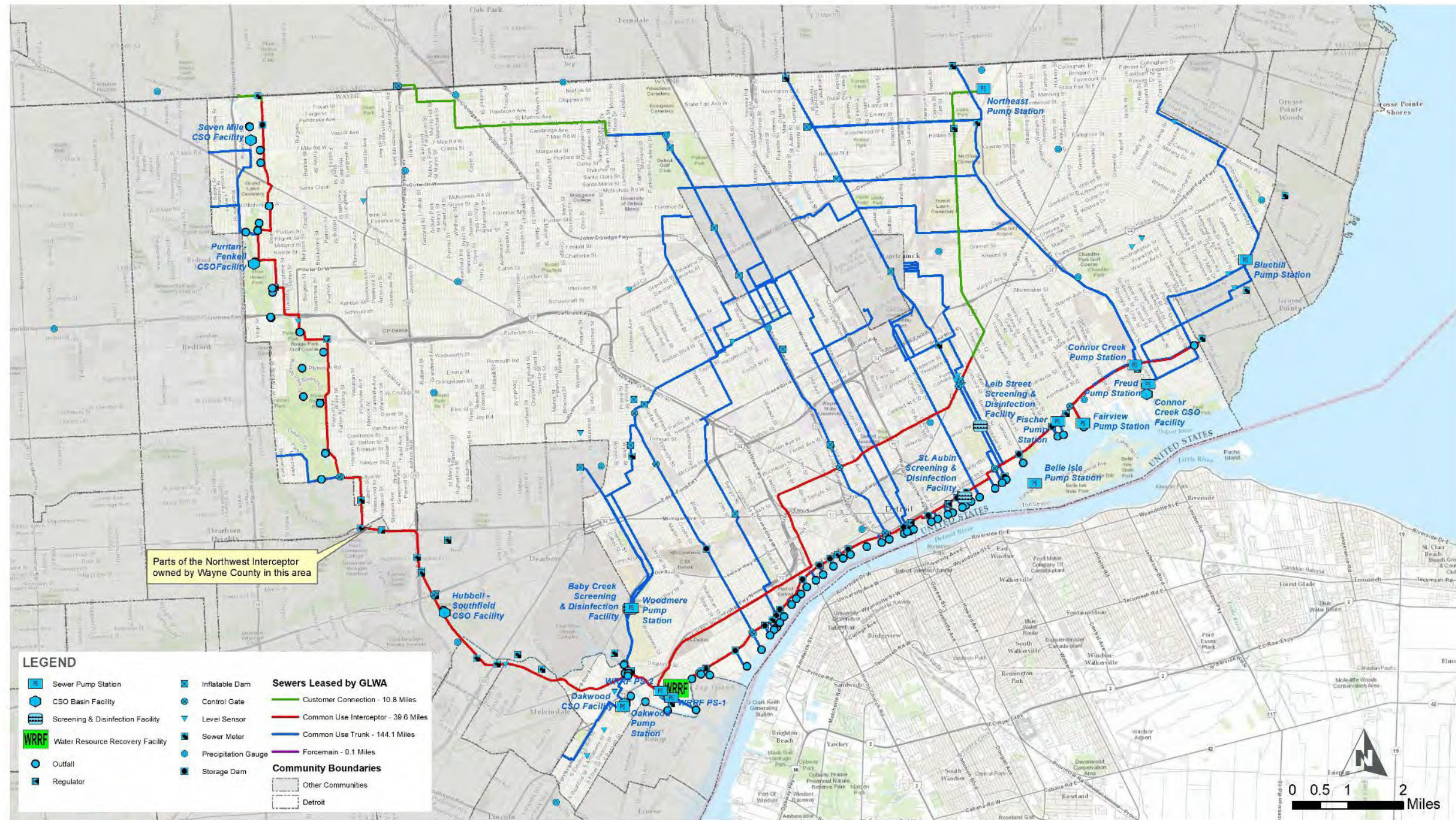

Figure 50. Collection system inventory by decade installed/age

Figure 51 depicts only those interceptors and trunk sewers operated/maintained (leased) by GLWA. The suburban communities own, operate, and maintain all of their collection system up to the points of connection to the RWCS.

There are three primary interceptors that make up the RWCS and ultimately serve all the combined drainage districts. Those interceptors are the Detroit River Interceptor (DRI), Oakwood-Northwest Interceptor (O-NWI), and North Interceptor East Arm (NI-EA). These

interceptors are shown in red/green. These primary interceptors total approximately 44 miles in length with the remaining 151 miles being trunk sewers that primarily service the City of Detroit’s 9 drainage districts.



Notes: Assets depicted on this map are based on the best available data at this time. They may not be completely accurate including spatial representations, leased statuses or attribute values. The user accepts responsibility for accuracy of any referenced information, spatial or otherwise.

GLWA LEASED SEWER ASSETS COLLECTION SYSTEM

Figure 51. Sewer interceptors and trunk sewers operated/maintained by GLWA

Table. 5 Sewer interceptors and trunk sewers operated/maintained by GLWA

SEWER NAME	TYPE	LENGTH (MILES)	SIZE	MATERIAL	DRAINS TO INTERCEPTOR	YEARS CONSTRUCTED (YEAR - YEAR)	AGE RANGE (YEARS - YEARS)	AVERAGE AGE	INSPECTION MONTH / YEAR
6 Mile Sewer	Trunk	5	9'-10.5'	Concrete / Brick	DRI	1921-1927	98-92	95	9/2017 - 1/2018
6 Mile Sewer East	Trunk	0.4	10.5'	Concrete	DRI	1921-	98-	98	9/2022
6 Mile Sewer West	Trunk	0.5	6.25'-7.25'	Concrete	O-NWI	1930-	89-	89	12/2022
7 Mile Sewer	Trunk	4.2	5.5'-11.5'	Concrete	DRI & NIEA	1921-1924	98-95	97	8/2017-11/2017
7 Mile Sewer West	Trunk	0.8	9.25'	Brick	O-NWI	1931-	88-	88	10/2017
7 Mile Sewer West Relief	Trunk	0.7	10'	Concrete	DRI & NIEA	1965-1967	54-52	53	8/2017-10/2017
7 Mile Sewer East Relief	Trunk	3.2	9'-13.75"	Concrete	DRI	1960-1962	59-57	58	10/2017
8 Mile-Centerline Sewer / Connors Ave. Arm	Trunk	0.7	1.5'-8.5'	Concrete / Brick / Unknown	DRI	1928-1930	58-	58	4/2018-8/2018
Ashland Relief Sewer	Trunk	1.7	11.5'-16'	Concrete	DRI	1961-	81-	81	11/2016-12/2016
Baby Creek (Dry Weather Line)	Trunk	4.3	3'	Concrete	O-NWI	1938-	57-	57	12/2017-1/2018
Baby Creek (Wet Weather Line)	Trunk/CSO Storage	4.3	14.5'x17.5'	Concrete	N/A - Rouge River, Miller Rd Gate Outfall	1962-	97-	97	12/2017-1/2018
Bates St. Sewer	Trunk	5.4	1' - 13.5' 3'x4.5' (Box)	Concrete / Brick / Clay / Unknown	DRI	1922-	90	90	9/2017-10/2017
Berg Sewer	Customer Connection	0.1	1.75'	Concrete / Brick	O-NWI	1929-	107-96	102	9/2017-10/2017
Clark Sewer, Morell St. Sewer, Extension to Morrell, Tuxedo Ave. Sewer	Trunk	8.2	5'-14'	Concrete / Brick / Unknown	DRI	1912-1923	65-62	64	8/2017-10/2017
Conant-Mt. Elliot Relief Sewer	Trunk	8.2	10.5'-16.25'	Concrete	DRI & NIEA	1954-1957	91-97	94	9/2017-10/2017
Connors Creek Enclosure	Trunk	11.5	12'x17.5' (Box) 12.9'x17.5' (Box)	Concrete / Brick	DRI	1922-1928	49-	49	9/2016-12/2017
Dequindre Interceptor	Trunk	0.9	9'	Concrete	DRI & NIEA	1970-	98-92	95	-
Detroit River Outfalls	Outfalls	10.7	1'-15.5' (Varying Shapes)	Concrete / Brick / Clay / Unknown	Detroit River	1885-1967	134-52	93	10/2016
Detroit River Interceptor (DRI)	Interceptor	12.7	6'-16'	Concrete / Brick	WRRF	1913-1939	106-80	93	7/2012-10/2016
East Jefferson Relief Sewer	Trunk	1.1	14'	Concrete	DRI	1927-	92-	92	12/2016
Elmer-Ternes Sewer (West End Relief)	Trunk	2.6	14.5' 14.5x14.5' (Box)	Concrete	O-NWI	1962-1965	57-54	56	8/2017-10/2017
Evergreen-Farmington Connection	Customer Connection	4.8	8'	Concrete	DRI & NIEA	1991-	28-	28	-

SEWER NAME	TYPE	LENGTH (MILES)	SIZE	MATERIAL	DRAINS TO INTERCEPTOR	YEARS CONSTRUCTED (YEAR - YEAR)	AGE RANGE (YEARS - YEARS)	AVERAGE AGE	INSPECTION MONTH / YEAR
First-Hamilton Relief Sewer	Trunk	8.8	7'-15.5' 2.7'x4' - 10'x10.5' (Box)	Concrete	DRI & NIEA	1956-1970	63-49	56	8/2017-10/2017
Fisher Ave. Storm Sewer	Trunk	.5	10.5'x13.75'	Concrete	DRI / Detroit River	1928-1965	91-54	73	-
Fort Street Sewer	Trunk	2.7	2'-10'	Concrete / Crock / Brick / Segmented Block	O-NWI	1924-1939	95-80	88	9/2017-4/2018
Fox Creek Relief Sewer, Cadieux Road Sewer	Trunk	4	9.25'-16'	Concrete	DRI	1923-1953	96-66	81	11/2016-12/2016
Jos. Campau Sewer	Trunk	5	3.5'-11.5'	Concrete / Brick	DRI	1921-1957	98-62	80	9/2017-11/2017
Joy Road Sewer, Highland Park Sewer - Edison Ave. Arm, Highland Park Arm	Trunk	4.1	8.25'-14'	Concrete / Brick	DRI & NIEA & O- NWI	1922-1975	97-44	71	9/2017-11/2017
Linwood Ave. Sewer, Lateral Sewer - Puritan & Linwood - Puritan Ave. Arm	Trunk	3.1	1.25'-9.5' 3'x4.5' (Box) 3.3'x5' (Box)	Concrete / Brick / Clay	DRI	1919-1921	100-98	99	9/2017-2/2018
Livernois Relief Sewer	Trunk	5	3'-10.5' 10'x10' (Box)	Concrete	DRI & NIEA	1949-1972	70-47	59	9/2017-10/2017
Lonyo Sewer	Trunk	3.4	13.6 14.5'x14' (Box)	Concrete / Brick	O-NWI	1922-	97-	97	9/2017
Lynch Road Sewer, Davison Ave. Sewer, Chrysler Freeway Davison Sewer Alterations, Connor Creek Connection	Trunk	4.9	5.5'-11.5'	Concrete / Brick	DRI	1920-1975	99-44	72	7/2017
Mack Avenue Relief Sewer	Trunk	2.2	9.25'-14'	Concrete	DRI	1967-	52-	52	11/2016
Mt. Elliot Ave. Sewer, Miller Road Sewer, Carrie Ave. Relief, and Laterals	Trunk	6.4	1.25'-9'	Crock / Brick	DRI	1913-1930	106-89	98	7/2017-4/2018
North Interceptor East Arm (NIEA) - Upper Portion, Northeast SPS to Gratiot	Interceptor	6.4	12'-17.5'	Concrete	WRRF & DRI	1971-1974	48-45	47	7/2015-8/2015

The RWCS serves 77 suburban communities that cover an area of 1,100 square miles. A large majority of the suburban communities are served by separated storm/sewer systems. The RWCS is comprised of 27 sewer districts representing drainage districts within the City of Detroit, drainage districts from adjoining counties/municipal districts, and various districts serving individual suburban communities. The sewer service areas served by the RWCS are as shown in **Figure 52**. Nine sewer districts: Rouge River, Hubbell, Southfield, Baby Creek, Conner Creek, Oakwood, Central City, Fox Creek, and East Jefferson.

City of Detroit Sewer Districts

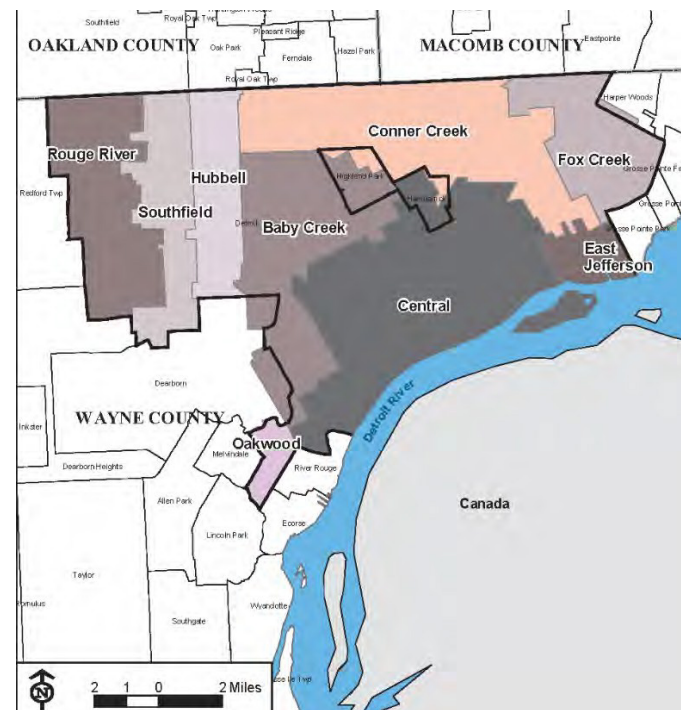

Figure 52. Sewer districts within Detroit

City of Regional Sewer Districts

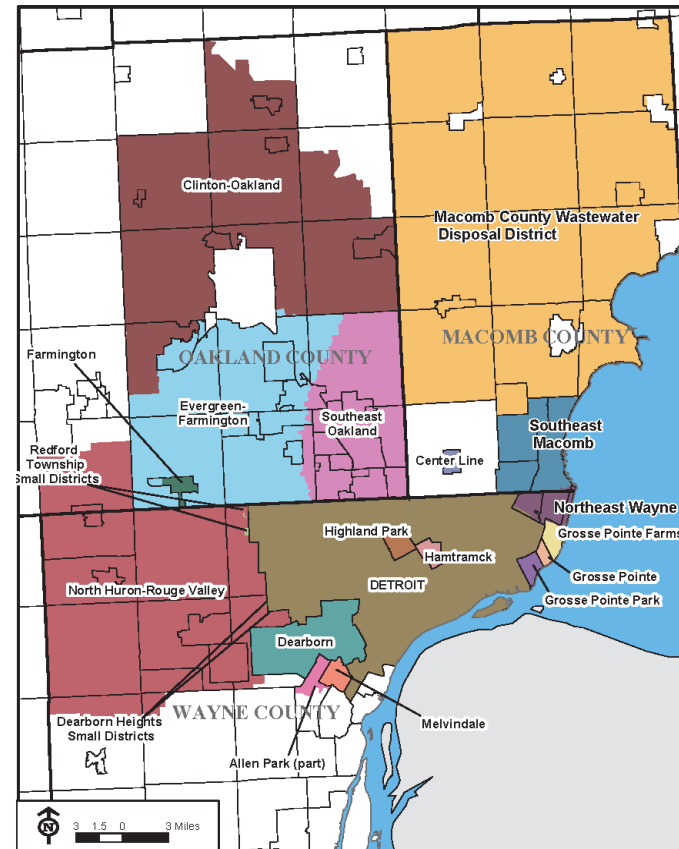

Figure 53. Sewer districts served by GLWA

Total GLWA Sewer Districts

Communities served by the varying sewer districts are provided below.

Table 6. GLWA Service Districts & Communities Served

COUNTY/CITY	DISTRICT	COMMUNITIES
Detroit	Rouge River	City of Detroit
Detroit	Hubbell	City of Detroit
Detroit	Southfield	City of Detroit
Detroit	Baby Creek	City of Detroit, Highland Park
Detroit	Conner Creek	City of Detroit, Highland Park
Detroit	Oakwood	City of Detroit, Highland Park, Hamtramck
Detroit	Central City	City of Detroit
Detroit	Fox Creek	City of Detroit
Detroit	East Jefferson	City of Detroit
Macomb	Southeast Macomb Sanitary Sewer District (SEMSD)	St. Clair Shores, East Pointe, Roseville (Through NESDS)
Macomb	Macomb County Wastewater District (part of Oakland Macomb Interceptor Drainage District)	Fraser, Sterling Heights, Clinton Twp, Harrison Twp, Shelby Twp, Utica, Macomb Twp, Waldenburn, Chesterfield, New Haven, Lenox, Ray, Washington Twp
Macomb	Centerline	City of Centerline
Oakland	Evergreen-Farmington District	Farmington Hills, Orchard Lake Village, Keego Harbor, Bloomfield Hills, Bloomfield Twp, Birmingham, Franklin, Beverly Hills, Lathrup Village, Southfield, Troy
Oakland	Southwest Oakland County District (George W. Kuhn Drainage District)	Troy, Oak park, Madison Heights, Clawson, Hazel Park, Royal Oak, Pleasant Ridge, Huntington Woods, Berkley, Royal Oak Twp, Ferndale
Oakland	Clinton Oakland District (part of Oakland Macomb Interceptor Drainage District)	West Bloomfield Twp, Waterford Twp, Lake Angelis, Auburn Hills, Rochester Hills, Rochester, Oakland Twp, Orion Twp, Village of Clarkston, Independence Twp, Orion Twp, Lake Orion, Oxford Twp, City of Oxford
Oakland	City of Farmington	City of Farmington
Wayne	Rouge Valley Sewage Disposal System (RVSDS)	City of Inkster, City of Wayne, Canton Twp, Van Buren Twp, City of Westland, Garden City, Dearborn heights, Redford Twp, City of Livonia, City of Plymouth, City of Northville, City of Novi, Novi Twp, Romulus
Wayne	Northeast Sewage Disposal System (NESDS)	Harper Woods, Grosse Pointe Shores, Grosse Pointe Woods
Wayne	Grosse Pointe Farms	Grosse Pointe Farms
Wayne	Grosse pointe Park	Grosse pointe Park
Wayne	Grosse Pointe	Grosse Pointe
Wayne	City of Dearborn	City of Dearborn
Wayne	Melvindale	Melvindale
Wayne	Allen Park	Allen Park

COUNTY/ CITY	DISTRICT	COMMUNITIES
Wayne	Redford Township	Redford Township
Wayne	Dearborn heights	Dearborn heights
Wayne	Harper Woods	Harper Woods

2.3. SYSTEM CONTROL CENTER

The Systems Control Center operates and maintains five Wastewater Pumping Stations located in the GLWA collection system that assist conveyance of wastewater and stormwater flows to the WRRF. They are Conner Sewage Pumping Station, Fairview Sewage Pumping Station, Freud Sewage Pumping Station, Northeast Sewage Pumping Station, and Oakwood Sewage Pumping Station. These facilities are described in the table below.

GLWA maintains 13 in-system storage devices throughout central Detroit and seven in-system gates throughout the west side of Detroit to maximize the storage capacity of sewers during storms. The in-system storage devices are rubber, inflatable dams located inside large trunk sewers. The in-system gates are mechanical gates located inside outfall sewers. These devices are designed to temporarily retain flows in the Sewer System during storm events up to a certain level before discharge to the river occurs. These devices operate automatically but are monitored by GLWA staff. These staff members coordinate and apply operational protocols prior to storm events to dewater the wastewater collection system and treatment facilities to maximize the available in- system storage capacity. Along with the flow control devices, the Systems Control Center team also operates and maintains many rain

gauges and level sensors throughout the RWCS.

2.3.1. GENERAL PURPOSE

The General Purpose category within Project Category 2 and Project Category 3 in the Capital Project/General Ledger Account Numbering Protocol are necessary to identify projects that cross over multiple project categories. Projects that are not specifically attributed to one particular area will be identified here.

2.3.2. WASTEWATER PUMPING STATION

Wastewater Pump Stations pump wastewater, and when necessary excess storm water, to the WRRF. Most of the wastewater collection system is gravity fed, but in low-lying areas, lift stations are necessary to lift wastewater to a higher elevation in order for flow by gravity to be possible. There are nine sewer lift stations in the wastewater collection system; an example is shown in **Figure 54**.

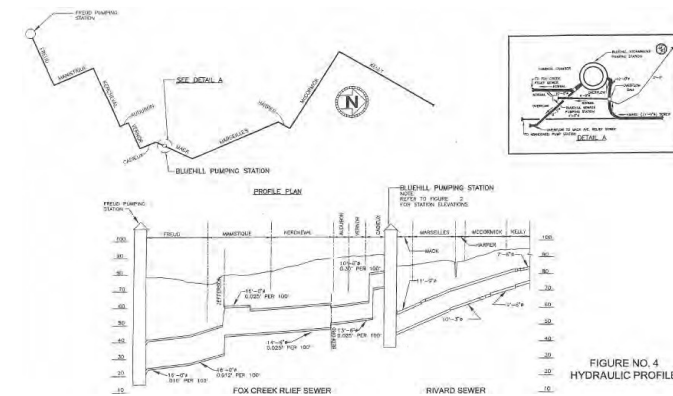

Figure 54. Hydraulic Profile at Bluehill Station

Connor Creek Pump Station

Sewage flows by gravity to the Conner Creek Pumping Station through the western and eastern East Jefferson Avenue relief sewers. These sewers are designed to carry both sanitary sewage and storm water to the Conner Creek Pumping Station wet wells. The Conner Creek Pumping Station is required because the elevation of the relief sewers is too low to allow the sewage to continue to flow by gravity to subsequent treatment facilities or to the Conner Creek CSO Basin. During normal dry weather flow, wastewater is discharged to the DRI. During wet weather, the wastewater is discharged to the Conner Creek CSO.

This station consists of a sanitary pump house, stormwater pump house, switch house, and backwater gates. During normal dry weather flow, wastewater is discharged by four sanitary pumps (two 71 MGD, one 48 MGD, and one 38 MGD) to the Detroit River Interceptor (DRI). During wet weather, eight stormwater pumps (318 MGD each) discharge combined wastewater to the Conner Creek CSO

Max Wet Well Level	74 FT
Sanitary Pumps	SN9 - 500 HP, 96 MGD SN10 - 350 HP, 96 MGD SN11 - 500 HP, 96 MGD SN12 - 200 HP, 48 MGD
Storm Pumps	ST1- 2300 HP, 320 MGD ST2- 2300 HP, 320 MGD ST3- 2300 HP, 320 MGD ST4- 2300 HP, 320 MGD ST5- 2250 HP, 320 MGD ST6- 2250 HP, 320 MGD ST7- 2300 HP, 320 MGD ST8- 2300 HP, 320 MGD

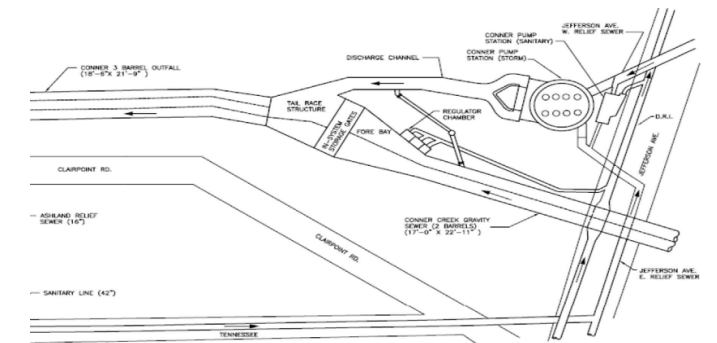

Figure 56. Schematic of Conner Creek Pump Station

Table 7. Summary of Major Rehabilitation and Improvements Projects at the Conner Pump Station

CONTRACT NO.	CONTRACT TITLE	SUMMARY OF WORK	YEAR
TW-24-A	Conner Creek	N/A.	
PC-265	Regulator Improvement-Conner Station	N/A.	
PW-212	Conner Creek Pumping Station Motor Driven Pumping Unit Nos. 5 and 6	Installation of Storm Water Pumps 5 and 6.	1947
PW-3042	Conner Creek Sanitary Pumping Station	Construction of the sanitary pump station.	1958
PC-674	Conner Station Rehabilitation	Rehabilitation of buildings at the Conner Station site and Fox Creek Backwater Gate Building. Rehabilitation of the buildings include masonry work, windows and doors, roofing and sheet metal, heating and ventilating systems, toilet facilities, lighting and electrical systems, and interior finishes. Rehabilitation of the sanitary pumps, sanitary pump motors and controls, replacement of the control switchboard for the storm water pumps, and repair the stormwater pumps. Also included are new sanitary pump isolation valves, revised suction and discharge piping, hydraulic modeling of the sanitary wet well, and replacement of stormwater sump pumps. Rehabilitation of the site shall include replacement of all roadways, curbs, sidewalks, site lighting, and demolition of the oil pump house.	5/1/2009
PC-713	Authority-Wide Instrumentation, Control and Computer Systems Program	Ovation System.	2007
DWS-828	Emergency Generators	Installed the four (4) Emergency Generators with power of 2MW.	12/1/1999
Maintenance Contract	Transformer	Replaced the powerhead on Transformer 1 and painted.	2015
PC-773	Ovation Control	Control Window upgrade from Window NT to Window 7.0.	2015
		AT&T's Wide Area Network Upgrade.	10/1/2016

Fairview Pump Station

The Fairview Pumping Station is an interceptor pumping station on the DRI, which provides about 22 feet of lift. Wastewater flow from the DRI is lifted by pumps at the Fairview Pumping Station and discharged into the downstream DRI to continue on to the Detroit WWTP. The function of this station is to pump the wastewater received in the wet well and return it as efficiently and quickly as possible to the downstream DRI. The station facilities include the influent DRI, gatehouse, and pumping station. The pumping station consists of the pump house and wet well.

Max Wet Well Level 20 FT

Sanitary Pumps	SN1 - 700 HP, 96 MGD SN2 - 700 HP, 96 MGD SN3 - 700 HP, 96 MGD SN4 - 400 HP, 48 MGD
----------------	--

Figure 57. Fairview Pump Station

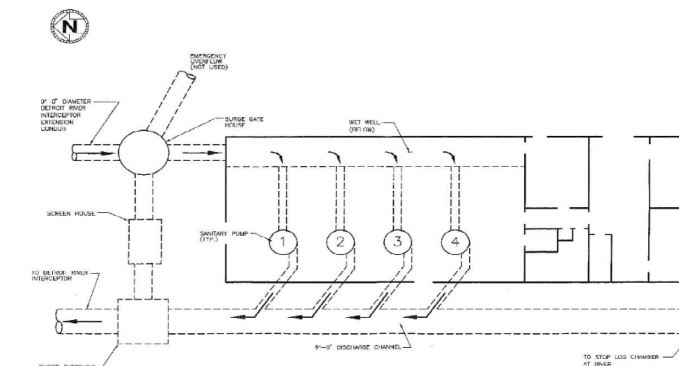

Table 8. Summary of Major Rehabilitation and Improvements Projects at the Fairview Pump Station

CONTRACT NO.	CONTRACT TITLE	SUMMARY OF WORK	YEAR
PW	Fairview Pumping Station	Construction of Fairview Pump Station.	1913
PW-679	Fairview Additions and Alterations	Modification and upgrades at Fairview Pump Station.	1949
PC-264	Modifications to Fairview Pumping Station	Modification of riser chamber and cover, stop log chamber, and surge overflow.	Set of the drawings: April 1972
PC-606	Fairview Seawall Phase II	N/A.	
PC-684	Fairview Pumping Station Rehabilitation	Replacement of the Pump 2 and associated equipment.	1995
PC-713	Authority-Wide Instrumentation, Control and Computer Systems Program	Ovation System.	2007
PC-773	Ovation Control	Control Window upgrade from Window NT to Window 7.0.	2015
		AT&T's Wide Area Network Upgrade.	October 2016

Freud Pump Station

The Freud Pump Station consists of a pump house, wet well, and transformer enclosure area. All wastewater flow to the Freud Pumping Station is combined sanitary sewage and stormwater overflow from the East Jefferson Relief Sewer. This overflow occurs when the handling capacity of the Conner Creek Station has been exceeded. The station's primary goal is to store as much wastewater as possible until it can be pumped back to the Conner Creek Pumping Station using dewatering and sanitary pumps. From the Conner Creek Station, the wastewater is transported to Detroit WRRF. The Freud Pumping Station wet well and corresponding relief sewers provide 20 million gallons of in-line storage.

Max Wet Well Level	71 FT
Sanitary Pumps	SN9 - 200 HP, 27 MGD SN10 - 200 HP, 13 MGD
Storm Pumps	ST1 - 3000 HP, 290MGD ST2 - 3000 HP, 290MGD ST3 - 3000 HP, 290MGD ST4 - 3000 HP, 290MGD ST5 - 3000 HP, 290MGD ST6 - 3000 HP, 290MGD ST7 - 3000 HP, 290MGD ST8 - 3000 HP, 290MGD



Figure 59. Freud Pump Station

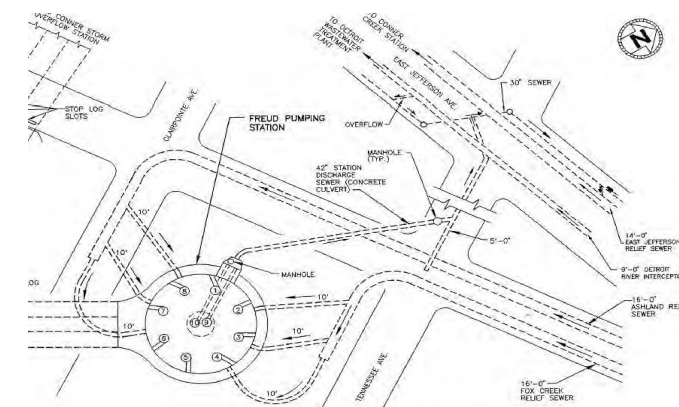

Figure 60. Freud Pump Station

Table 9. Summary of Major Rehabilitation and Improvements Projects at the Freud Pump Station

CONTRACT NO.	CONTRACT TITLE	SUMMARY OF WORK	YEAR
PC-268	Freud Station Sewerage Discharge	N/A.	
PC-664	Freud Station Improvements Pump Replacement	Replacement of pumps.	1989
PC-685	Bluehill and Freud Sewage Pumping Station Rehabilitation	Station work includes removal and replacement of switchgear and protective relaying and controls; maintaining of four bus electrical architecture; extensive rework of conduit and cables for power and control system; and other electrical work due to relocation of switchgear.	2011
PC-713	Authority-Wide Instrumentation, Control and Computer Systems Program	Ovation System.	2007
DWS-828	Emergency Generators	Installed the four (4) Emergency Generators with power of 2MW.	December 1999
PC-773	Ovation Control	Control Window upgrade from Window NT to Window 7.0.	2015
		AT&T's Wide Area Network Upgrade.	October 2016

Northeast Pump Station

The Northeast Pump Station consists of a wet well and pump house. The station receives wastewater from the 12.75-foot Corridor Interceptor. The Corridor Interceptor receives flow from the 15 Mile Interceptor, which receives flow from the Romeo Arm and Lakeshore Interceptor through the Clintondale Station. The wastewater flow to the station is nearly all sanitary sewage, with only a small portion of stormwater from suburban communities. The main goal of the pumping station is to transport wastewater to the Detroit WRRF as quickly as possible. The Northeast Pump Station is designed to pump all wastewater from the Corridor and Lakeshore connection into the 17.5-foot North Interceptor, East Arm. The wastewater flow from the North Interceptor East Arm is currently diverted to the Seven Mile Relief Sewer where it is transported by gravity through the Conant-Mt. Elliot Sewer and the DRI to the Detroit WRRF. The station receives wastewater flow from all the communities of Macomb County (except the cities of Centerline and Warren), northeastern communities of Oakland County, and all areas served by the Lakeshore Interceptor through the Clintondale Station. The pumping station currently has six sanitary pumps with a total combined capacity of 355.4 MGD.



Figure 61. Northeast Pump Station

Max Wet Well Level	26 FT
Sanitary Pumps	SN1 - 2000 HP, 96 MGD SN2 - 2250 HP, 96 MGD SN5 - 2000 HP, 65 MGD SN6 - 2000 HP, 96 MGD

Table 10. Summary of Major Rehabilitation and Improvements Projects at the Northeast Pump Station

CONTRACT NO.	CONTRACT TITLE	SUMMARY OF WORK	YEAR
PC-216	Northeast Sewage Pumping Station	The Northeast Sewage Pumping Station was built with this contract. The station consists of wet well, pump house (three sanitary pumps 1, 5, and 6), and transformer.	1969
PC-672	Northeast Sewage Station Improvements	N/A.	
PC-713	Authority-Wide Instrumentation, Control and Computer Systems Program	Ovation System.	2007
PC-736	Northeast Sewage Station-Pump No. 2 Installation	Installation of the new Pump No. 2.	May 2006 (As-built drawings)
DWS-828	Emergency Generators	Installed the three (3) Emergency Generators with power of 2MW.	December 1999
PC-773	Ovation Control	Control Window upgrade from Window NT to Window 7.0.	2015
		AT&T's Wide Area Network Upgrade.	October 2016

Oakwood Pump Station

The Oakwood Pump Station receives flow through a combined sewer collection system from Junction Chamber No. 1, which is upstream from the pumping station. Once all flows are combined at Junction Chamber No. 1, they are conveyed into the pump station through a pair of 18-foot diameter influent conduits. The combined wastewater, consisting of both sanitary and storm flows, are managed by the pump station. During normal operation, the combined wastewater is pumped by the sanitary pumps to the Detroit WRRF. When the flows into the facility exceed the capacity of these pumps during storm events, the pump station storm pumps convey any excess flow to the screenings facility and then into two 4.5 MG CSO Basins.

Max Wet Well Level	79 FT
Sanitary Pumps	SN1 - 6.4 MGD SN2 - 6.4 MGD SN3 - 6.4 MGD SN4 - 6.4 MGD
Storm Pumps	ST1 - 97 MGD ST2 - 97 MGD ST3 - 177 MGD ST4 - 177 MGD ST5 - 177 MGD ST6 - 177 MGD ST7 - 177 MGD ST8 - 177 MGD

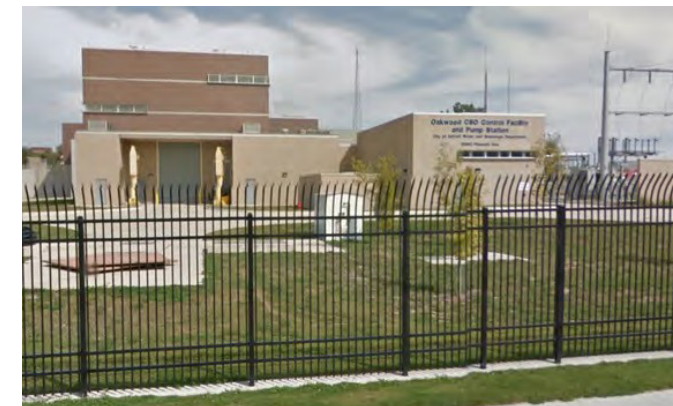

Figure 62. Oakwood Pump Station

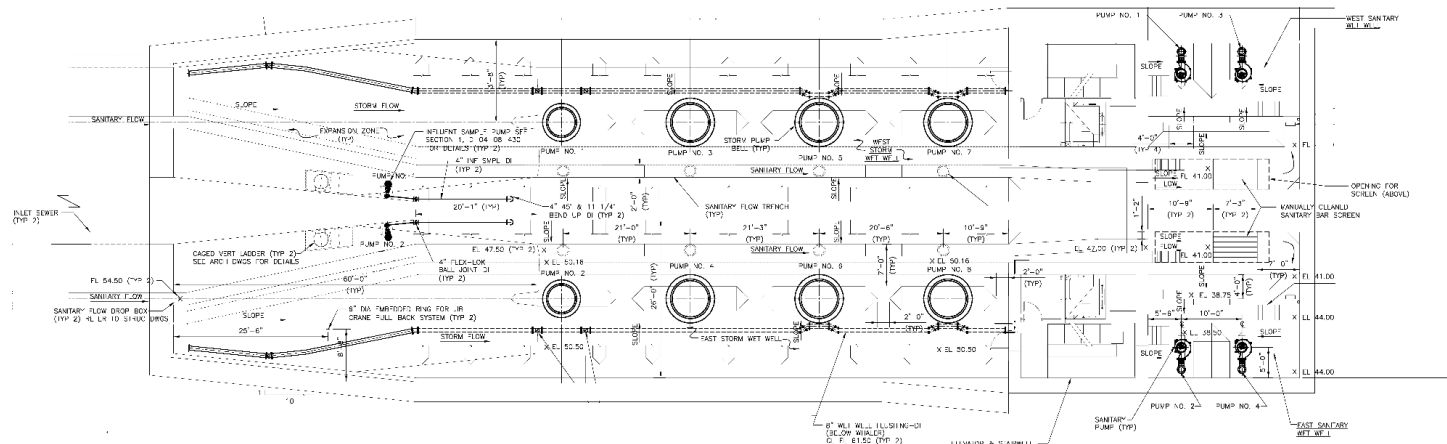

Figure 63. Oakwood Pump Station Schematic

Table 11. Wastewater Pumping Stations

NAME OF PUMP STATION	LOCATION	FUNCTION	SANITARY CAPACITY				STORM CAPACITY				NO. OF PUMPS	
			DESIGN		MAXIMUM		DESIGN		MAXIMUM		SANITARY	STORM
			MGD	CFS	MGD	CFS	MGD	CFS	MGD	CFS		
Conner / GLWA	12244 East Jefferson, Detroit	Sanitary / Storm	158.4	245	229.5	355	2226	3444	2544	3936	4	8
Fairview / GLWA	202 Parkview, Detroit	Sanitary	242.3	375	339.3	525	-	-	-	-	4	-
Freud / GLWA	12300 Freud, Detroit	Sanitary / Storm	12.96	20	35.64	55	2031	3143	2322	3592	2	8
Northeast / GLWA	11000 East Eight Mile, Detroit	Sanitary	162	251	258.4	400	-	-	-	-	4	-
Oakwood / GLWA	12330 Sanders, Detroit	Sanitary / Storm	13	20	26	40	246.9	382	315.4	488	4	8
Puritan-Fenkell / GLWA	Fenkell East of Telegraph, Detroit, MI 48223	Sanitary Pumps	1.4	2.2	2.8	4.4	-	-	-	-	2	-

2.3.3. IN SYSTEM DEVICES (DAMS, ISD'S) LEVEL SENSOR (LS)

Level sensors detect the level of liquid in the sewers. This information is used to determine the best way to store stormwater, locate possible sewer overflows, and monitor dry weather wastewater pumping operations. There are 25 sewer level sensors located and monitored throughout the collection system. Overall, there are more than 150 level sensors in the entire System. An example is shown in Figure 64.

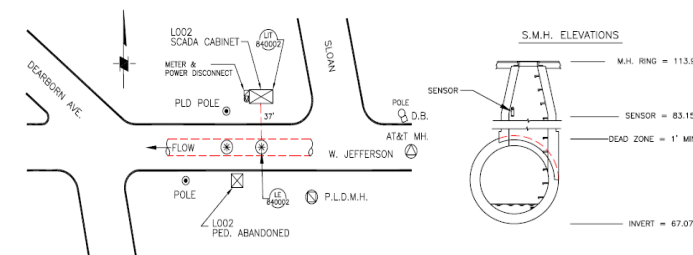

Figure 64. Example of a level sensor at West Jefferson and Sloan

Inflatable Storage Dam (ISD)

Inflatable Storage Dams, as illustrated in Figure 65, are utilized to detain upstream sewage in order to regulate flows to the WRRF. The dams can be remotely deflated and inflated as necessary.

Valve Remote (VR)

The GLWA Wastewater conveyance system has 17 Valve Remote (VR) gate locations. At these locations, one or more gates are used to selectively load the interceptors, provide in-system storage and route the flow. These gates are operated locally and remotely from the SCC during wet weather periods. During dry weather, remotely controlled gates are opened to direct flow to the interceptors, and during wet weather they are typically closed when the flow in the interceptors reach predetermined levels.

Some are operated by electric operators, but the majority of them are operated by hydraulic units (SCUBA). Most of these gates were installed in the 1970s and rehabilitated in 1998 under PC-695. Average life expectancy is 20 to 35 years. An example of a valve remote location is shown in Figure 66.

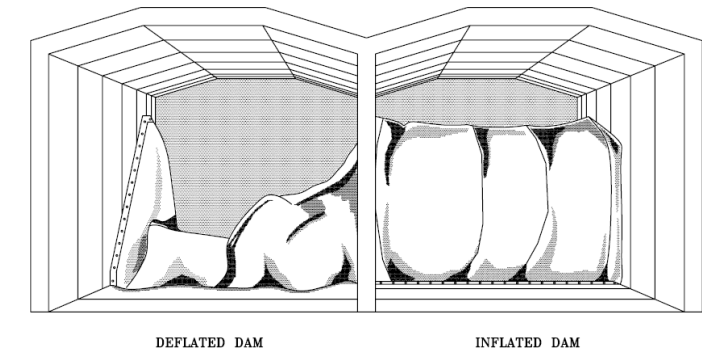

Figure 65. Inflatable dam illustration

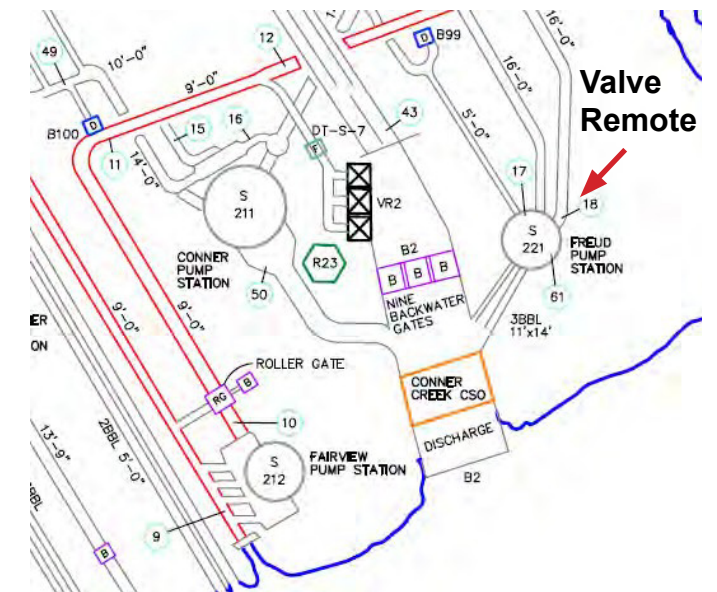

Figure 66. Example of VR located at Conner Pump Station

Precipitation Gage

IA precipitation gauge (PG, see **Figure 67**) measures the amount of liquid precipitation over a set time period. Ovation, the Authority's Supervisory Control and Data Acquisition system, reports the precipitation data to aid the operation of the collection system and minimize combined sewer overflows during storm events. Thirty-three tipping bucket rain gauges are installed throughout the service area.

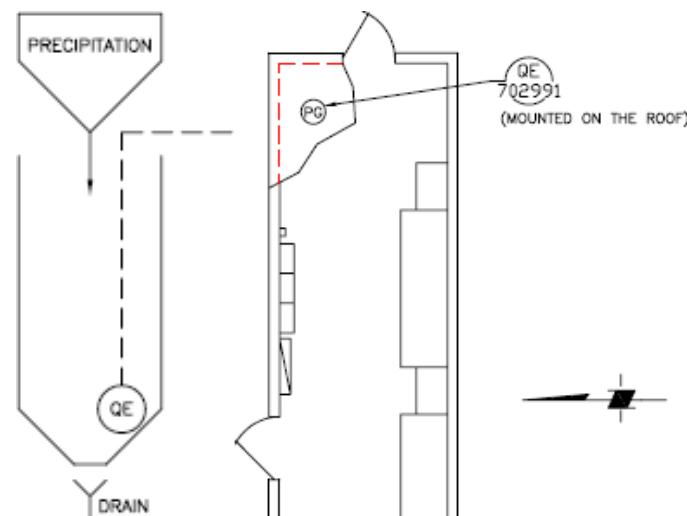

Figure 67. Example of Precipitation Gauge mounted on roof at Schoolcraft Pump Station

2.4. METERING

The System Analytics and Meter Operations Group is responsible for maintenance and operation of numerous remote assets used in the metering of wastewater, as well as the communication network used to transmit data from the metering locations to the head end.

The System Analytics and Meter Operations Group maintains assets at 46 sewer meter locations. Each of these locations contain equipment that is located in a control cabinet, as well as assets that are located in meter

vaults. The assets that are housed in the control cabinet include Remote Terminal Units, radios, flow transmitters and level transmitters. The assets that are housed in the meter vault include flow meters and level sensors.

In addition to metering equipment, the System Analytics and Meter Operations Group maintains a 900MHz telemetry network and a Greater Detroit regional sewer system (GDRSS). The 900 MHz telemetry network is composed of 445 repeater sites. Each repeater location consists of radios and antennas. The GDRSS system collects flow and depth information from GLWA sewerage meters in five-minute increments and from rain gauges in 15-minute increments. The GDRSS portal provides a web-based interface that displays meter data (collected the day before) in both graphical and tabular formats in increments of five minute, hourly, daily, monthly, and yearly intervals. Data can be exported for off-line examination. Billing reports can be reviewed for member partner analysis, as well as precipitation data.

2.5. GENERAL PURPOSE

The General Purpose category within Project Category 2 and Project Category 3 in the Capital Project/General Ledger Account Numbering Protocol are necessary to identify projects that cross over multiple project categories. Projects that are not specifically attributed to one particular area will be identified here.

2.6. PROGRAMS

Programs consist of the replacement and/or rehabilitation of specific capital asset on an ongoing or reoccurring basis. The program

scope and/or projected expenses may vary from year-to-year, depending on the needs identified within the program, and as newly established programs develop consistent schedules, requirements and history over time. Although not typically identified in the CIP future years projected expenses, these programs will typically be funded in perpetuity. The numbering structure of the "Program" category is slightly different in order to allow up to 99 separate projects to be attributable to each program. As discussed previously, these projects identified under a parent program will be issued a CIP number, however will be displayed within the CIP as a phase of the overall parent program.

APPENDIX D

3. CENTRALIZED SERVICES

3.1. INFORMATION TECHNOLOGY

Information Technology (IT) at GLWA provides centralized technology implementation, support and services across all business functions. This includes infrastructure and cloud technologies, software and applications, desktop and computing hardware, System security, portfolio and project management services, technology forecasting and budgeting management, as well as print services and document management. The goal of the IT team is to provide reliable and forwardthinking technologies that meet the needs today, and in the future, of GLWA's various business groups, enabling them to realize their goals and make processes more effective and efficient.

3.1.1. GENERAL PURPOSE

The General Purpose category within Project Category 2 and Project Category 3 in the Capital Project/General Ledger Account Numbering Protocol are necessary to identify projects that cross over multiple project categories. Projects that are not specifically attributed to one particular area will be identified here.

3.1.2. SERVICE DELIVERY

The Service Delivery Group provides core technology support services, including troubleshooting, desktop and laptop configuration, software installation, mobile device management, smart boards, and printers/scanners. This group also provides physical document management services, in addition to full print shop services. Projects in this area include workstation computing replacements and upgrades, software and system replacements and purchases, mobile computing technologies, printers, scanners and

other all in ones devices.

3.1.3. INFRASTRUCTURE

The Infrastructure Group provides administration and continuous monitoring of the GLWA business network, Internet services, data center, storage, and servers. It maintains Intermediate Distribution Facilities (IDF) and Main Distribution Facilities (MDF) across more than 40 facilities spanning the region. It also provides telephony services and all wireless internet access points. Projects that fall within this group work to improve network and telecommunications infrastructure, server hardware and systems, storage devices and related hardware, enterprise Active Directory and Office 365 infrastructure and licensing.

3.1.4. ENTERPRISE APPLICATIONS

The Enterprise Applications Group monitors and manages applications that are used by the entire organization and may be public and/or forward facing, web-based and cross-functional. These include the Geographic Information System (GIS), public website, internal (Intranet) Sharepoint site, enterprise content management systems, business intelligence, reporting analytics (KPIs), and Legistar. Projects in this group include system replacements and/or upgrades, and new application implementations.

3.1.5. BUSINESS APPLICATIONS

The Business Applications Group monitors and manages line of business applications, including database administration, for Oracle WAM (Asset Management), ServiceLink, BS&A Financials, Ceridian DayForce, LIMS/PIMS, and many other specialized software packages designed to help individual business groups improve data management and daily

operations. Projects in this group include system replacements and/or upgrades, and new application implementations.

3.1.6. SECURITY

The Enterprise Technology Security Group provides secure infrastructure support, administration, monitoring and training for network and computing security across the Authority. It participates in and supports Homeland Security initiatives and exercises, and participates in other desktop security efforts to ensure breaches are monitored, repelled and remediated on a continuous basis. Projects in this area provide additional security features, penetration testing, disaster recovery planning and implementation, and security training.

3.1.7. PROJECT MANAGEMENT OFFICE

The Program Management Office provides various administrative and strategic functions, including overall portfolio and project management, budgeting and forecasting, policy development and strategic planning, and shared services administration. Projects that fall within this group will strengthen the overall management of technology implementations at GLWA, including but not limited to project management software and systems, process and workflow development, analysis, and strategic planning.

3.2. FLEET

The Fleet Group is responsible for efficiently and effectively maintaining all GLWA Fleet and Fleet-related equipment. The Fleet Group provides the vehicles and proper equipment for GLWA staff to accomplish their required work. The vehicles and equipment acquisition,

disposal, record management, inventory and maintenance are accomplished through coordination with the DWSD Garage. All vehicles must be kept in a safe and proper manner in order to provide GLWA staff with reliable equipment to accomplish their work.

3.3. FACILITIES

The Facilities Group is responsible for efficiently and effectively maintaining all GLWA facilities and structures. The facilities house the operations of GLWA and must remain clean, secure, environmentally safe and attractive. All systems must operate in a proper and acceptable manner in order to provide a clean and safe working environment for staff, visitors and member partners. The group's objectives are accomplished by maintenance mechanics with specific skills in various trades, team leaders, administrative staff, and a manager.

3.4. SECURITY

The Water and Wastewater Systems are vulnerable to a variety of security breaches and attacks. If these breaches/attacks were realized, the result could be large numbers of illnesses or casualties and/or a denial of service that would also affect public health and economic vitality. Critical services such as firefighting and healthcare (hospitals), and other dependent and interdependent sectors, would suffer negative consequences from a denial of service from the Water and Wastewater Systems. GLWA's critical security systems, both physical and electronic, require continual upgrade and replacement to minimize the ever-present threats to GLWA staff and infrastructure.

3.5. ENERGY MANAGEMENT

The Energy Management Team has been very active in pursuing new solutions for GLWA to improve operational efficiency with new concepts and technologies to achieve sustainability. Much of the team's current work revolves around auditing existing facilities, evaluating equipment, studying various processes and developing an overall understanding of the Authority's energy consumption. Many of these initial studies, pilot projects, and evaluations will directly result in future capital investments. To ensure long-term sustainability, the Energy Management Team is in the process of developing a Strategic Energy Plan that will detail the challenges facing GLWA, establish goals and identify the methodology for measuring success. The Energy Management Group continues to work alongside GLWA's Business Intelligence staff to collect and compile energy consumption data. The effort is evolving from the original concept of monitoring pumps' electric consumption to a broader vision of modeling the entire set of business activities that bring value to our member partner communities. As this specifically relates to energy management, it is anticipated that consumption data will be compiled across multiple business areas to enable the cross-referencing between business areas by using a single data warehouse. This allows for flexibility in data mining, dashboard construction and process tracking. The results of many of these initiatives will allow the team to identify specific, prioritized areas within the Authority for future capital investment to improve efficiency.

3.6. ENGINEERING

Overall engineering services required because

of emergencies, immediate investigations, evaluations, and support to ensure continued operation and the highest level of service will typically be charged against projects and programs within this category. In addition, the engineering work performed will directly result in capital projects. Several categories exist that are typically needed in this manner. These categories are general engineering services, geotechnical services and CIP implementation services.

3.8. PROGRAMS

Programs consist of the replacement and/or rehabilitation of specific capital asset on an ongoing or reoccurring basis. The program scope and/or projected expenses may vary from year-to-year, depending on the needs identified within the program, and as newly established programs develop consistent schedules, requirements and history over time. Although not typically identified in the CIP future years projected expenses, these programs will typically be funded in perpetuity. The numbering structure of the "Program" category is slightly different in order to allow up to 99 separate projects to be attributable to each program. As discussed previously, these projects identified under a parent program will be issued a CIP number, however will be displayed within the CIP as a phase of the overall parent program.

APPENDIX D

4. GLOSSARY

BCE	Business Case Evaluations	ISD	In System Storage Device	PLC	Programmable Logic Controller	WSC	West Service Center
BDF	Biosolids Dryer Facility	IT	Information Technology	PLD	Programmable Logic Device	WTP	Water Treatment Plant
BGD	Billion Gallons per Day	ITS	Information Technology and Services	PRV	Pressure Reducing Valve	WWP WTP	Water Works Park Water Treatment Plant
BPS	Booster Pumping Station	IWC	Industrial Waste Control	PS	Pump Station	WWTP	Wastewater Treatment Plant (old terminology)
CB	Construction Bond	LCR	Lead and Copper Rule	RAS	Return Activated Sludge		
CCR	Consumer Confidence Rule	LED	Light-Emitting Diode	RRO	Rouge River Outfall		
CCTV	Closed-Circuit Television	LEL	Lower Explosive Limit	RRO-2	Rouge River Outfall No. 2		
CFS	Cubic Feet Per Second	LIMS/PMIS	Laboratory Information Management System/ Project Information Management System	RTB	Retention Treatment Basins		
CIP	Capital Improvement Plan	LH WTP	Lake Huron Water Treatment Plant	RVSDS	Rouge Valley Sewerage Disposal System		
CMG	GLWA Capital Management Group	MACP	Manhole Assessment Certification Program	RWCS	Regional Water Transmission System		
COF	Central Offload Facility	MBO	Master Bond Ordinance	SAMO	GLWA System Analytics and Meter Operations		
CSF	Central Services Facility	MCC	Motor Control Centers	SCADA	Supervisory Control And Data Acquisition (GLWA uses Ovation brand)		
CSO	Combined Sewer Overflow	MDEQ	Michigan Department of Environmental Quality	SCC	Systems Control Center		
CTA	Common To All	MDF	Main Distribution Facilities	SCP	Small Capital Projects		
CWA	Clean Water Act	MG	Million Gallons	SCUBA	Self-Contained Universal Bi-directional Actua- tor		
DDOT	Detroit Department of Transportation	MGD	Million Gallons per Day	SDF	Screening and Disinfection Facility		
DE	Debt Eligible	NAB	New Administration Building at the WRRF	SWDA	Safe Drinking Water Act		
DI	Ductile Iron	NASSCO	National Association of Sewer Service Compa- nies	SFE	Secondary Final Effluent		
DRI	Detroit River Interceptor	NE WTP	Northeast Water Treatment Plant	SFP	Sludge Feed Pump		
DRO	Detroit River Outfall	NEC	National Electric Code	SOW	Scope of Work		
DTPD	Dry Tons Per Day	NESDS	Northeast Sewerage Disposal System	SPW WTP	Springwells Water Treatment Plant		
DWRF	Drinking Water Revolving Fund	NIEA	North Interceptor East Arm	SRP	Scheduled Replacement Program		
DWSD	Detroit Water and Sewerage Department	NPDES	US EPA National Pollutant Discharge Elimina- tion System	SW WTP	Southwest Water Treatment Plant		
DWSD-R	Specifying the new, Detroit-focused Detroit Water and Sewerage Department	NPL	US EPA National Priorities List	T&O	Taste and Odor		
EPA	United States Environmental Protection Agency	O&M	Operations & Maintenance	TAC	Technical Advisory Committee		
GIS	Geographic Information System	OEM	Original Equipment Manufacturer	TCR	Total Coliform Rule		
GLWA	Great Lakes Water Authority	O-NWI	Oakwood-Northwest Interceptor	TPC	Tournament Players Championship Golf Course in Dearborn		
GPS	Global Positioning System	OSHA	Occupational Safety and Health Administration	VFD	Variable Frequency Drive		
HVAC	Heating, Ventilation, and Air Conditioning	OWI	Oakwood Interceptor	VR-Gates	Valve Remote Gates		
I&C	Instrumentation & Controls	PAC	Powdered Activated Carbon	WAMw	Work and Asset Management		
I&E	Improvement & Extension	PACP	Pipeline Assessment Certification Program	WMP	Water Master Plan		
IDF	Intermediate Distribution Facilities	PCCP	Pre-Stressed Concrete Cylinder Pipe	WMPU	Water Master Plan Update		
IGA	Investment Grade Audit	PEAS	Primary Effluent to Activated Sludge	WRRF	Water Resource Recovery Facility		
ILP	Intermediate Lift Pumps						